

## N-Channel Enhancement Mode Power MOSFET

**(Pb)** Lead(Pb)-Free

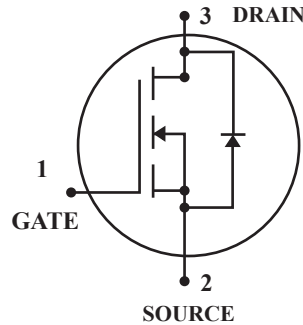

**DRAIN CURRENT**  
**5.3 AMPERS**  
**DRAIN SOURCE VOLTAGE**  
**20 VOLTAGE**

### Features:

- \*Super High Dense Cell Design For Low  $R_{DS(ON)}$   
 $R_{DS(ON)} < 90m\Omega @ V_{GS} = 12V$
- \*Rugged and Reliable
- \*Capable of 2.5V Gate Drive
- \*Simple Drive Requirement
- \*SOT-23 Package

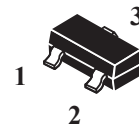

**SOT-23**

### Applications

- \*Power Management in Notebook Computer
- \*Portable Equipment
- \*Battery Powered System

### Maximum Ratings ( $T_A = 25^\circ C$ Unless Otherwise Specified)

Rating	Symbol	Value	Unit
Drain-Source Voltage	$V_{DS}$	20	V
Gate-Source Voltage	$V_{GS}$	$\pm 12$	
Continuous Drain Current <sup>3</sup> , $V_{GS} @ 4.5V (T_A = 25^\circ C)$ $V_{GS} @ 4.5V (T_A = 70^\circ C)$	$I_D$	5.3	A
		4.3	
Pulsed Drain Current <sup>1,2</sup>	$I_{DM}$	10	
Total Power Dissipation ( $T_A = 25^\circ C$ )	$P_D$	1.38	W
Maximum Junction-ambient <sup>3</sup>	$R_{\theta JA}$	90	$^\circ C/W$
Operating Junction and Storage Temperature Range	$T_J, T_{stg}$	$-55 \sim +150$	$^\circ C$

### Device Marking

WTC2306=2306

## Electrical Characteristics ( $T_A = 25^\circ\text{C}$ Unless otherwise noted)

Characteristic	Symbol	Min	Typ	Max	Unit
----------------	--------	-----	-----	-----	------

### Static

Drain-Source Breakdown Voltage $V_{GS}=0, I_D=250\mu\text{A}$	$V_{(BR)DSS}$	20	-	-	V
Gate-Source Threshold Voltage $V_{DS}=V_{GS}, I_D=250\mu\text{A}$	$V_{GS(Th)}$	0.5	-	1.2	
Gate-Source Leakage Current $V_{GS} = \pm 12\text{V}$	$I_{GSS}$	-	-	$\pm 100$	nA
Drain-Source Leakage Current ( $T_J=25^\circ\text{C}$ ) $V_{DS}=20\text{V}, V_{GS}=0$	$I_{DSS}$	-	-	1	$\mu\text{A}$
Drain-Source Leakage Current ( $T_J=70^\circ\text{C}$ ) $V_{DS}=16\text{V}, V_{GS}=0$		-	-	10	
Drain-Source On-Resistance $V_{GS}=10\text{V}, I_D=5.5\text{A}$ $V_{GS}=4.5\text{V}, I_D=5.3\text{A}$ $V_{GS}=2.5\text{V}, I_D=2.6\text{A}$ $V_{GS}=1.8\text{V}, I_D=1.0\text{A}$	$R_{DS(on)}$	-	-	30 35 50 90	$\text{m}\Omega$
Forward Transconductance $V_{DS}=5\text{V}, I_D=5.3\text{A}$	$g_{fs}$	-	13	-	S

### Dynamic

Input Capacitance $V_{GS}=0\text{V}, V_{DS}=15\text{V}, f=1.0\text{MHz}$	$C_{iss}$	-	603	-	pF
Output Capacitance $V_{GS}=0\text{V}, V_{DS}=15\text{V}, f=1.0\text{MHz}$	$C_{oss}$	-	144	-	
Reverse Transfer Capacitance $V_{GS}=0\text{V}, V_{DS}=15\text{V}, f=1.0\text{MHz}$	$C_{rss}$	-	111	-	

## Switching

Turn-on Delay Time <sup>2</sup> $V_{DS}=15V, V_{GS}=10V, I_D=1A, R_D=15\Omega, R_G=2\Omega$	$t_d(\text{on})$	-	6	-	ns
Rise Time $V_{DS}=15V, V_{GS}=10V, I_D=1A, R_D=15\Omega, R_G=2\Omega$	$t_r$	-	14	-	
Turn-off Delay Time $V_{DS}=15V, V_{GS}=10V, I_D=1A, R_D=15\Omega, R_G=2\Omega$	$t_d(\text{off})$	-	18.4	-	
Fall Time $V_{DS}=15V, V_{GS}=10V, I_D=1A, R_D=15\Omega, R_G=2\Omega$	$t_f$	-	2.8	-	
Total Gate Charge <sup>2</sup> $V_{DS}=10V, V_{GS}=4.5V, I_D=5.3A$	$Q_g$	-	8.7	-	nC
Gate-Source Charge $V_{DS}=10V, V_{GS}=4.5V, I_D=5.3A$	$Q_{gs}$	-	1.5	-	
Gate-Drain Change $V_{DS}=10V, V_{GS}=4.5V, I_D=5.3A$	$Q_{gd}$	-	3.6	-	

## Source-Drain Diode Characteristics

Forward On Voltage <sup>2</sup> $V_{GS}=0, I_S=1.2A, T_J=25^\circ\text{C}$	$V_{SD}$	-	-	1.2	V
Reverse Recovery Time $V_{GS}=0, I_S=5A, dl/dt=100A/\mu s$	$T_{rr}$	-	16.8	-	nS
Reverse Recovery Charge $V_{GS}=0, I_S=5A, dl/dt=100A/\mu s$	$Q_{rr}$	-	11	-	nC

- Note: 1. Pulse width limited by Max, junction temperature.  
 2. pulse width  $\leq 300\mu s$ , duty cycle  $\leq 2\%$ .  
 3. Surface mounted on 1 in<sup>2</sup> copper pad of FR4 board; 270°C/W when mounted on min, copper pad.

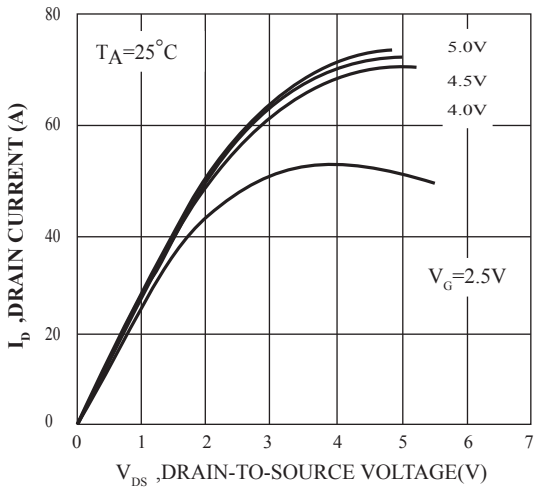

**FIG.1 Typical Output Characteristics**

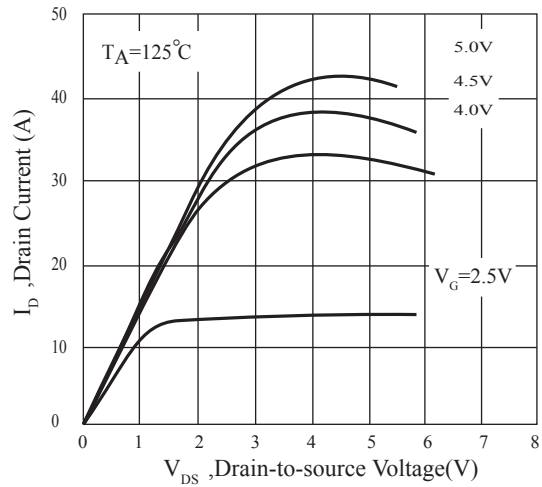

**Fig.2 Typical Output Characteristics**

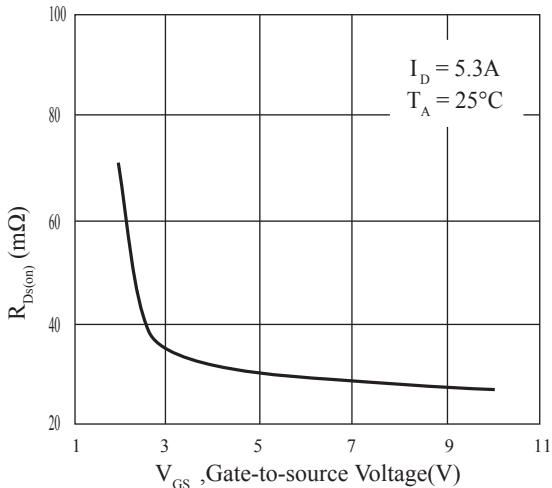

**Fig.3 On-Resistance v.s. Gate Voltage**

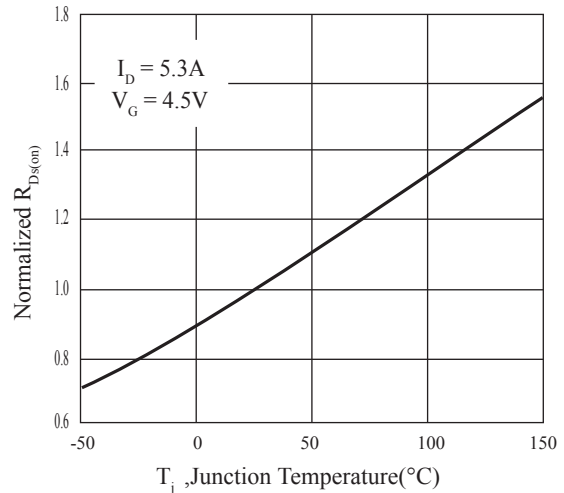

**Fig.4 Normalized OnResistance**

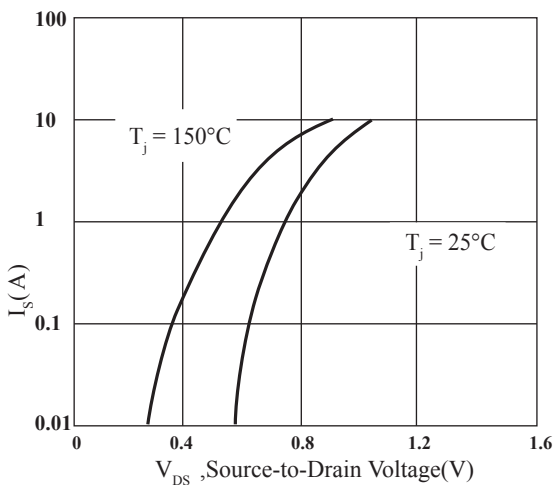

**Fig.5 Forward Characteristics of Reverse Diode**

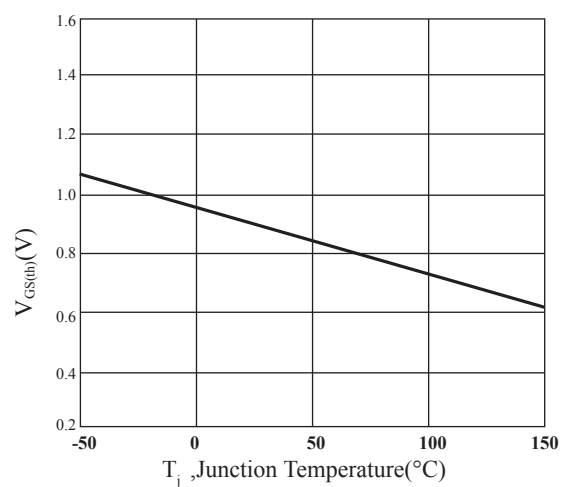

**Fig.6 Gate Threshold Voltage v.s. Junction Temperature**

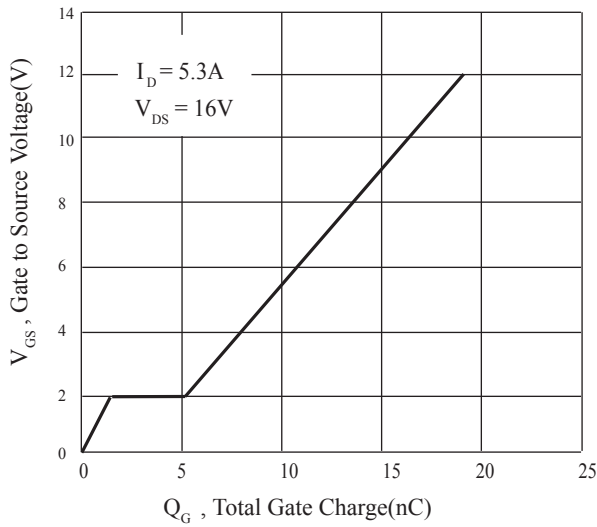

**Fig 7. Gate Charge Characteristics**

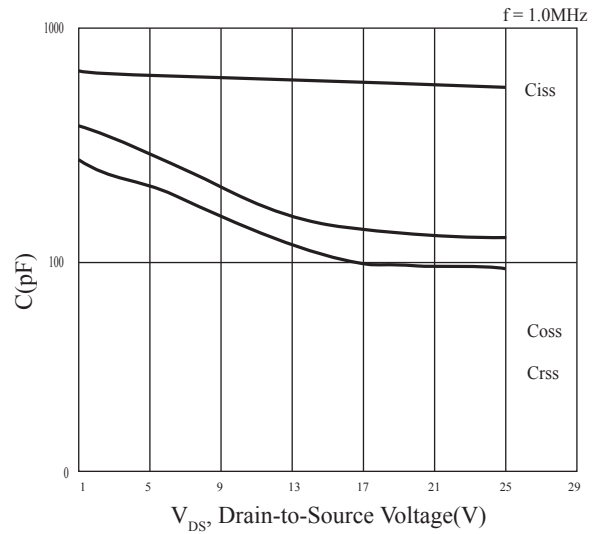

**Fig 8. Typical Capacitance Characteristics**

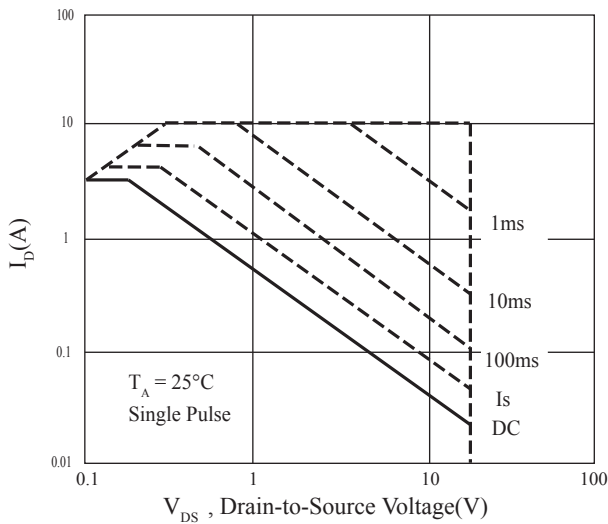

**Fig 9. Maximum Safe Operation Area**

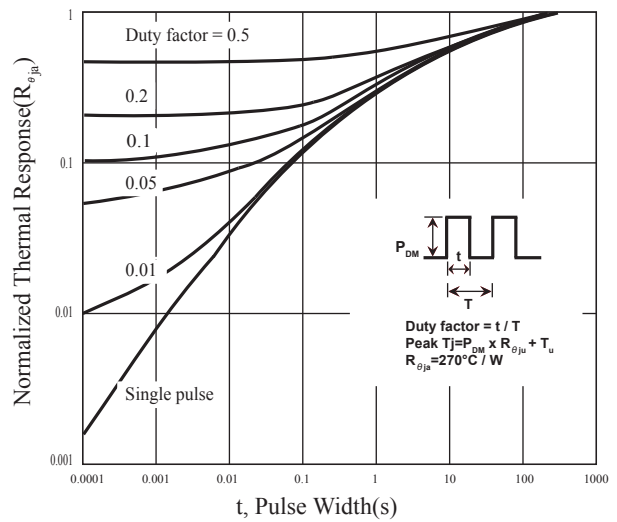

**Fig 10. Effective Transient Thermal Impedance**

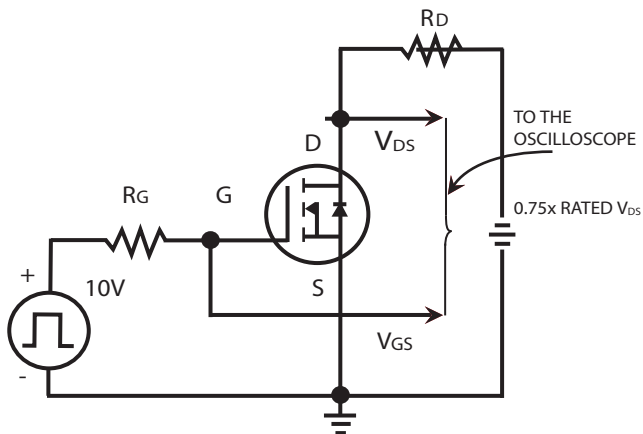

**Fig 11. Switching Time Circuit**

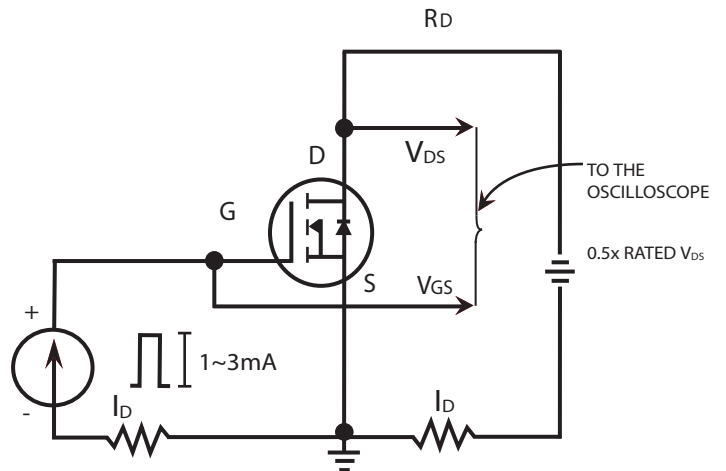

**Fig 12. Gate Charge Circuit**

### SOT-23 Outline Dimension

