

Surface Mount N-Channel Enhancement Mode MOSFET

 **Lead(Pb)-Free**

Features:

*Super high dense cell design for low $R_{DS(ON)}$

$R_{DS(ON)} < 30 \text{ m}\Omega @ V_{GS} = 10\text{V}$

$R_{DS(ON)} < 42 \text{ m}\Omega @ V_{GS} = 4.5\text{V}$

*Rugged and Reliable

*SOT-23 Package

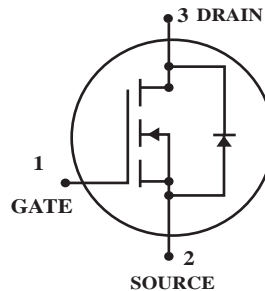

DRAIN CURRENT
4.6 AMPERES
DRAIN SOURCE VOLTAGE
30 VOLTAGE

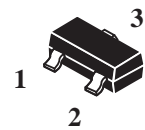

SOT-23

Maximum Ratings (TA=25°C Unless Otherwise Specified)

Rating	Symbol	Value	Unite
Drain-Source Voltage	V_{DS}	30	V
Gate-Source Voltage	V_{GS}	± 20	V
Continuous Drain Current ($T_J = 125^\circ\text{C}$) ⁽¹⁾	I_D	4.6	A
Pulsed Drain Current ⁽²⁾	I_{DM}	16	A
Drain-Source Diode Forward Current (1)	I_S	1.25	A
Power Dissipation (1)	P_D	1.25	W
Maximax Junction-to-Ambient	$R_{\theta JA}$	100	$^\circ\text{C/W}$
Operating Junction and Storage Temperature Range	T_J, T_{stg}	-55 to 150	$^\circ\text{C}$

Device Marking

WT3402=T02

Electrical Characteristics (T_A=25 °C Unless otherwise noted)

Characteristic	Symbol	Min	Typ	Max	Unit
----------------	--------	-----	-----	-----	------

Static (2)

Drain-Source Breakdown Voltage V _{GS} =0V, I _D =250 uA	V _{(BR)DSS}	30	-	-	V
Gate-Source Threshold Voltage V _{DS} =V _{GS} , I _D =250 uA	V _{GS(th)}	1	1.5	2.5	V
Gate-Source Leakage Current V _{DS} =0V, V _{GS} =±20V	I _{GSS}	-	-	±100	nA
Zero Gate Voltage Drain Current V _{DS} =24V, V _{GS} =0V	I _{DSS}	-	-	1	uA
Drain-Source On-Resistance V _{GS} =10V, I _D =4.6A V _{GS} =4.5V, I _D =4.0A	r _{DS(on)}	- -	26 38	30 42	mΩ
On-State Drain Current V _{DS} =5V, V _{GS} =4.5A	I _{D(on)}	10	-	-	A
Forward Transconductance V _{DS} =5V, I _D =4.6A	g _{fs}	-	5	-	S

Dynamic(3)

Input Capacitance V _{DS} =15V, V _{GS} =0V, f=1MHZ	C _{iss}	-	782	-	pF
Output Capacitance V _{DS} =15V, V _{GS} =0V, f=1MHZ	C _{oss}	-	135	-	
Reverse Transfer Capacitance V _{DS} =15V, V _{GS} =0V, f=1MHZ	C _{rss}	-	93	-	

Switching(3)

Turn-On Delay Time V _{GS} = 10V, V _{DD} =15V, I _D =1A, R _L =15 Ω, R _{GEN} =6Ω	t _{d(on)}	-	4.8	-	nS
Rise Time V _{GS} = 10V, V _{DD} =15V, I _D =1A, R _L =15 Ω, R _{GEN} =6Ω	t _r	-	3.9	-	nS
Turn-Off Delay Time V _{GS} = 10V, V _{DD} =15V, I _D =1A, R _L =15 Ω, R _{GEN} =6Ω	t _{d(off)}	-	27.7	-	nS
Fall Time V _{GS} = 10V, V _{DD} =15V, I _D =1A, R _L =15 Ω, R _{GEN} =6Ω	t _f	-	5.5	-	nS
Total Gate Charge V _{DS} =15V, I _D =4.6A, V _{GS} =10V	Q _g	-	15.8	-	nc
Gate-Source Charge V _{DS} =15V, I _D =4.6A, V _{GS} =10V	Q _{gs}	-	2	-	nc
Gate-Drain Charge V _{DS} =15V, I _D =4.6A, V _{GS} =10V	Q _{gd}	-	3	-	nc
Drain-Source Diode Forward Voltage V _{GS} =0V, I _S =1.25A	V _{SD}	-	0.78	1.2	V

- Note: 1. Surface Mounted on FR4 Board t ≤ 10sec.
 2. Pulse Test : PW ≤ 300us, Duty Cycle ≤ 2%.
 3. Guaranteed by Design, not Subject to Production Testing.

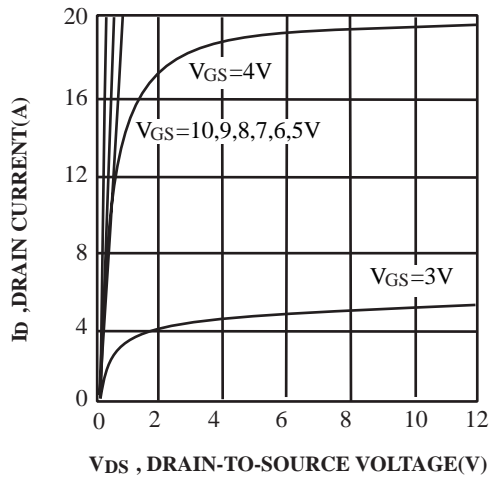

FIG.1. Output Characteristics

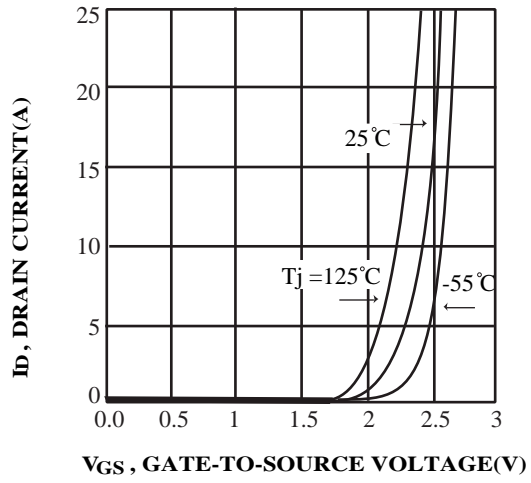

FIG.2 Transfer Characteristics

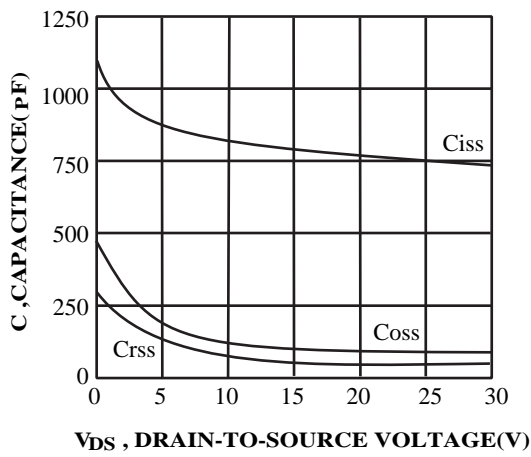

FIG.3 Capacitance

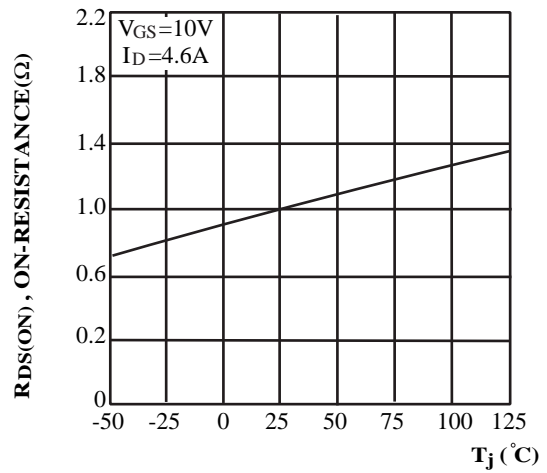

FIG.4 On-Resistance Variation with Temperature

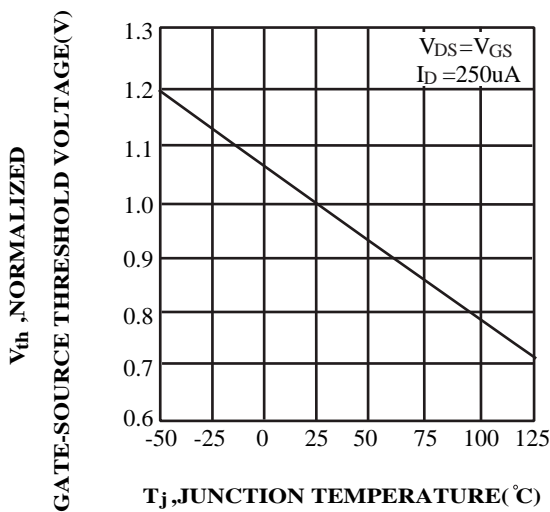

FIG.5 Gate Threshold Variation with Temperature

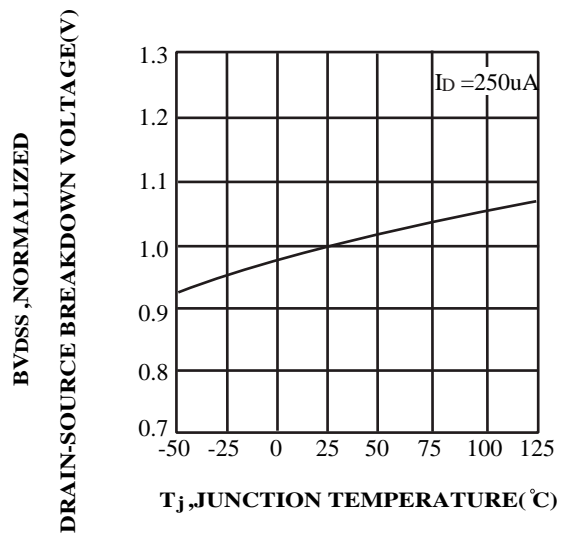
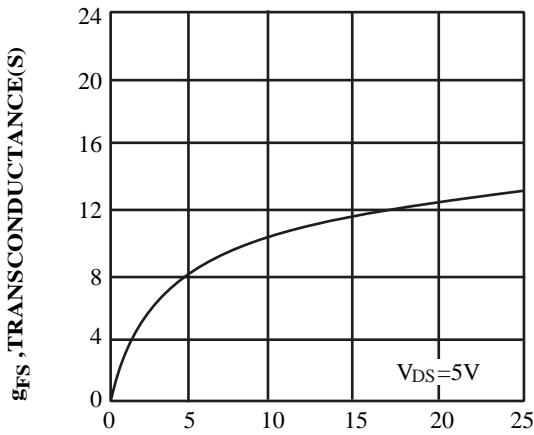
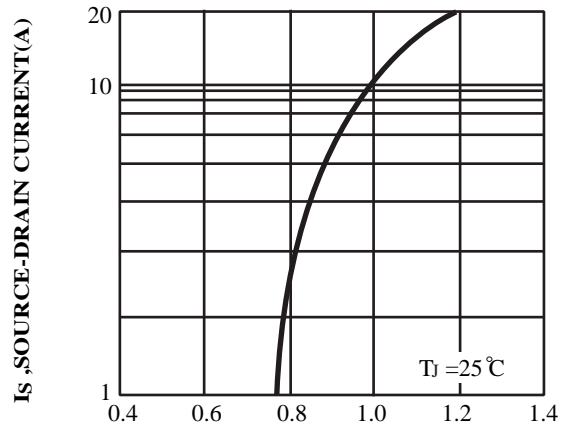

FIG.6 Breakdown Voltage Variation with Temperature



IDS ,DRAIN-SOURCE CURRENT(A)
FIG.7 Transconductance Variation with Drain Current



VSD ,BODY DIODE FORWARD VOLTAGE(V)
FIG.8 Body Diode Forward Voltage Variation with Source Current

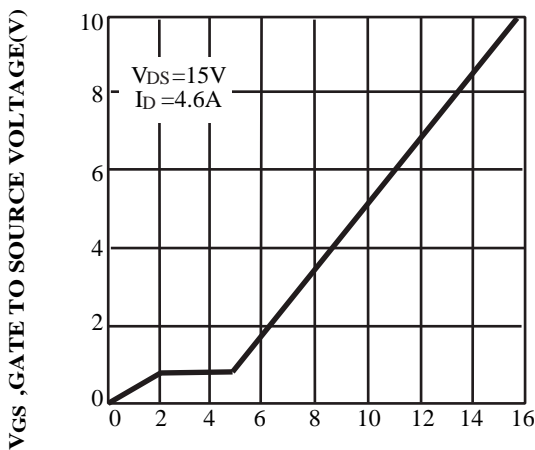

Qg ,TOTAL GATE CHARGE(nC)
FIG.9 Gate Charge

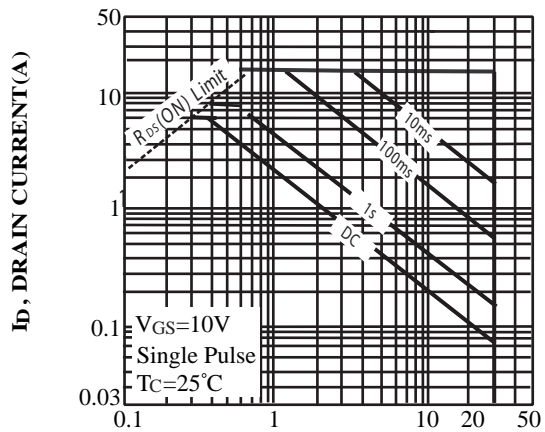

Vds ,DRAIN-SOURCE VOLTAGE(V)
FIG.10 Maximum Safe Operating Area

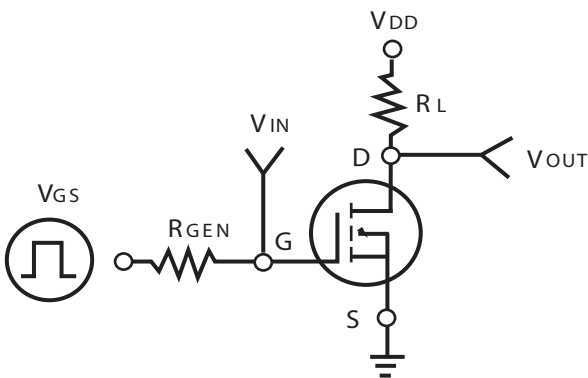

FIG.11 Switching Test Circuit

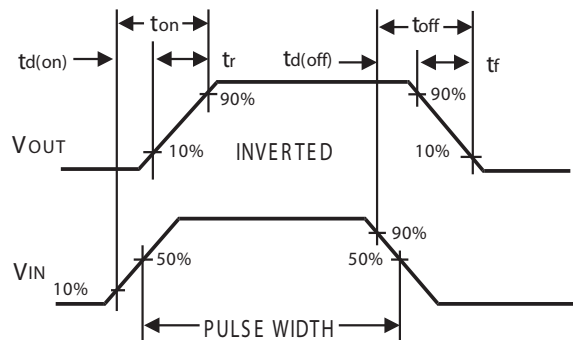

FIG.12 Switching Waveforms

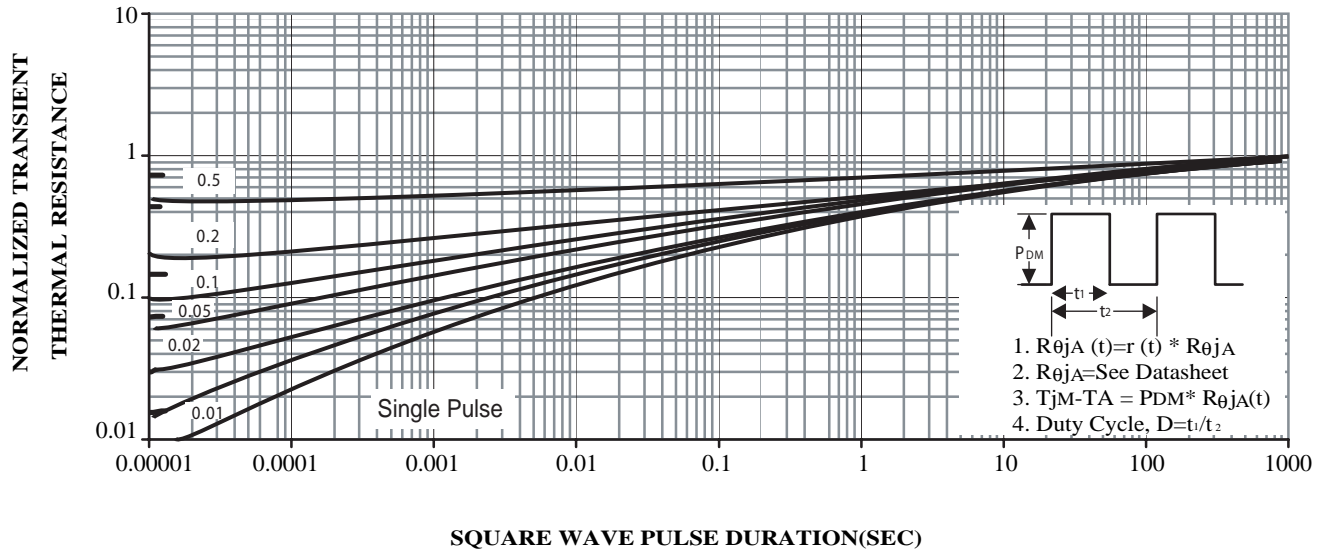
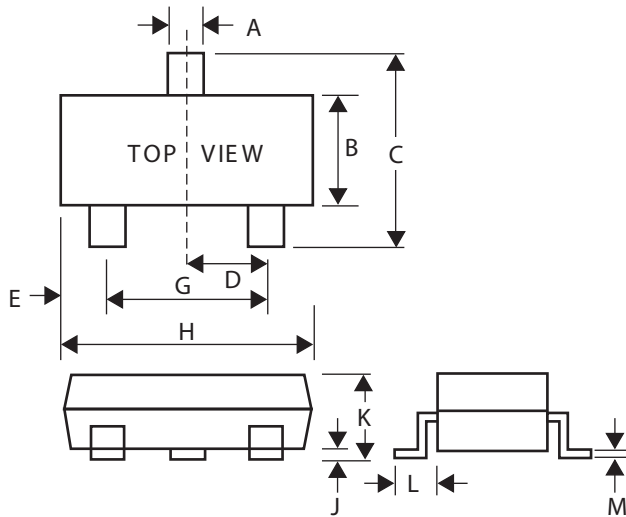

FIG.13 NORMALIZED THERMAL TRANSIENT IMPEDANCE CUREVE

SOT-23 Package Outline Dimensions

Unit:mm



Dim	Min	Max
A	0.35	0.51
B	1.19	1.40
C	2.10	3.00
D	0.85	1.05
E	0.46	1.00
G	1.70	2.10
H	2.70	3.10
J	0.01	0.13
K	0.89	1.10
L	0.30	0.61
M	0.076	0.25