

High Voltage Transistor

NPN Silicon

MMBT5551

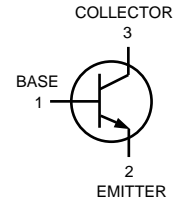
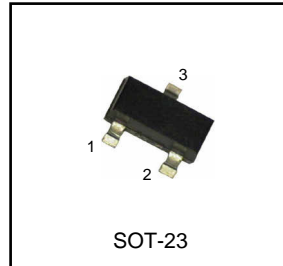

MAXIMUM RATINGS

Rating	Symbol	Value	Unit
Collector-Emitter Voltage	V _{CEO}	140	V _{dc}
Collector-Base Voltage	V _{CBO}	160	V _{dc}
Emitter-Base Voltage	V _{EBO}	6.0	V _{dc}
Collector Current-Continuous	I _C	600	mAdc

THERMAL CHARACTERISTICS

Characteristic	Symbol	Max.	Unit
Total Device Dissipation FR-5 Board ⁽¹⁾ T _A =25°C Derate above 25°C	P _D	225 1.8	mW mW / °C
Thermal Resistance Junction to Ambient	R _{θJA}	556	°C / W
Total Device Dissipation Alumina Substrate, ⁽²⁾ T _A =25°C Derate above 25°C	P _D	300 2.4	mW mW / °C
Thermal Resistance Junction to Ambient	R _{θJA}	417	°C / W
Junction and Storage Temperature	T _J ,T _{STG}	-55 to +150	°C

DEVICE MARKING

MMBT5551=G1

ELECTRICAL CHARACTERISTICS (T_A=25°C unless otherwise noted)

Characteristic	Symbol	Min.	Max.	Unit
----------------	--------	------	------	------

OFF CHARACTERISTICS

Collector-Emitter Breakdowe Voltage ⁽³⁾ (I _C =1.0mAdc, I _B =0)	V _{(BR)CEO}	160	-	V _{dc}
Collector-Base Breakdowe Voltage (I _C =100 uAdc, I _E =0)	V _{(BR)CBO}	180	-	V _{dc}
Emitter-Base Breakdowe Voltage (I _E =10 uAdc, I _C =0)	V _{(BR)EBO}	6.0	-	V _{dc}
Base Cutoff Current (V _{CE} =120 Vdc, I _E =0) (V _{CE} =120 Vdc, I _E =0, T _A = 100°C)	I _{CBO}	-	50 50	nAdc uAdc
Collector Cutoff Current (V _{EB} =4.0 Vdc, I _C =0)	I _{EBO}	-	50	nAdc

(1) FR-5=1.0 x 0.75 x 0.062in.

(2) Alumina=0.4 x 0.3 x 0.024in. 99.5% alumina.

(3) Pulse Test : Pulse Width = 300 uS, Duty Cycle = 2.0%.

ELECTRICAL CHARACTERISTICS ($T_A=25^{\circ}\text{C}$ unless otherwise noted) (Continued)

Characteristic	Symbol	Min.	Max.	Unit
----------------	--------	------	------	------

ON CHARACTERISTICS

DC Current Gain ($I_C= 1.0 \text{ mAdc}$, $V_{CE}= 5.0 \text{ Vdc}$) ($I_C= 10 \text{ mAdc}$, $V_{CE}= 5.0 \text{ Vdc}$) ($I_C= 50 \text{ mAdc}$, $V_{CE}= 5.0 \text{ Vdc}$)	HFE	80 80 30	- 250 -	-
Collector-Emitter Saturation Voltage ($I_C= 10 \text{ mAdc}$, $I_B= 1.0 \text{ mAdc}$) ($I_C= 50 \text{ mAdc}$, $I_B= 5.0 \text{ mAdc}$)	$V_{CE}(\text{sat})$	- -	0.15 0.20	Vdc
Base-Emitter Saturation Voltage ($I_C= 10 \text{ mAdc}$, $I_B= 1.0 \text{ mAdc}$) ($I_C= 50 \text{ mAdc}$, $I_B= 5.0 \text{ mAdc}$)	$V_{BE}(\text{sat})$	- -	1.0 1.0	Vdc

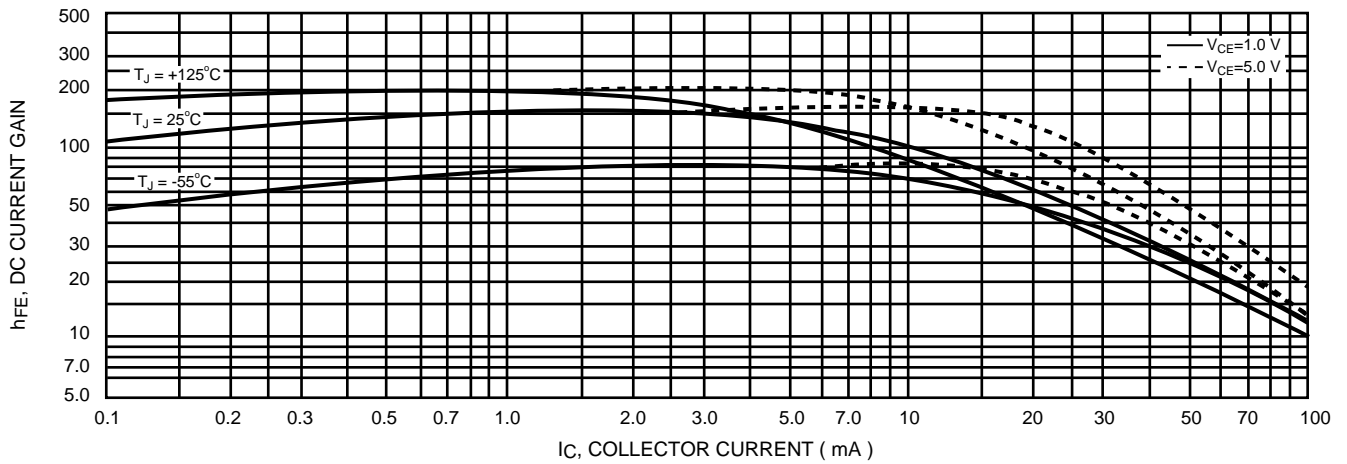

Figure 1. DC Current Gain

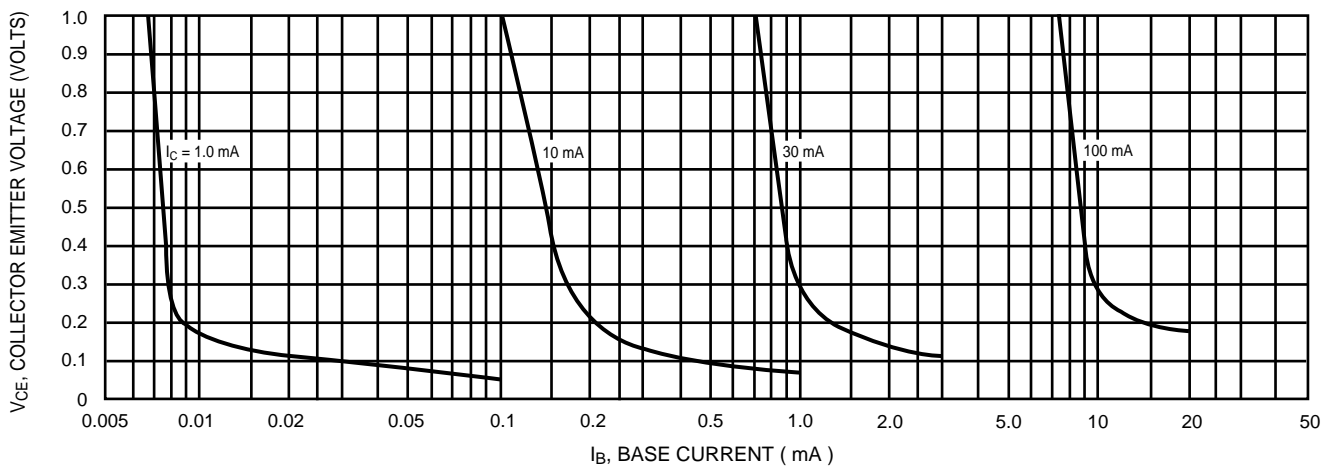

Figure 2. Collector Saturation Region

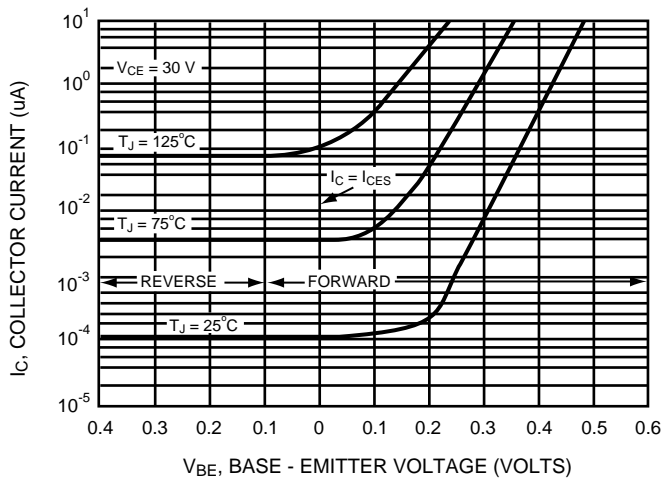

Figure 3. Collector Cut - Off Region

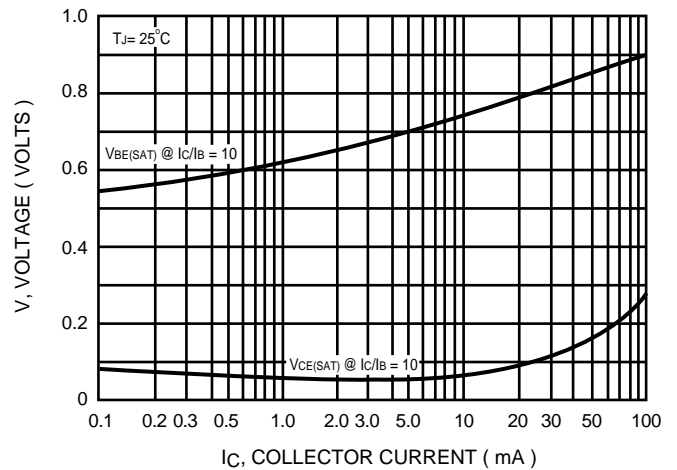

Figure 4. " On " Voltages

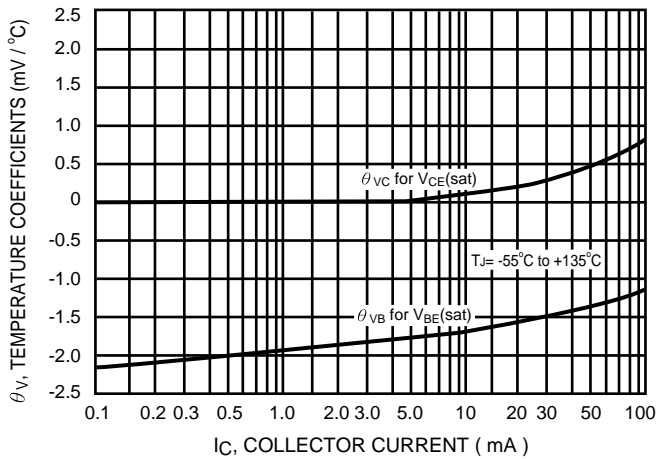
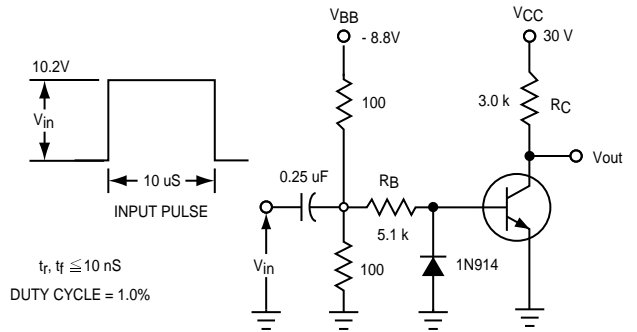

Figure 5. Temperature Coefficients



VALUES SHOWN ARE FOR IC @ 10 mA
Figure 6. Switching Time Test Circuit

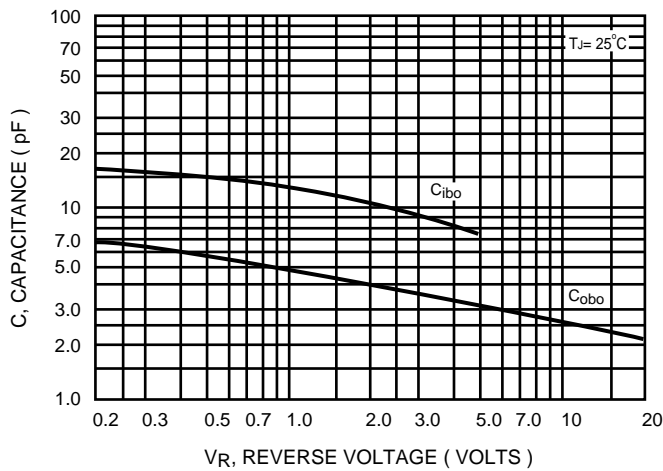

Figure 7. Capacitances

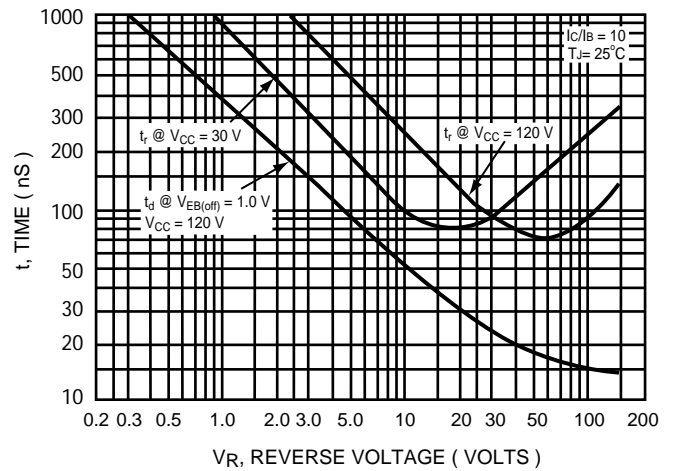

Figure 8. Turn-On Time

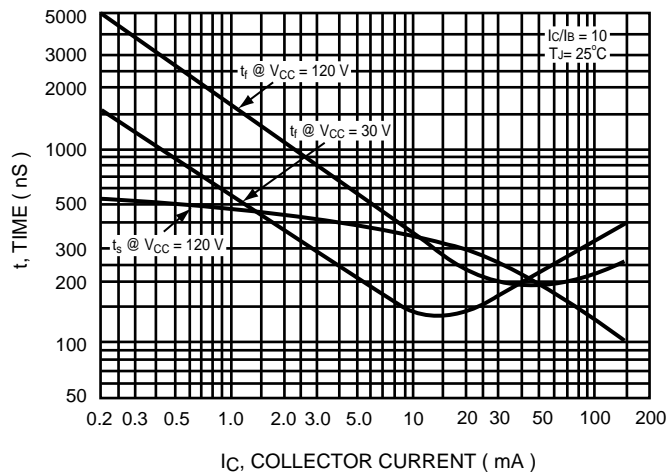

Figure 9. Turn - Off Time