

**VERY LOW VOLTAGE AM-FM RADIO**

- OPERATING SUPPLY VOLTAGE : 1.5 TO 6V
- HIGH SENSITIVITY AND LOW NOISE
- LOW BATTERY DRAIN
- VERY LOW TWEET
- HIGH SIGNAL HANDLING
- VERY SIMPLE DC SWITCHING OF AM-FM
- AM SECTION OPERATES UP TO 30MHz

**DESCRIPTION**

The TDA 7220 is a monolithic integrated circuit in a 16-lead dual in-line plastic package designed for use in 3V, 4.5V and 6V portable AM-FM radio receivers.

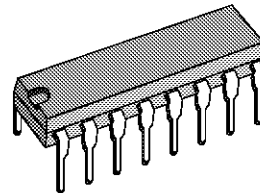
The functions incorporated are :

**AM Section**

- Pre-amplifier and double balanced mixer with AGC
- On pin local oscillator
- IF amplifier with internal AGC
- Detector and audio preamplifier

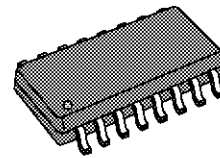
**FM SECTION**

- IF amplifier and limiter
- Quadrature detector
- Audio preamplifier



DIP16

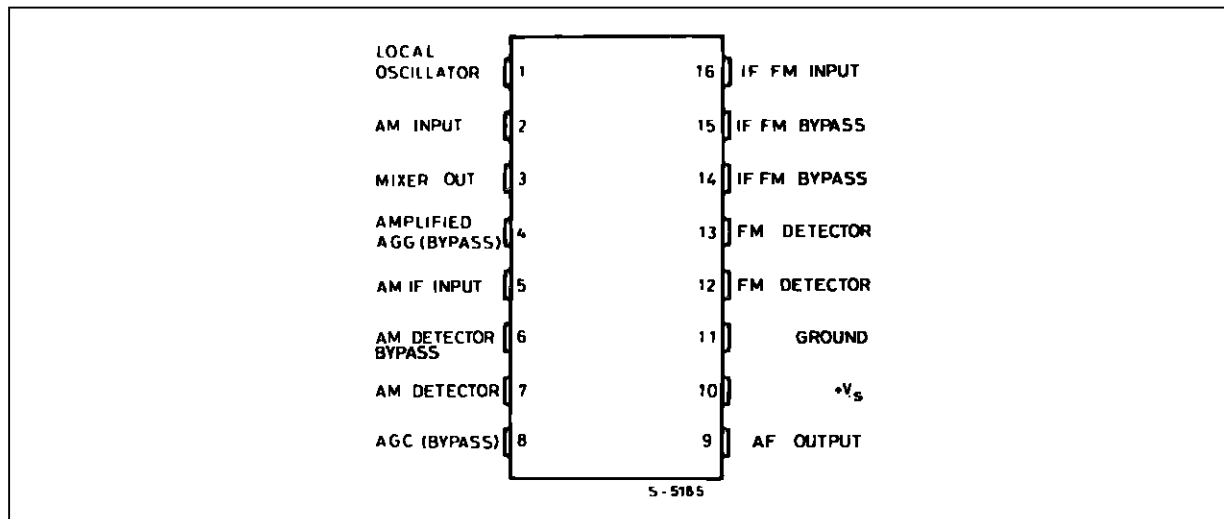
ORDERING NUMBER : TDA7220



SO16

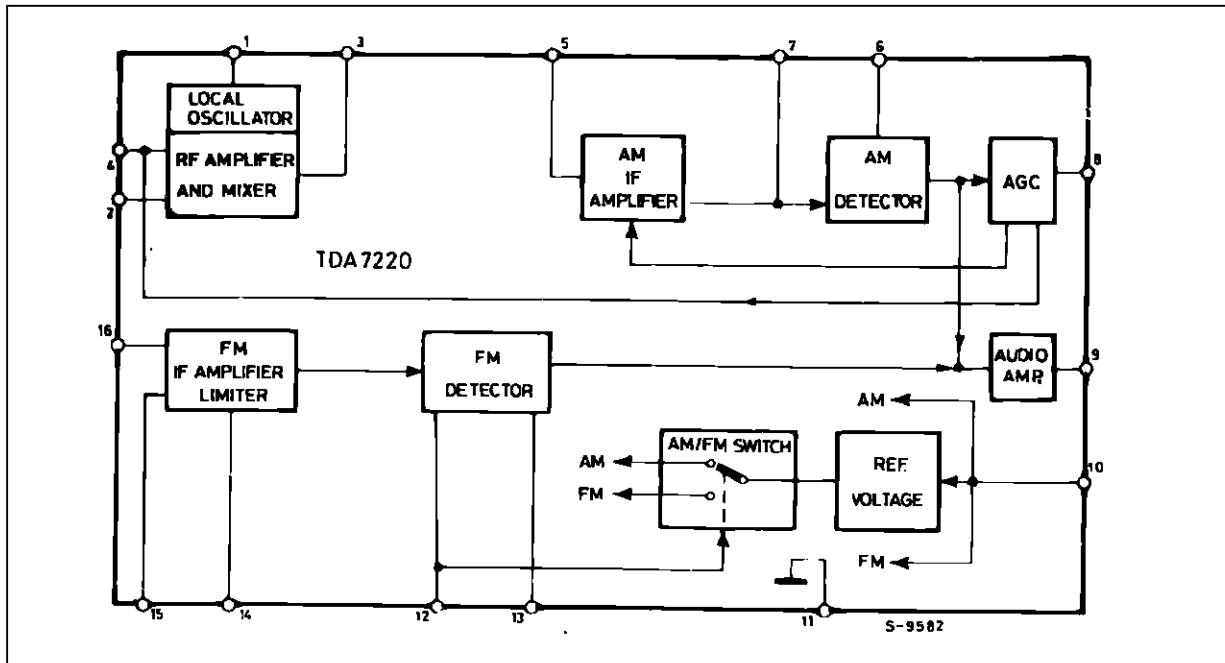
ORDERING NUMBER : TDA7220D

**PIN CONNECTION**



# TDA7220

## BLOCK DIAGRAM



## ABSOLUTE MAXIMUM RATINGS

Symbol	Parameter	Value	Unit
$V_s$	Supply Voltage	6.5	V
$P_{tot}$	Total Power Dissipation at $T_{amb} < 110^{\circ}\text{C}$ (DIP16)	400	mW
$T_{oper}$	Operating Temperature	- 20 to + 85	$^{\circ}\text{C}$
$T_{stg}, T_j$	Storage and Junction Temperature	- 55 to +150	$^{\circ}\text{C}$

## THERMAL DATA

Symbol	Parameter	DIP16	SO16	Unit
$R_{th(j-a)}$	Junction-ambient Thermal Resistance	Max. 100	200	$^{\circ}\text{C/W}$

**ELECTRICAL CHARACTERISTICS** ( $T_{amb} = 25^{\circ}\text{C}$ ,  $V_s = 3\text{V}$ , unless specified, refer to Test Circuit)

Symbol	Parameter	Test Conditions	Min.	Typ.	Max.	Unit
$I_D$	Drain Current	AM Section		11	18	mA
		FM Section		10	15	mA

AM SECTION ( $f_o = 1\text{MHz}$ ,  $f_m = 1\text{kHz}$ )

$V_I$	Input Sensitivity	S/N = 26dB, $m = 0.3$		12	25	$\mu\text{V}$
S/N	Signal to Noise	$V_I = 1\text{mV}$ , $m = 0.3$	40	50		dB
$\Delta V_I$	AGC Range	$\Delta V_{OUT} = 10\text{dB}$ , $m = 0.8$	90			dB
$V_O$	Recovered Audio Signal (Pin 9)	$V_I = 1\text{mV}$ , $m = 0.3$	40	80	110	mV
d	Distortion			0.6		%
$V_H$	Max. Input Signal Handling Capability	$m = 0.8$ , $d < 10\%$	0.5			V
$R_I$	Input Resistance between Pins 2 and 4	$m = 0$		7.5		$\text{k}\Omega$
$C_I$	Input Capacitance between Pins 2 and 4	$m = 0$		18		pF
$R_O$	Output Resistance (Pin 9)			4.5		$\text{k}\Omega$
	Tweet 2 IF	$V_I = 1\text{mV}$ , $m = 0.3$		40		dB
	Tweet 3 IF	$V_I = 1\text{mV}$ , $m = 0.3$		55		dB

FM SECTION ( $f_o = 10.7\text{MHz}$ ,  $f_m = 1\text{kHz}$ )

$V_I$	Input Limiting Voltage	- 3dB limiting point		33	80	$\mu\text{V}$
AMR	Amplitude Modulation Rejection	$\Delta f = \pm 22.5\text{kHz}$ , $V_I = 3\text{mV}$ , $m = 3$		40		dB
S/N	Signal to Noise	$\Delta f = \pm 22.5\text{kHz}$ , $V_I = 1\text{mV}$	50	65		dB
d	Distortion	$\Delta f = \pm 22.5\text{kHz}$ , $V_I = 1\text{mV}$ $\Delta f = \pm 75\text{kHz}$		0.3		%
				1.1	1.5	%
$V_O$	Recovered Audio Signal (Pin 9)	$\Delta f = \pm 22.5\text{kHz}$ , $V_I = 1\text{mV}$	40	70	90	mV
$R_I$	Input Resistance between Pin 16 and Ground			6.5		$\text{k}\Omega$
$C_I$	Input Capacitance between Pin 16 and Ground			14		pF
$R_O$	Output Resistance (Pin 9)			4.5		$\text{k}\Omega$

## TDA7220

### ELECTRICAL CHARACTERISTICS ( $T_{amb} = 25^{\circ}\text{C}$ , $V_s = 1.6\text{V}$ , unless specified, refer to Test Circuit)

Symbol	Parameter	Test Conditions	Min.	Typ.	Max.	Unit
$I_D$	Drain Current	AM Section		8	15	mA
		FM Section		7	13	mA

#### AM SECTION ( $f_o = 1\text{MHz}$ , $f_m = 1\text{kHz}$ )

$V_I$	Input Sensitivity	S/N = 26dB, $m = 0.3$		15	25	$\mu\text{V}$
S/N	Signal to Noise	$V_I = 1\text{mV}$ , $m = 0.3$	40	48		dB
$\Delta V_I$	AGC Range	$\Delta V_{OUT} = 10\text{dB}$ , $m = 0.8$	90			dB
$V_O$	Recovered Audio Signal (Pin 9)	$V_I = 1\text{mV}$ , $m = 0.3$	40	75		mV
d	Distortion			0.5		
$V_H$	Max. Input Signal Handling Capability	$m = 0.8$ , $d < 10\%$	0.5			V
$R_I$	Input Resistance between Pins 2 and 4	$m = 0$		7.5		$\text{k}\Omega$
$C_I$	Input Capacitance between Pins 2 and 4	$m = 0$		18		pF
$R_O$	Output Resistance (Pin 9)			4.5		$\text{k}\Omega$
	Tweet 2 IF	$V_I = 1\text{mV}$ , $m = 0.3$		40		dB
	Tweet 3 IF			55		dB

#### FM SECTION ( $f_o = 10.7\text{MHz}$ , $f_m = 1\text{kHz}$ )

$V_I$	Input Limiting Voltage	- 3dB limiting point		50		$\mu\text{V}$
AMR	Amplitude Modulation Rejection	$\Delta f = \pm 22.5\text{kHz}$ , $V_I = 3\text{mV}$ , $m = 3$		34		dB
S/N	Signal to Noise	$\Delta f = \pm 22.5\text{kHz}$ , $V_I = 1\text{mV}$		55		dB
d	Distortion	$\Delta f = \pm 22.5\text{kHz}$ , $V_I = 1\text{mV}$		0.6		%
$V_O$	Recovered Audio Signal (Pin 9)	$\Delta f = \pm 22.5\text{kHz}$ , $V_I = 1\text{mV}$		55		mV
$R_I$	Input Resistance between Pin 16 and Ground			6.5		$\text{k}\Omega$
$C_I$	Input Capacitance between Pin 16 and Ground			14		pF
$R_O$	Output Resistance (Pin 9)			4.5		$\text{k}\Omega$

Figure 1 : Test Circuit

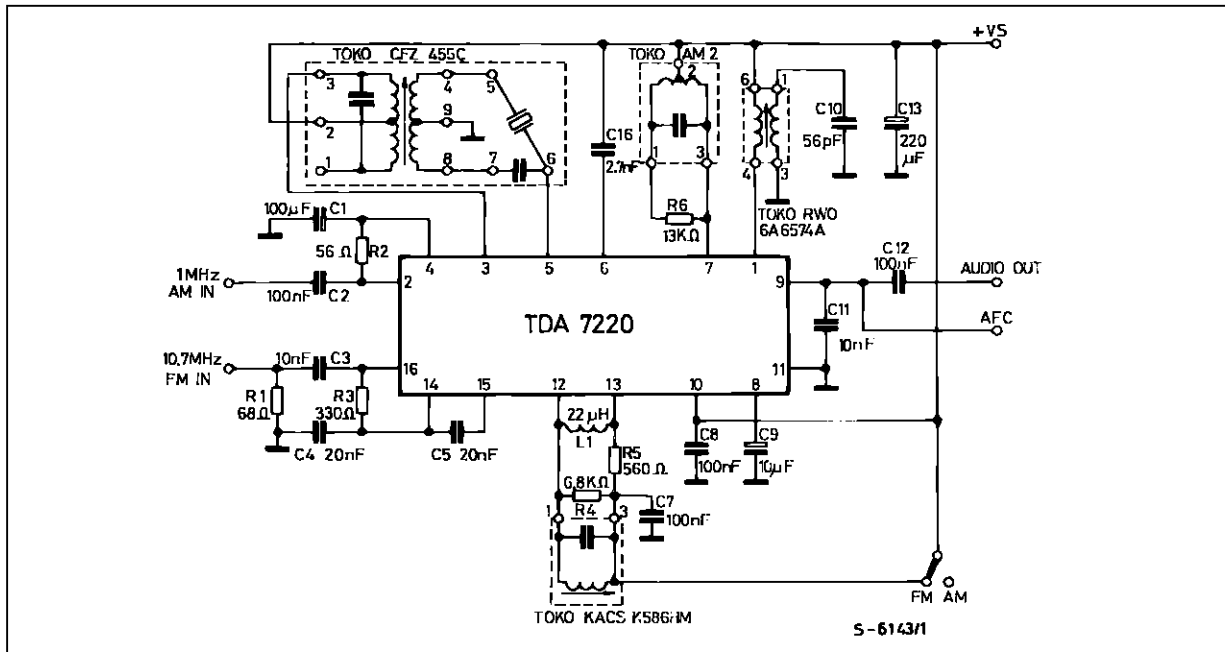
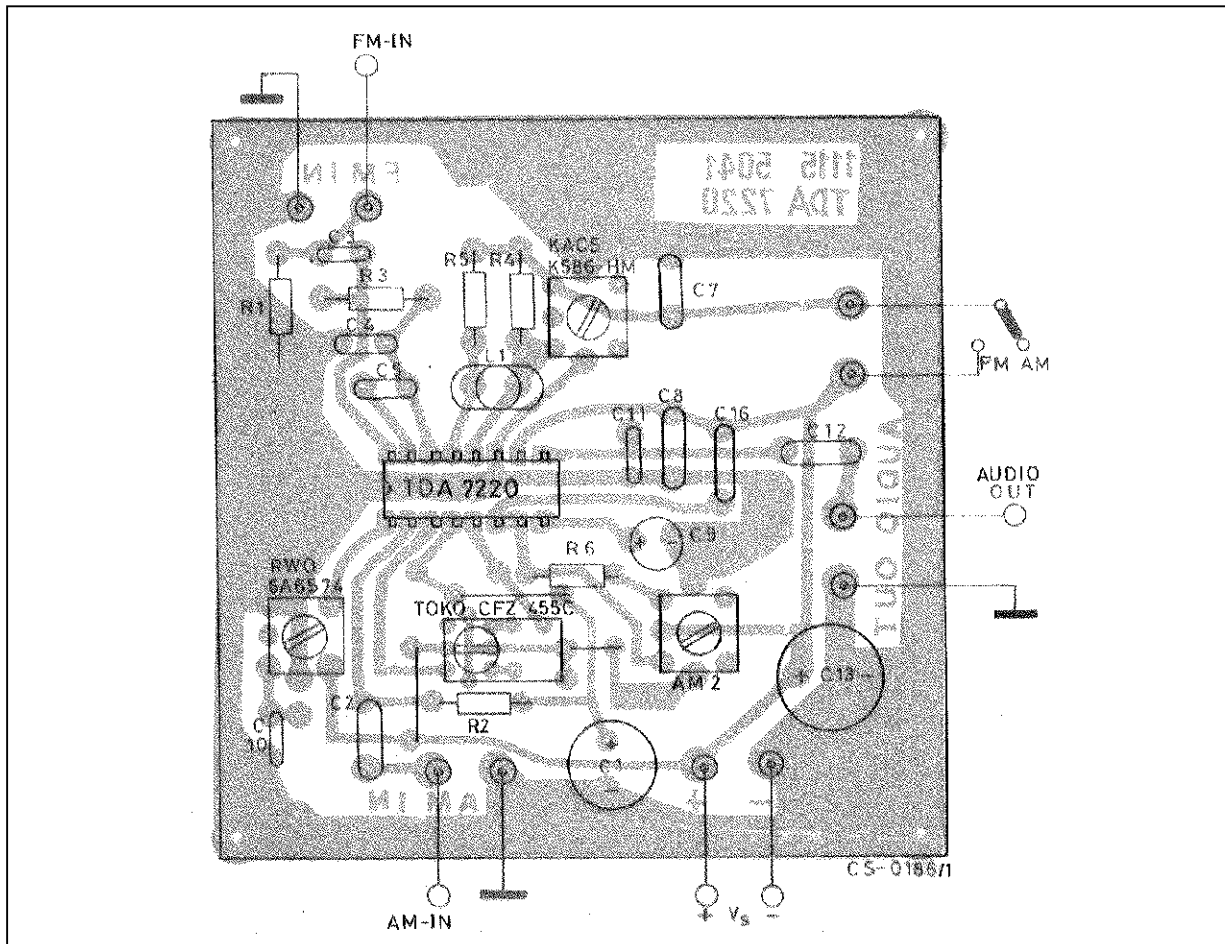


Figure 2 : P.C. Board and Component Layout (1:1 scale) of the Test Circuit



## TDA7220

### AM-FM SWITCHING

AM-FM switching is achieved by applying a DC voltage at pin 13, to switch the internal reference.

TYPICAL DC VOLTAGE (refer to the test circuit)

Pins	1	2	3	4	5	6	7	8	9	10	11	12	13	14	15	16	Unit
AM	3	1.1	3	1.1	1.1	2.5	3	0.7	1.2	3	0	2.1	2.1	2.9	3	2.9	V
FM	3	0	3	0	0	2.4	3	0	0.9	3	0	3	3	2.7	2.7	2.7	V

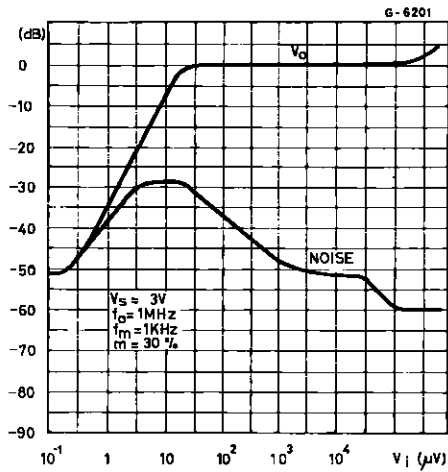
### APPLICATION SUGGESTION

Recommended values referred to the test circuit of Figure 1

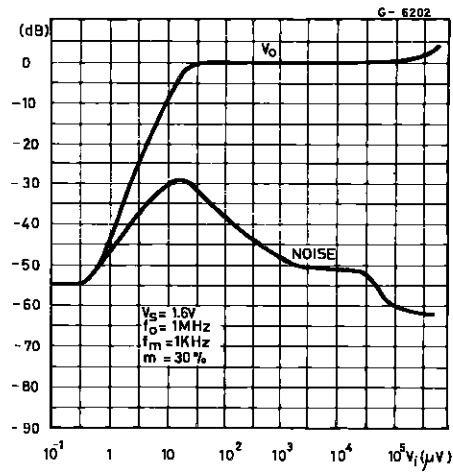
Part Number	Recommended Value	Purpose	Smaller than Recommended Value	Larger than Recommended Value
C1	100 $\mu$ F	AGC Bypass	Increase of the distortion at low audio frequency	Increase of the AGC time constant
C2 (1)	100nF	AM Input DC Cut		
C3 (1)	10nF	FM Input DC Cut		
C4 C5	20nF 20nF	FM Amplifier Bypass	Reduction of sensitivity	- bandwidth increase - higher noise
C7	100nF	FM detector Decoupling	Danger of RF Irradiation	
C8	100nF	Power Supply Bypass	Noise increase of the audio output	
C9	10 $\mu$ F	AGC Bypass	Increase of the distortion at low audio frequency	Increase of the AGC time constant
C10 (1)	56pF	Tuning of the AM Oscillator at 1455kHz		
C11	10nF	50ms FM De-emphasis		
C12	100nF	Output DC Decoupling	Low audio frequency cut	
C13	220 $\mu$ F	Power Supply Decoupling	Increase of the distortion at low frequency	
C16	2.7nF	AM Detector capacitor	Low suppression of the IF frequency and harmonics	Increase of the audion distortion
R1 (1)	68 $\Omega$	FM Input Matching		
R2 (1)	56 $\Omega$	AM Input Matching		
R3	330 $\Omega$	Ceramic Filter Matching		
R4	6.8k $\Omega$	FM Detector Coil Q Setting	Audio output decrease and lower distortion	Audio output increase and higher distortion
R5	560 $\Omega$	FM Detector Load Resistor	Audio output decrease and higher AMR	
R6	13k $\Omega$	AM Detector Coil Q Setting	Lower IF Gain and Lower AGC Range	Higher IF Gain and Lower AGC Range

(1) Only for test circuit.

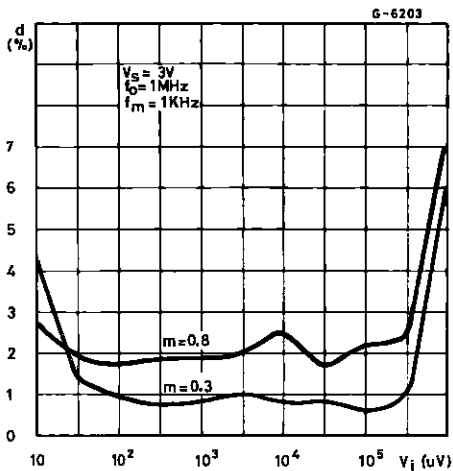
**Figure 3 :** Audio Output and Noise versus Input Signal (AM section)  $V_S = 3V$



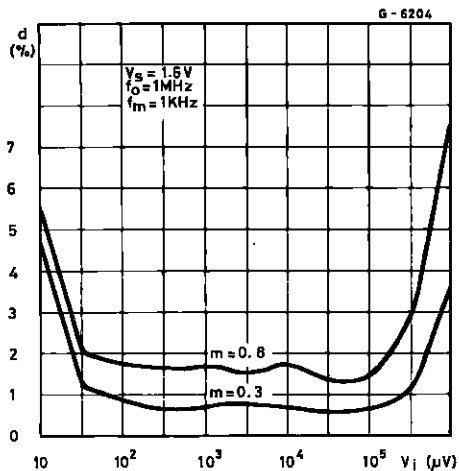
**Figure 4 :** Audio Output and Noise versus Input Signal (AM section)  $V_S = 1.6V$



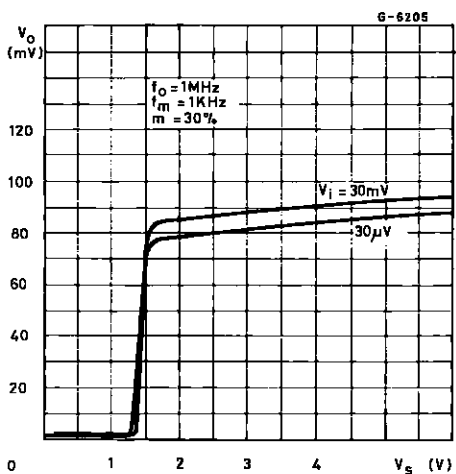
**Figure 5 :** Distortion versus Input Signal (AM section)  $V_S = 3V$



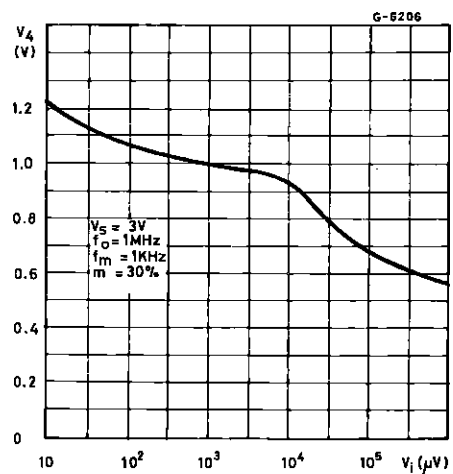
**Figure 6 :** Distortion versus Input Signal (AM section)  $V_S = 1.6V$



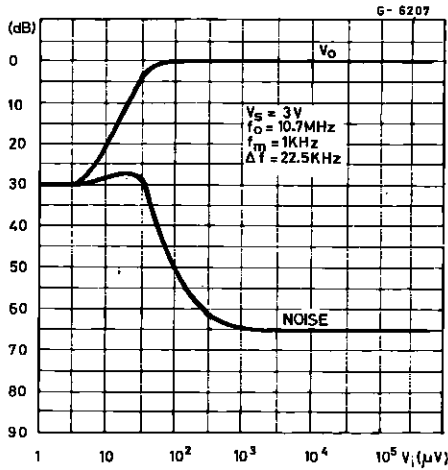
**Figure 7 :** Audio Output versus Supply Voltage (AM section)



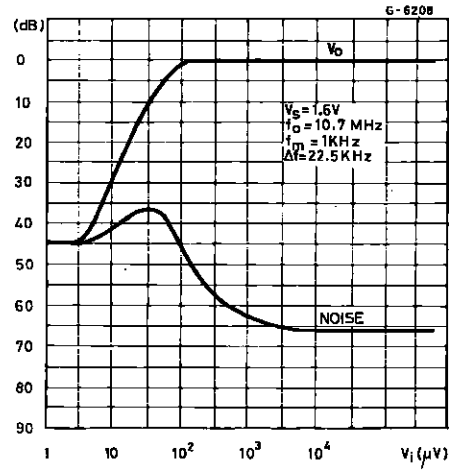
**Figure 8 :** Amplified AGC Voltage (Pin 4) versus Input Signal (AM section)



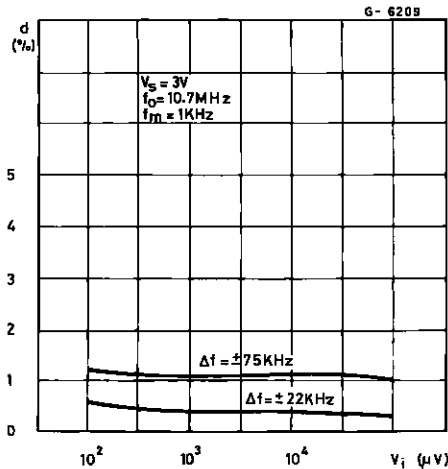
**Figure 9 :** Audio Output and Noise versus Input Signal (FM section)  $V_S = 3V$



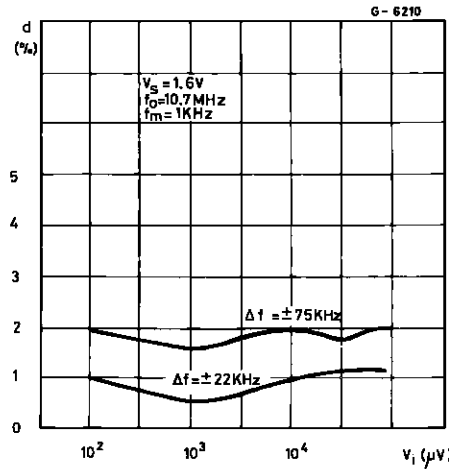
**Figure 10 :** Audio Output and Noise versus Input Signal (FM section)  $V_S = 1.6V$



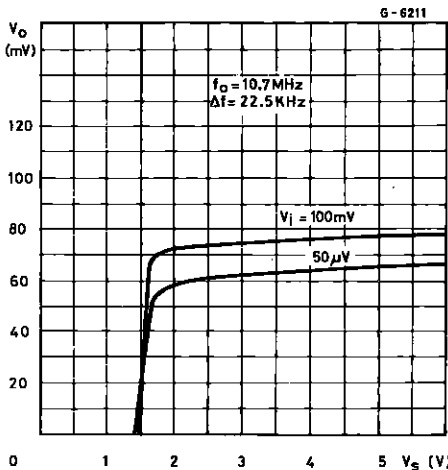
**Figure 11 :** Distortion versus Input Signal (FM section)  $V_S = 3V$



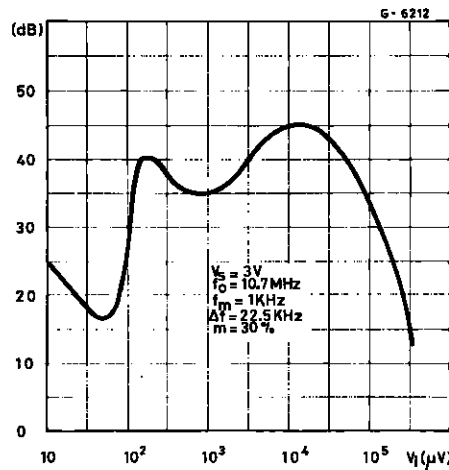
**Figure 12 :** Distortion versus Input Signal (FM section)  $V_S = 1.6V$



**Figure 13 :** Audio Output versus Supply Voltage (FM section)

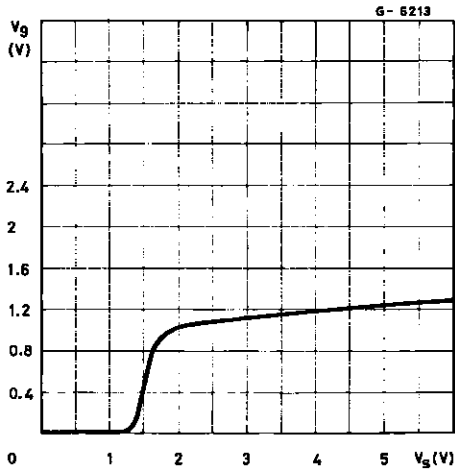


**Figure 14 :** Amplified AGC Voltage (Pin 4) versus Input Signal (FM section)

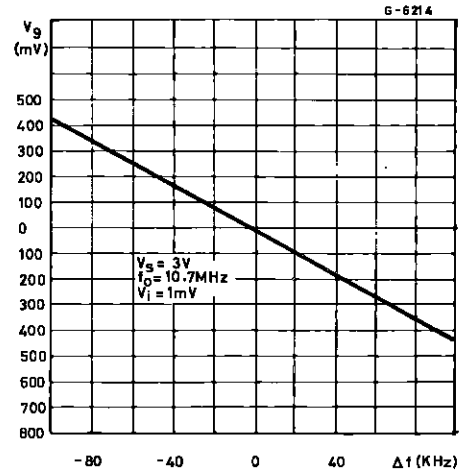




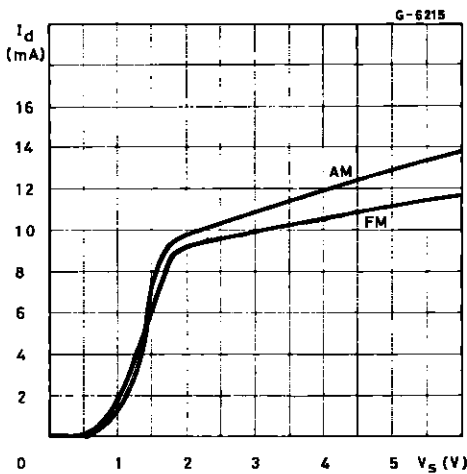
**Figure 15 :** DC Output Voltage (Pin 9) versus Supply Voltage (FM section)



**Figure 16 :** AFC Output Voltage (Pin 9) versus Frequency Deviation (FM section)



**Figure 17 :** Drain Current versus Supply Voltage



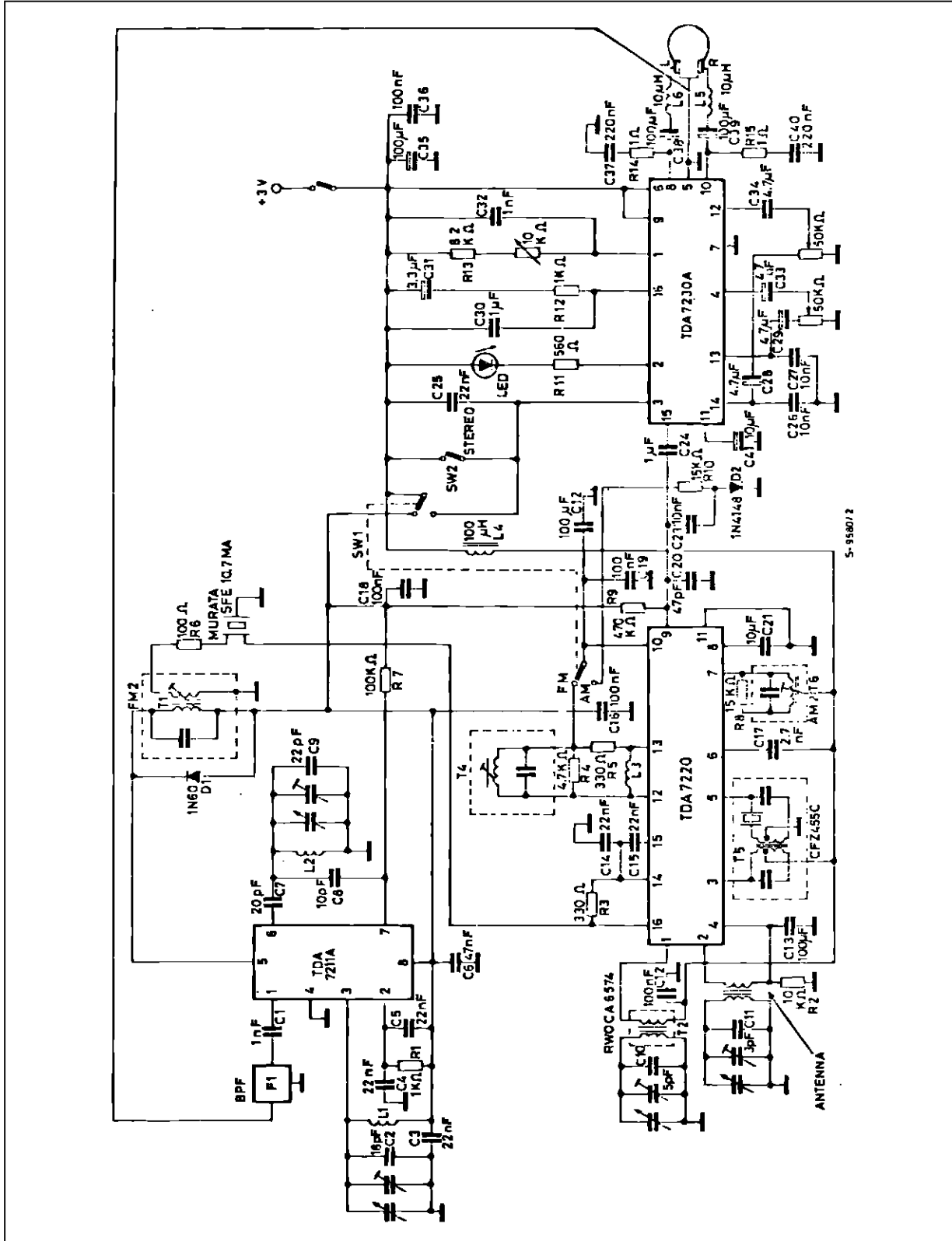
**APPLICATION INFORMATION**

TYPICAL PERFORMANCE OF THE RADIO RECEIVER OF FIGURE 18 ( $V_S = 3V$ ,  $R_L = 32\Omega$ )

Parameter	Test Conditions		Value	Unit	
Wavebands	FM		87.5 to 108	MHz	
	AM		510 to 1620	kHz	
Sensitivity	FM	S/N = 26dB, $\Delta f = 22.5\text{kHz}$	3	$\mu\text{V}$	
	AM	S/N = 6dB, $m = 0.3$	2	$\mu\text{V}$	
	AM	S/N = 26dB, $m = 0.3$	10	$\mu\text{V}$	
Distortion ( $f_m = 1\text{kHz}$ )	FM	$P_O = 20\text{mW}$ $V_i = 100\mu\text{V}$	$\Delta f = 22.5\text{kHz}$	0.5	%
			$\Delta f = 75\text{kHz}$	1.8	%
	AM	$m = 0.3$	1.1	%	
Signal to Noise ( $f_m = 1\text{kHz}$ )	FM	$P_O = 20\text{mW}$ $V_i = 100\mu\text{V}$	$\Delta f = 22.5\text{kHz}$	60	dB
	AM		$m = 0.3$	45	dB
Amplitude Modulation Rejection	FM	$V_i = 100\mu\text{V}$ , $\Delta f = 22.5\text{kHz}$ , $m = 0.3$	40	dB	
Quiescent Current			16	mA	
Supply Voltage Range			1.6 to 3	V	

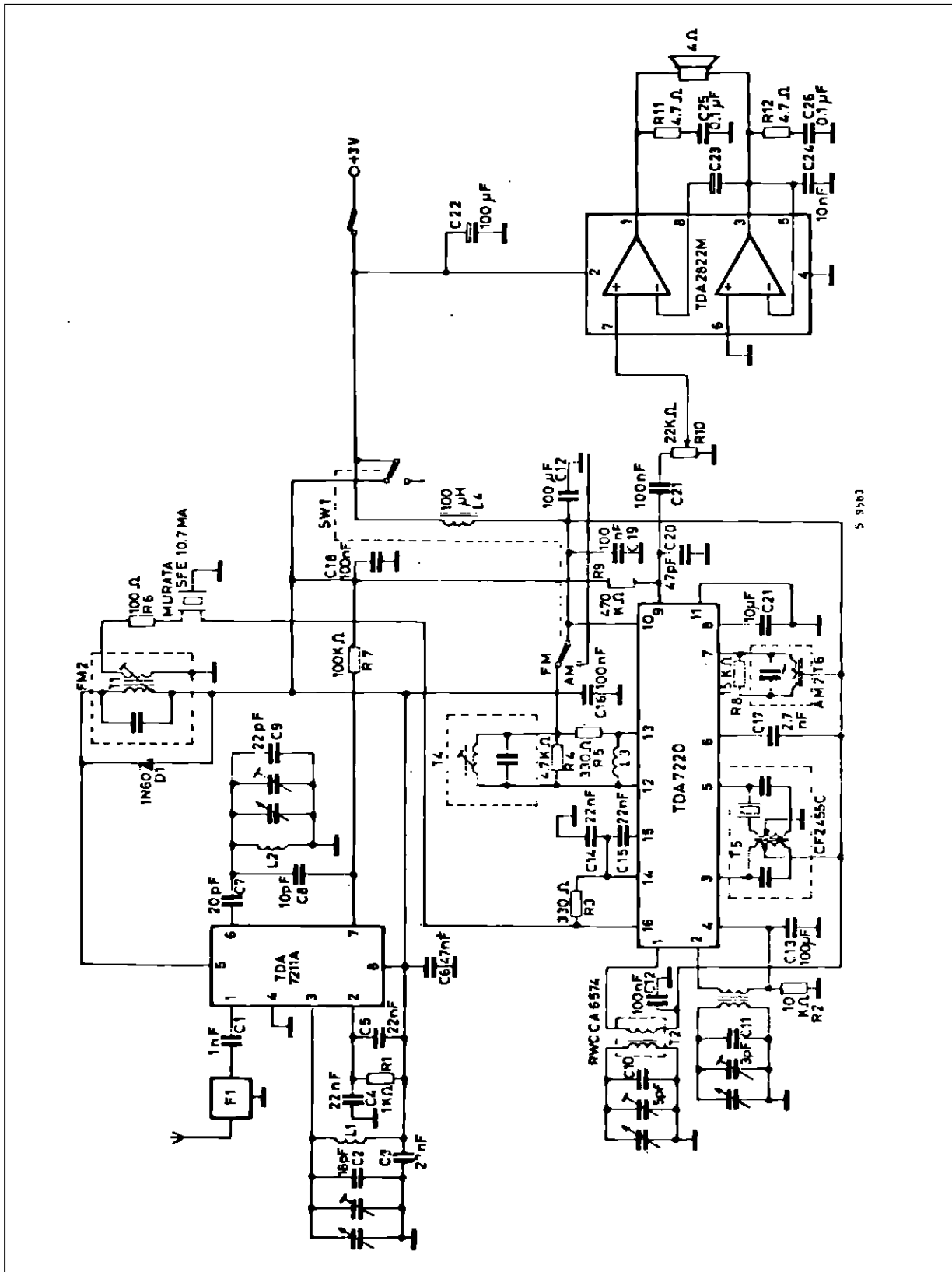
APPLICATION INFORMATION

Figure 18 : Stereo AM/FM Miniradio



5-9580/2

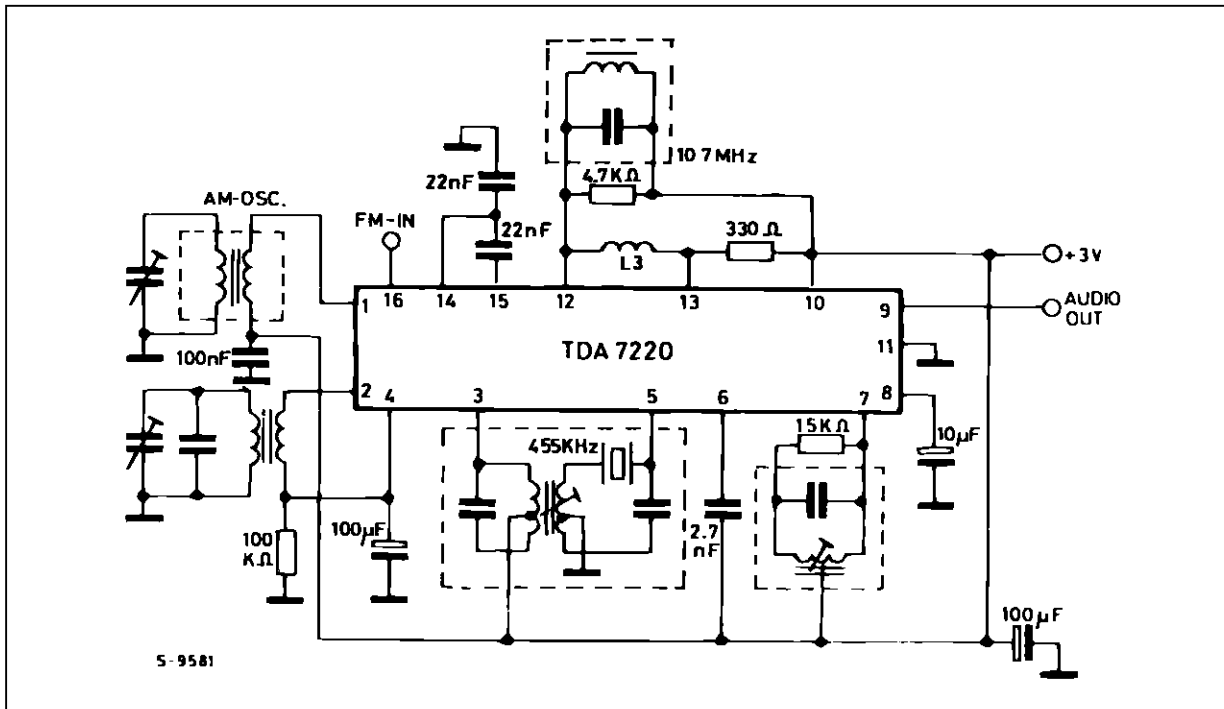
Figure 19 : 0.3W AM/FM Monoradio



5 9563

# TDA7220

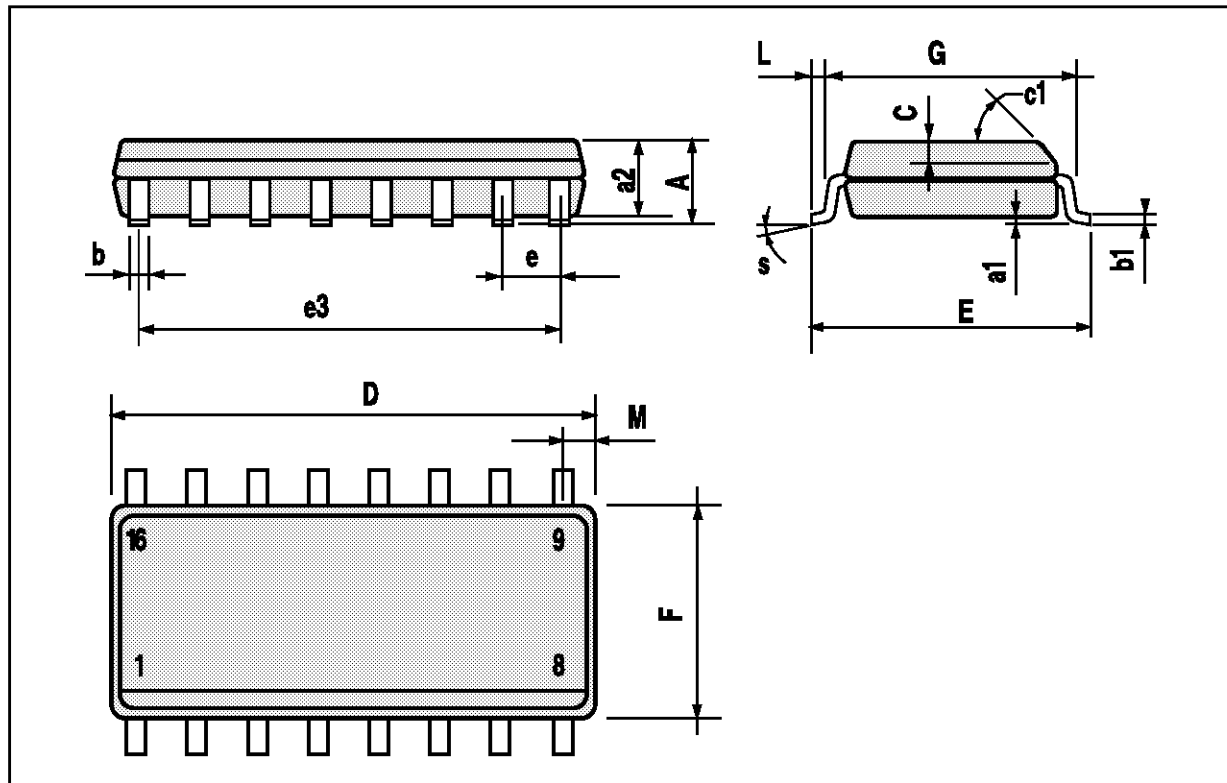
## TYPICAL APPLICATION





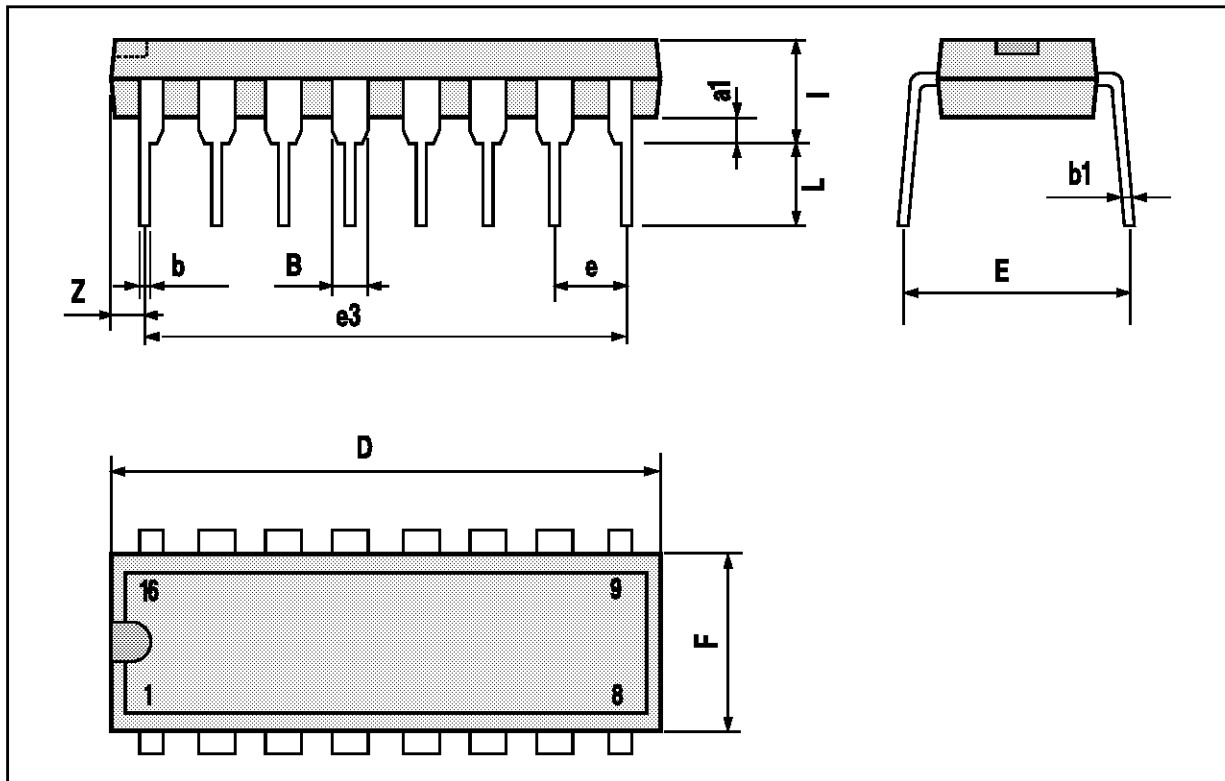
SO16 PACKAGE MECHANICAL DATA

DIM.	mm			inch		
	MIN.	TYP.	MAX.	MIN.	TYP.	MAX.
A			1.75			0.069
a1	0.1		0.25	0.004		0.009
a2			1.6			0.063
b	0.35		0.46	0.014		0.018
b1	0.19		0.25	0.007		0.010
C		0.5			0.020	
c1	45 (typ.)					
D	9.8		10	0.386		0.394
E	5.8		6.2	0.228		0.244
e		1.27			0.050	
e3		8.89			0.350	
F	3.8		4.0	0.150		0.157
L	0.4		1.27	0.016		0.050
M			0.62			0.024
S	8 (max.)					



## DIP16 PACKAGE MECHANICAL DATA

DIM.	mm			inch		
	MIN.	TYP.	MAX.	MIN.	TYP.	MAX.
a1	0.51			0.020		
B	0.77		1.65	0.030		0.065
b		0.5			0.020	
b1		0.25			0.010	
D			20			0.787
E		8.5			0.335	
e		2.54			0.100	
e3		17.78			0.700	
F			7.1			0.280
I			5.1			0.201
L		3.3			0.130	
Z			1.27			0.050



Information furnished is believed to be accurate and reliable. However, SGS-THOMSON Microelectronics assumes no responsibility for the consequences of use of such information nor for any infringement of patents or other rights of third parties which may result from its use. No license is granted by implication or otherwise under any patent or patent rights of SGS-THOMSON Microelectronics. Specifications mentioned in this publication are subject to change without notice. This publication supersedes and replaces all information previously supplied. SGS-THOMSON Microelectronics products are not authorized for use as critical components in life support devices or systems without express written approval of SGS-THOMSON Microelectronics.

© 1994 SGS-THOMSON Microelectronics - All Rights Reserved

SGS-THOMSON Microelectronics GROUP OF COMPANIES

Australia - Brazil - France - Germany - Hong Kong - Italy - Japan - Korea - Malaysia - Malta - Morocco - The Netherlands - Singapore - Spain - Sweden - Switzerland - Taiwan - Thailand - United Kingdom - U.S.A.