

## IRGKIN050M12

"CHOPPER LOW SIDE SWITCH" IGBT INT-A-PAK

Low conduction loss IGBT

- Rugged Design
- Simple gate-drive
- Switching-Loss Rating includes all "tail" losses
- Short circuit rated

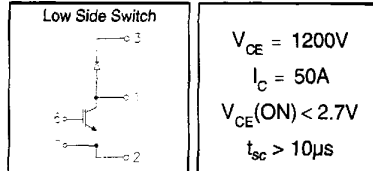

### Description

IR's advanced IGBT technology is the key to this line of INT-A-PAK Power Modules. The efficient geometry and unique processing of the IGBT allow higher current densities than comparable bipolar power module transistors, while at the same time requiring the simpler gate-drive of the familiar power MOSFET. These modules are short circuit rated for applications such as motor control requiring this important feature.

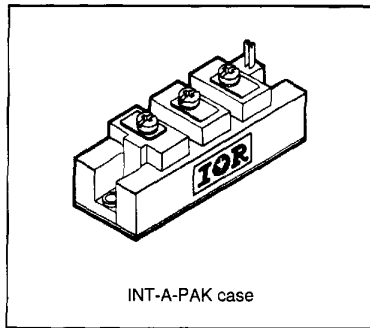

### Absolute Maximum Ratings

Parameter	Description	Value	Units
$V_{CES}$	Continuous collector to emitter voltage	1200	V
$I_C @ T_C = 25^\circ C$	Maximum Continuous collector current	100	A
$I_C @ T_C = 85^\circ C$	Maximum Continuous collector current	65	
$I_C @ T_C = 100^\circ C$	Maximum Continuous collector current	45	
$I_{LM}$	Peak switching current	100	
$I_{FM}$	Peak diode forward current (1)	100	
$V_{GE}$	Gate to emitter voltage	$\pm 20$	V
$V_{ISOL}$	RMS isolation voltage, any terminal to case, $t = 1$ min	2500	
$P_D @ T_C = 25^\circ C$	Power dissipation	455	W
$T_J$	Operating junction temperature range	-40 to 150	$^\circ C$
$T_{STG}$	Storage temperature range	-40 to 125	

(1) Duration limited by max junction temperature.

**Electrical Characteristics -  $T_J = 25^\circ\text{C}$ , unless otherwise stated**

Parameter	Description	Min	Typ	Max	Units	Test Conditions
$BV_{CES}$	Collector-to-emitter breakdown voltage	1200	—	—		$V_{GE} = 0V, I_C = 1.5mA$
$V_{CE(ON)}$	Collector-to-emitter voltage	—	2.2	2.7	V	$V_{GE} = 15V, I_C = 50A$
		—	1.8	—		$V_{GE} = 15V, I_C = 25A, T_J = 150^\circ\text{C}$
$V_{FV}$	Diode forward voltage - maximum	—	3.2	3.4		$I_F = 50A, V_{GE} = 0V$
		—	2.6	—		$I_F = 50A, V_{GE} = 0V, T_J = 150^\circ\text{C}$
$V_{GE(th)}$	Gate threshold voltage	3.0	—	5.5		$I_C = 750\mu A$
$\Delta V_{GE(th)}$	Threshold voltage temp. coefficient	—	-11	—	mV/°C	$V_{CE} = V_{GE}, I_C = 750\mu A$
$g_{fe}$	Forward transconductance	27	—	53	S(Ω)	$V_{CE} = 25V, I_C = 50A$
$I_{CES}$	Collector-to-emitter leakage current	—	—	1.5	mA	$V_{GE} = 0V, V_{CE} = 1200V$
		—	—	15		$V_{GE} = 0V, V_{CE} = 1200V, T_J = 150^\circ\text{C}$
$I_{GES}$	Gate-to-emitter leakage current	—	—	±1.5	μA	$V_{GE} = \pm 20V$

**Dynamic Characteristics -  $T_J = 125^\circ\text{C}$ , unless otherwise stated**

Parameter	Description	Min	Typ	Max	Units	Test Conditions
$E_{on}$	Turn-on switching energy	—	0.19	—		$R_G = 10\Omega, V_{CC} = 600V$
$E_{off}$ (1)	Turn-off switching energy	—	0.36	—	mJ/A	$I_C = 50A, L_S = 100nH$
$E_{ts}$ (1)	Total switching energy	—	—	0.60		$V_{GE} = \pm 15V$
$t_{d(on)}$	Turn-on delay time	—	200	250	ns	$R_G = 10\Omega, V_{CC} = 600V$
$t_r$	Rise time	—	200	250		$I_C = 50A$
$t_{d(off)}$	Turn-off delay time	—	125	200		$V_{GE} = \pm 15V$
$t_f$	Fall time	—	650	—		Resistive load, $T_J = 25^\circ\text{C}$
$I_{rr}$	Diode peak recovery current	—	35	—	A	$R_G = 10\Omega, V_{CC} = 600V$
$t_{rf}$	Diode recovery time	—	215	—	ns	$I_C = 50A$
$Q_{rr}$	Diode recovery charge	—	4.5	—	μC	$V_{GE} = \pm 15V$
$Q_{ge}$	Gate-to-emitter charge (turn-on)	35	—	130	nC	$V_{CC} = 600V$
$Q_{gc}$	Gate-to-collector charge (turn-on)	120	—	250		$I_C = 50A$
$Q_g$	Total gate charge (turn-on)	380	—	680		$V_{GE} = 15V$
$C_{ies}$	Input capacitance	8000	—	8300	pF	$V_{GE} = 0V$
$C_{obs}$	Output capacitance	490	—	820		$V_{CC} = 30V$
$C_{res}$	Reverse transfer capacitance	490	—	750		$f = 1MHz$
$t_{sc}$	Short circuit withstand time	10	—	—	μs	$V_{CC} = 720V, V_{GE} = \pm 15V$ Min. $R_G = 10\Omega, V_{CEP} = 1000V$

(1) Includes tail losses

**Thermal and Mechanical Characteristics**

Parameter	Description	Typ	Max	Units
$R_{th(j-c)}$ (IGBT)	Thermal resistance, junction to case, each IGBT	—	0.275	°C/W
$R_{th(j-c)}$ (Diode)	Thermal resistance, junction to case, each diode	—	0.380	
$R_{th(c-s)}$ (Module)	Thermal resistance, case to sink	0.041	0.100	
Wt	Weight of module	150	—	g

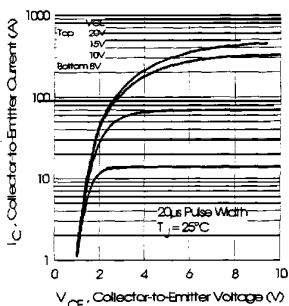

Fig. 1 - Typical Output Characteristics,  $T_j = 25^\circ\text{C}$

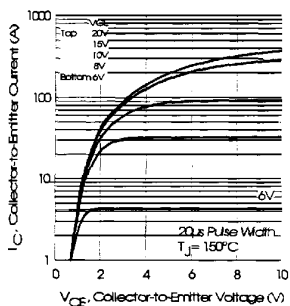

Fig. 2 - Typical Output Characteristics,  $T_j = 150^\circ\text{C}$

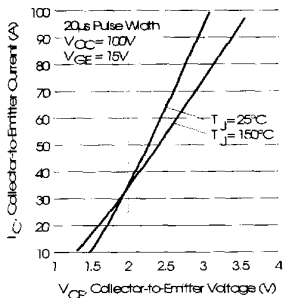

Fig. 3 - Typical Output Characteristics

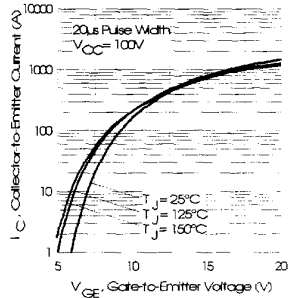

Fig. 4 - Typical Transfer Characteristics

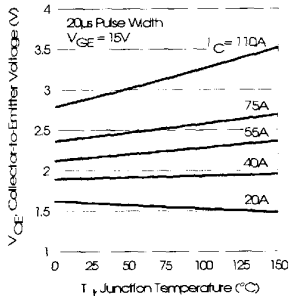

Fig. 5 - Collector-to-Emitter Saturation Typical Voltage vs. Junction Temperature

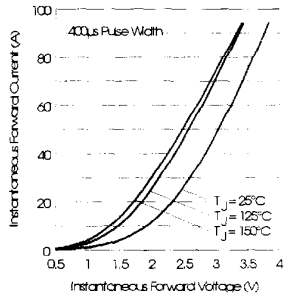

Fig. 6 - Forward Voltage Drop Characteristics



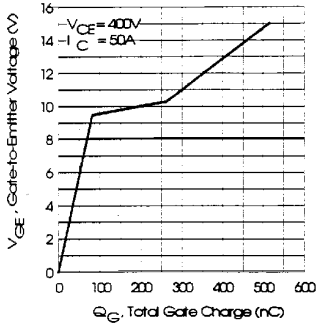

Fig. 7 - Typical Gate Charge vs. Gate-to-Emitter Voltage

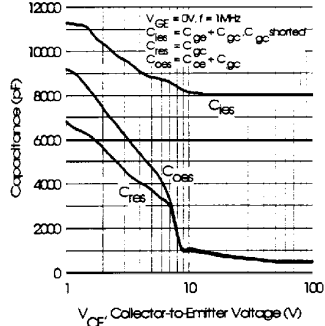

Fig. 8 - Typical Capacitance vs. Collector-to-Emitter Voltage

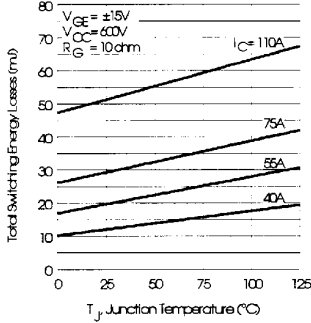

Fig. 9 - Typical Switching Losses vs. Junction Temperature

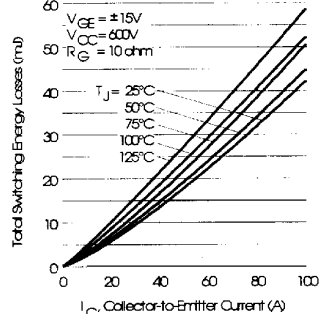

Fig. 10 - Typical Switching Losses vs. Collector-to-Emitter Current

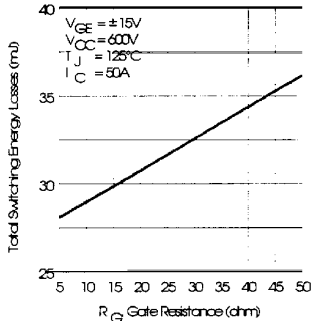

Fig. 11 - Typical Switching Losses vs. Gate Resistance

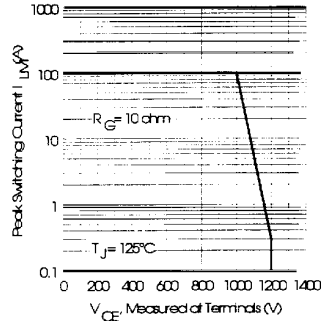

Fig. 12 - Reverse Bias Safe Operating Area

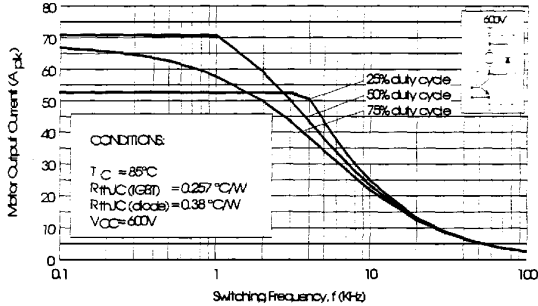

Fig. 13 - RMS Output Current vs. Frequency

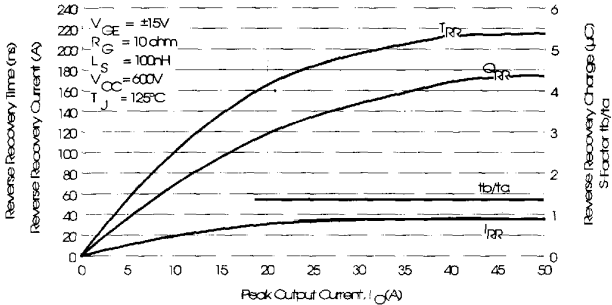

Fig. 14 - Typical Diode Recovery Characteristics as Function of Output Current  $I_O$

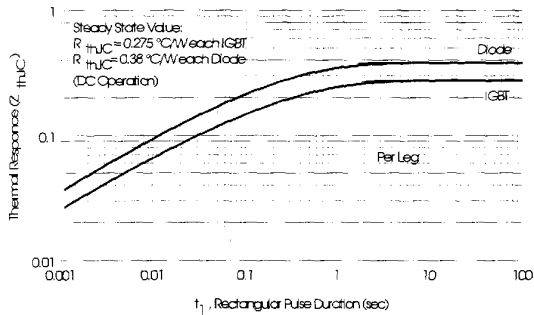

Fig. 15 - Maximum Effective Transient Thermal Impedance, Junction-to-Case

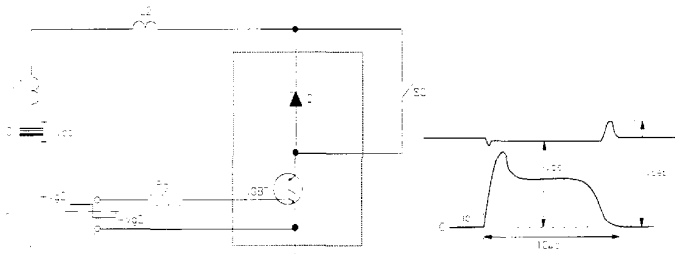

Fig. 16 - Test Circuit for Short Circuit

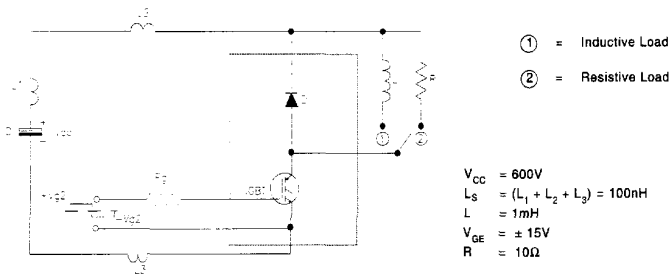

Fig. 17 - Test Circuit for Measurement of  $I_{LM}$ ,  $E_{ON}$ ,  $E_{OFF}$ ,  $Q_{RR}$

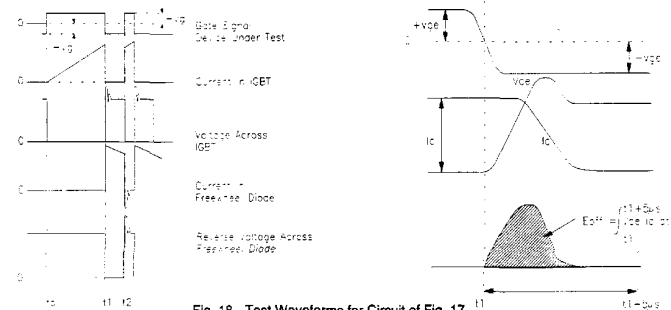

Fig. 18 - Test Waveforms for Circuit of Fig. 17

Refer to Section D for the following:  
**Appendix I: Section D - page D-11**

Fig. 19 - Test Waveforms for Circuit of Fig. 17,

Defining  $E_{ON}$ ,  $E_{REC}$ ,  $Q_{RR}$

Fig. 20 - Waveforms for Switching Time

Package Outline 7- INT-A-PAK, New - Low Side Switch

Section D - page D-15