

<b>SANYO</b>	No.3564A	<b>2SK1426</b>
		N-Channel MOS Silicon FET Very High-Speed Switching Applications

**Features**

- Low ON-state resistance.
- Very high-speed switching.
- Converters.

**Absolute Maximum Ratings at Ta = 25°C**

			unit
Drain to Source Voltage	V <sub>DS</sub>	60	V
Gate to Source Voltage	V <sub>GS</sub>	±20	V
Drain Current(DC)	I <sub>D</sub>	100	A
Drain Current(Pulse)	I <sub>DP</sub>	PW ≤ 10μs, duty cycle ≤ 1%	400 A
Allowable Power Dissipation	P <sub>D</sub>	Tc = 25°C	200 W
			3.5 W
Channel Temperature	T <sub>ch</sub>	150	°C
Storage Temperature	T <sub>stg</sub>	-55 to +150	°C

**Electrical Characteristics at Ta = 25°C**

			min	typ	max	unit
D-S Breakdown Voltage	V <sub>(BR)DSS</sub>	I <sub>D</sub> = 1mA, V <sub>GS</sub> = 0	60			V
Zero Gate Voltage Drain Current	I <sub>DSS</sub>	V <sub>DS</sub> = 60V, V <sub>GS</sub> = 0			100	μA
Gate to Source Leakage Current	I <sub>GSS</sub>	V <sub>GS</sub> = ±20V, V <sub>DS</sub> = 0			±100	nA
Cutoff Voltage	V <sub>GS(off)</sub>	V <sub>DS</sub> = 10V, I <sub>D</sub> = 1mA	1.5		2.5	V
Forward Transfer Admittance	Y <sub>fs</sub>	V <sub>DS</sub> = 10V, I <sub>D</sub> = 60A	40	70		S
Static Drain to Source on State Resistance	R <sub>DS(on)</sub>	I <sub>D</sub> = 60A, V <sub>GS</sub> = 10V	0.008	0.012		Ω
Input Capacitance	C <sub>iss</sub>	V <sub>DS</sub> = 20V, f = 1MHz		7200		pF
Output Capacitance	C <sub>oss</sub>	V <sub>DS</sub> = 20V, f = 1MHz		3300		pF
Reverse Transfer Capacitance	C <sub>rss</sub>	V <sub>DS</sub> = 20V, f = 1MHz		900		pF
Turn-ON Delay Time	t <sub>d(on)</sub>	I <sub>D</sub> = 60A, V <sub>GS</sub> = 10V V <sub>DD</sub> = 30V, R <sub>GS</sub> = 50Ω		78		ns
Rise Time	t <sub>r</sub>		622	ns		
Turn-OFF Delay Time	t <sub>d(off)</sub>		650	ns		
Fall Time	t <sub>f</sub>		600	ns		
Diode Forward Voltage	V <sub>SD</sub>	I <sub>S</sub> = 100A, V <sub>GS</sub> = 0			1.8	V

(Note) Be careful in handling the 2SK1426 because it has no protection diode between gate and source.

**Switching Time Test Circuit**

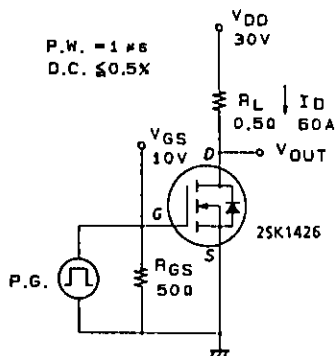

**Package Dimensions 2077**

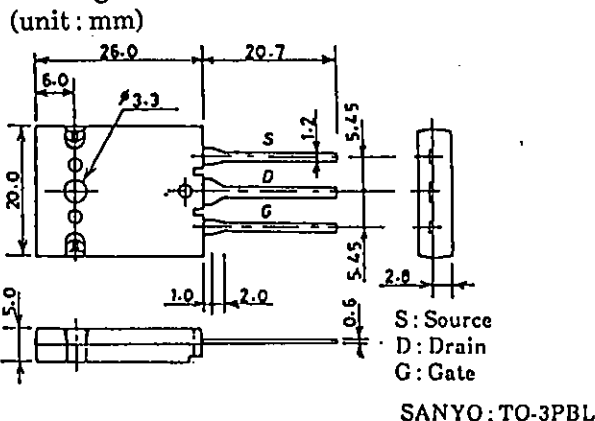

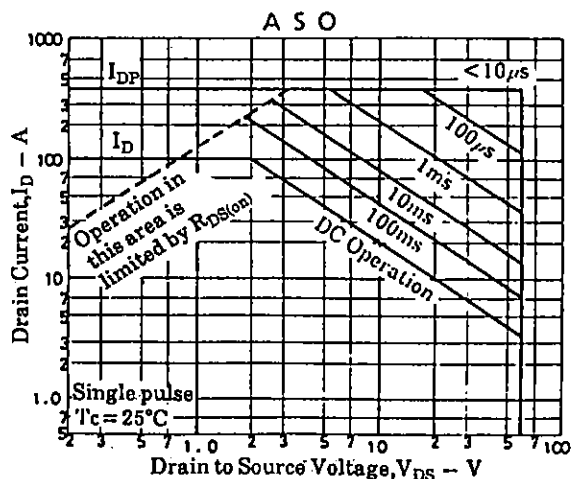
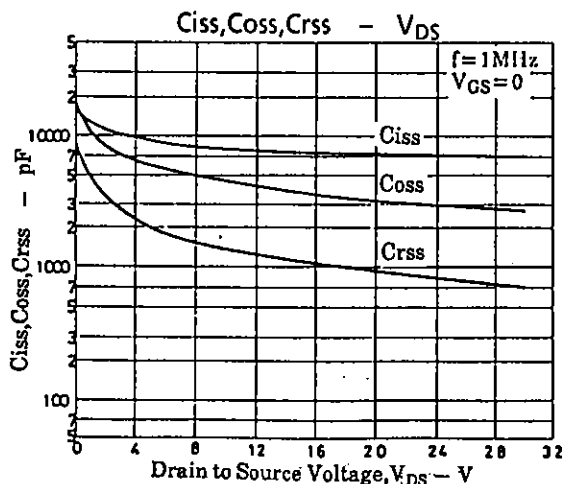
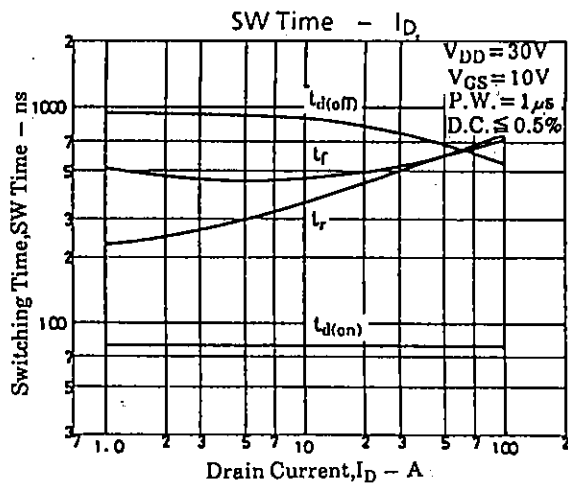
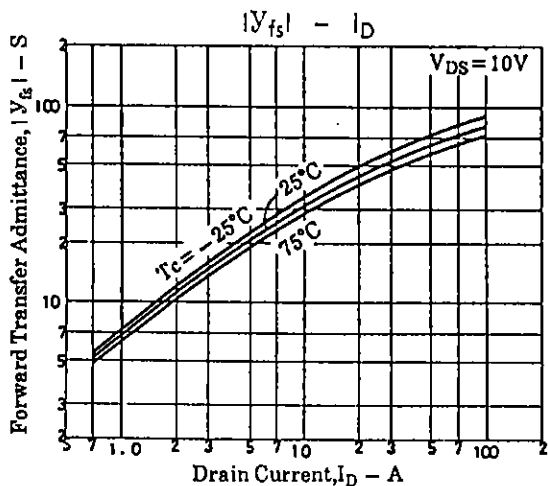
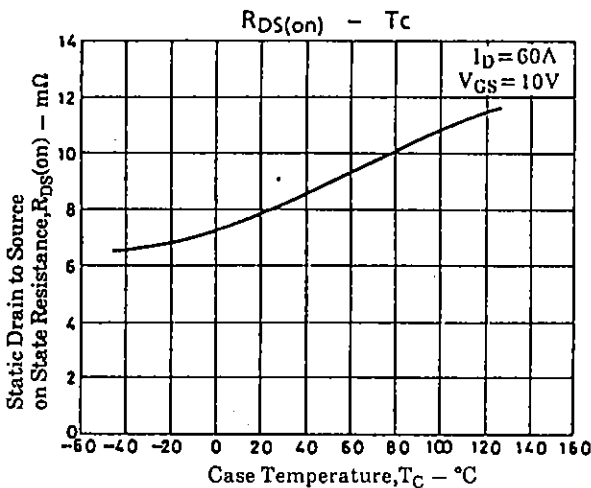
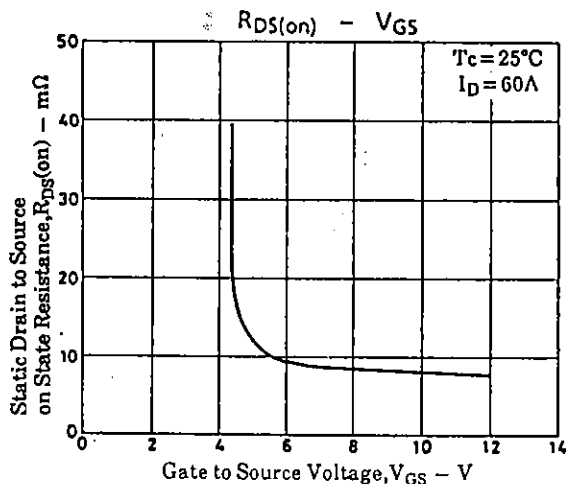
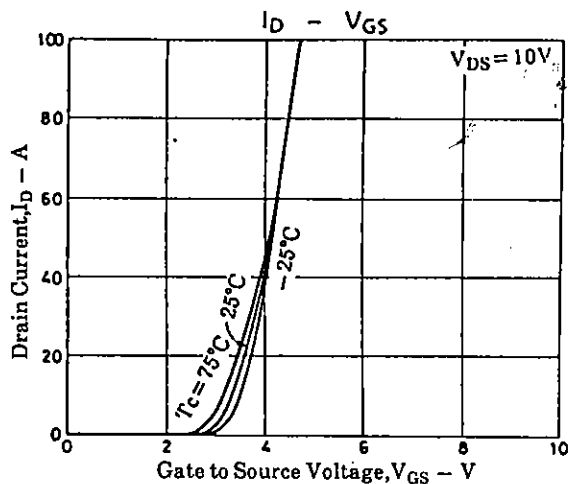
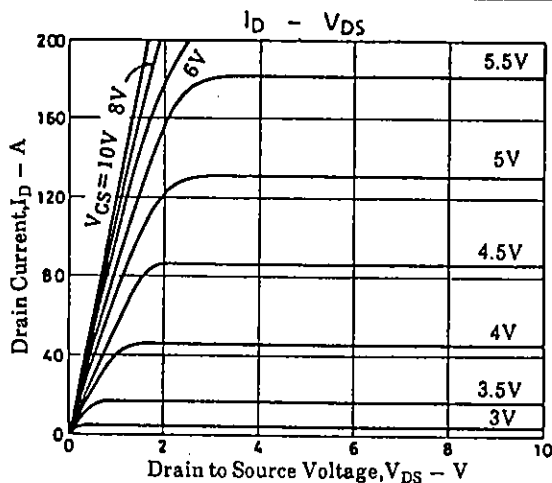

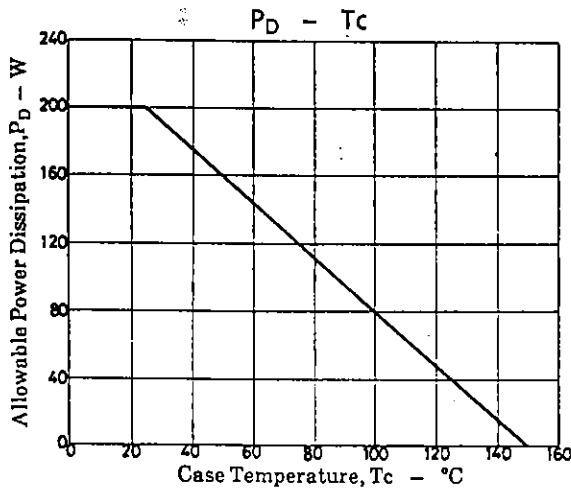
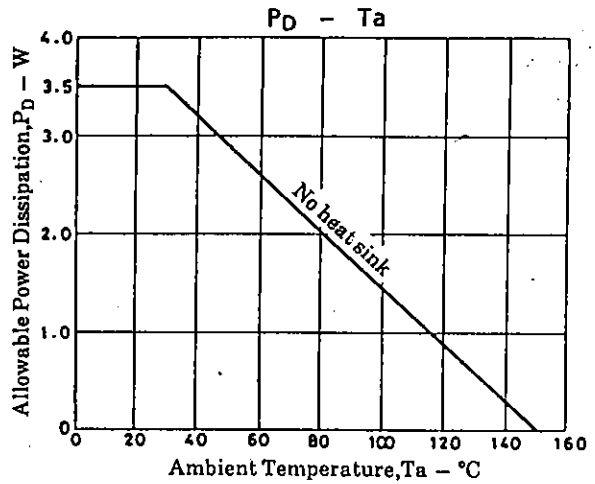
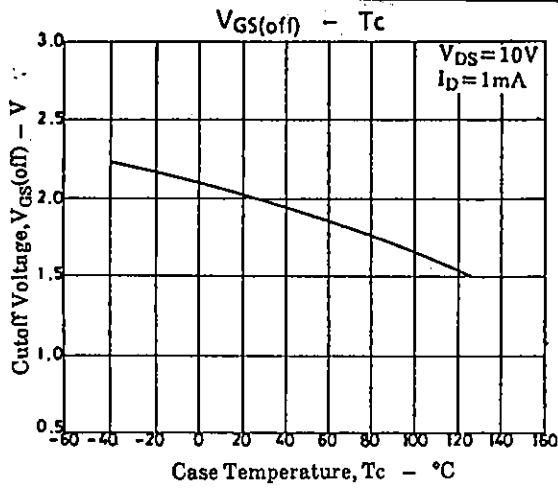

- No products described or contained herein are intended for use in surgical implants, life-support systems, aerospace equipment, nuclear power control systems, vehicles, disaster/crime-prevention equipment and the like, the failure of which may directly or indirectly cause injury, death or property loss.
- Anyone purchasing any products described or contained herein for an above-mentioned use shall:
  - ① Accept full responsibility and indemnify and defend SANYO ELECTRIC CO., LTD., its affiliates, subsidiaries and distributors and all their officers and employees, jointly and severally, against any and all claims and litigation and all damages, cost and expenses associated with such use:
  - ② Not impose any responsibility for any fault or negligence which may be cited in any such claim or litigation on SANYO ELECTRIC CO., LTD., its affiliates, subsidiaries and distributors or any of their officers and employees jointly or severally.
- Information (including circuit diagrams and circuit parameters) herein is for example only; it is not guaranteed for volume production. SANYO believes information herein is accurate and reliable, but no guarantees are made or implied regarding its use or any infringements of intellectual property rights or other rights of third parties.