

# PU3119, PU4119, PU4419

## Package Dimensions

### Silicon NPN Triple-Diffused Planar Type

Power Amplifier, Switching

Complementary Pair with PU3219, PU4219, PU4519

#### Features

- High DC current gain ( $h_{FE}$ )
- Good linearity of DC current gain ( $h_{FE}$ )
- PU3119: 3 NPN elements
- PU4119: 4 NPN elements
- PU4419: 2 NPN elements  $\times$  2 (4 elements in total)

#### Absolute Maximum Ratings ( $T_c=25^\circ\text{C}$ )

Item	Symbol	Value	Unit
Collector-base voltage	$V_{CB0}$	60	V
Collector-emitter voltage	$V_{CE0}$	60	V
Emitter-base voltage	$V_{EB0}$	5	V
Peak collector current	$I_{CP}$	4	A
Collector current	$I_C$	2	A
Power dissipation	$P_D$	15	W
Junction temperature	$T_J$	150	$^\circ\text{C}$
Storage temperature	$T_{stg}$	-55 ~ +150	$^\circ\text{C}$

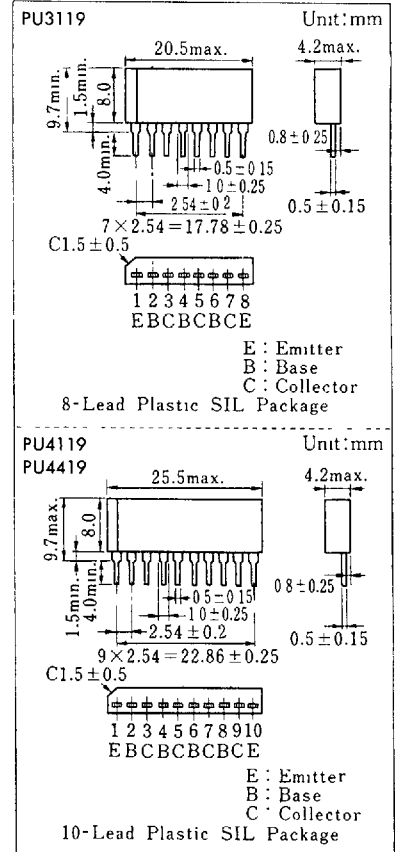

#### Electrical Characteristics ( $T_c=25^\circ\text{C}$ )

Item	Symbol	Condition	min.	typ.	max.	Unit
Collector cutoff current	$I_{CB0}$	$V_{CB} = 60\text{V}, I_F = 0$			1	mA
	$I_{CFO}$	$V_{CE} = 30\text{V}, I_B = 0$			2	mA
Emitter cutoff current	$I_{EBO}$	$V_{EB} = 5\text{V}, I_C = 0$			2	mA
Collector-emitter voltage	$V_{CLO}$	$I_C = 30\text{mA}, I_B = 0$	60			V
DC current gain	$h_{FE1}$	$V_{CE} = 4\text{V}, I_C = 1\text{A}$	1000			
	$h_{FE2}^*$	$V_{CE} = 4\text{V}, I_C = 2\text{A}$	1000		10000	
Base-emitter voltage	$V_{BE}$	$V_{CE} = 4\text{V}, I_C = 2\text{A}$			2.8	V
Collector-emitter saturation voltage	$V_{CE(sat)}$	$I_C = 2\text{A}, I_B = 8\text{mA}$			2.5	V
Transition frequency	$f_T$	$V_{CE} = 10\text{V}, I_C = 0.5\text{A}, f = 1\text{MHz}$		20		MHz
Turn-on time	$t_{on}$	$I_C = 2\text{A}, I_{B1} = 8\text{mA}, I_{B2} = -8\text{mA}$		0.5		$\mu\text{s}$
Storage time	$t_{stg}$			4		$\mu\text{s}$
Fall time	$t_f$			1		$\mu\text{s}$

\* $h_{FE2}$  Classifications

Class	Free	Q	P
$h_{FE2}$	1000 ~ 10000	1000 ~ 5000	2000 ~ 10000

6932852 0017004 800

www.DataSheet4U.com

## Inner Circuit

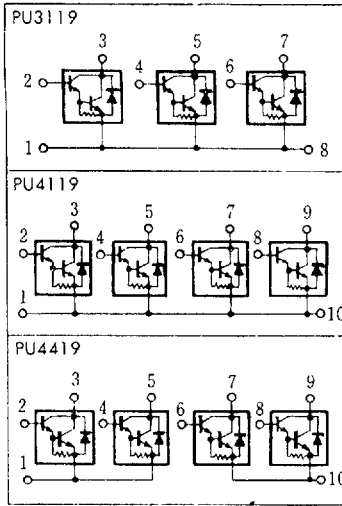

### $P_D - T_a$ (PU3119)

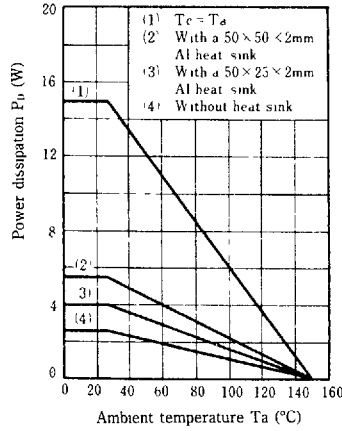

### $P_D - T_a$ (PU4119, PU4419)

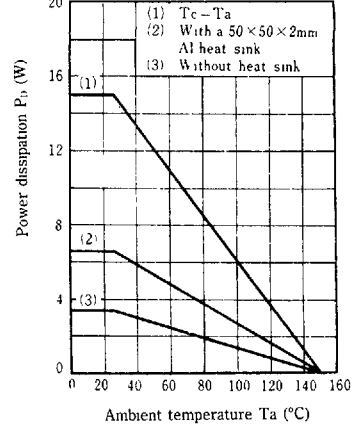

### $I_C - V_{CE}$

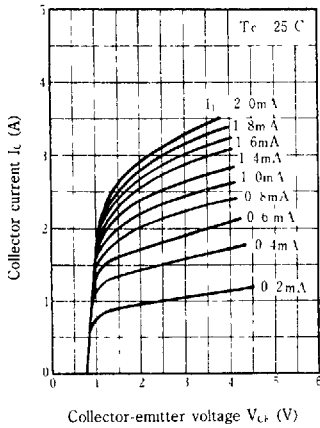

### $I_C - V_{BE}$

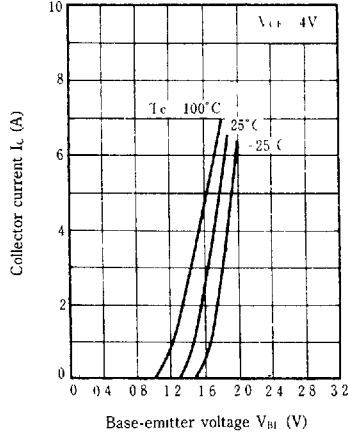

### $V_{CE(sat)} - I_C$

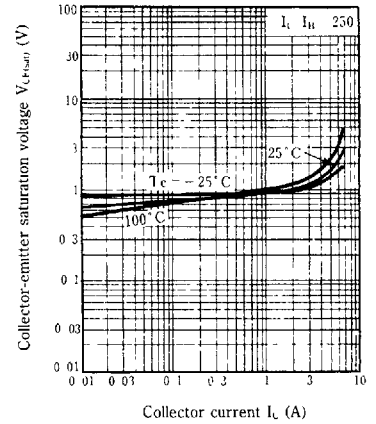

### $h_{FE} - I_C$

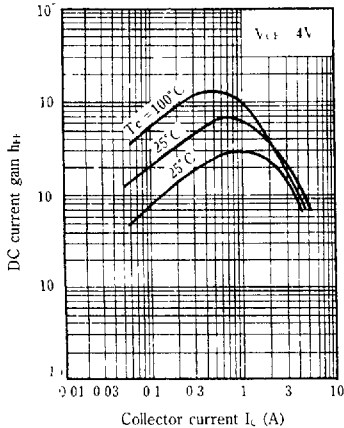

### $C_{ob} - V_{CB}$

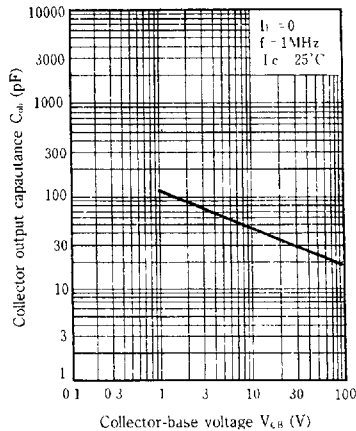

### Area of safe operation (ASO)

