

# NEC

## TFT COLOR LCD MODULE

**NL160120BC27-02**

**54cm (21.3 Type)**

**UXGA**

**PRELIMINARY DATA SHEET** 

(1st edition)

**All information is subject to change without notice.  
Please confirm the delivery specification before starting to  
design your system.**

**INTRODUCTION**

No part of this document shall be copied in any form or by any means without the prior written consent of NEC Corporation.

NEC Corporation does not assume any liability for infringement of patents, copyrights or other intellectual property rights of third parties by or arising from use of a product described herein or any other liability arising from use of such application. No license, express, implied or otherwise, is granted under any patents, copyrights or other intellectual property rights of NEC Corporation or of others.

While NEC Corporation has been making continuous effort to enhance the reliability of its products, the possibility of failures cannot be eliminated entirely. To minimize risks of damage to property or injury to person arising from a failure in an NEC product, customers must incorporate sufficient safety measures in their design, such as redundancy, fire-containment and anti-failure features.

NEC products are classified into the following three quality grades:

*"Standard", "Special", "Specific"*

The *"Specific"* quality grade applies only to applications developed based on a customer designated "quality assurance program" for a specific application. The recommended applications of a product depend on its quality grade, as indicated below. Customers must check the quality grade of each application before using it in a particular application.

**Standard:** Computers, office equipment, communications equipment, test and measurement equipment, audio and visual equipment, home electronic appliances, machine tools, personal electronic equipment and industrial robots

**Special:** Transportation equipment (automobiles, trains, ships, etc.), traffic control systems, anti-disaster systems, anti-crime systems, safety equipment and medical equipment (not specifically designed for life support)

**Specific:** Military systems, aircraft, aerospace equipment, submersible repeaters, nuclear reactor control systems, life support systems (medical equipment, etc.) and any other equipment

The quality grade of this product is *"Standard"* unless otherwise specified in this document. If customers intend to use this product for applications other than those specified for *"Standard"* quality grade, they should contact NEC Corporation sales representative in advance.

Anti-radioactive design is not implemented in this product.

**CONTENTS**

**INTRODUCTION..... 2**

**1. OUTLINE ..... 4**

    1.1 STRUCTURE AND PRINCIPLE ..... 4

    1.2 APPLICATIONS ..... 4

    1.3 FEATURES ..... 4

**2. GENERAL SPECIFICATIONS..... 5**

**3. BLOCK DIAGRAM ..... 6**

**4. DETAILED SPECIFICATIONS..... 7**

    4.1 MECHANICAL SPECIFICATIONS ..... 7

    4.2 ABSOLUTE MAXIMUM RATINGS ..... 7

    4.3 ELECTRICAL CHARACTERISTICS ..... 8

        4.3.1 Driving for LCD panel signal processing board ..... 8

        4.3.2 Driving for backlight lamp ..... 9

        4.3.3 Power supply voltage ripple ..... 10

        4.3.4 Fuses ..... 10

    4.4 POWER SUPPLY VOLTAGE SEQUENCE..... 11

        4.4.1 Sequence for LCD panel signal processing board ..... 11

        4.4.2 Sequence for backlight inverter ..... 11

    4.5 CONNECTIONS AND FUNCTIONS FOR INTERFACE PINS ..... 12

        4.5.1 LCD panel signal processing board ..... 12

        4.5.2 Backlight lamp ..... 13

        4.5.3 Positions of plug and a socket ..... 14

    4.6 LVDS INPUT MODE ..... 15

        4.6.1 Mode A ..... 15

        4.6.2 Mode B ..... 16

        4.6.3 Mode C ..... 17

    4.7 DISPLAY COLORS AND INPUT DATA SIGNALS ..... 18

    4.8 DISPLAY POSITIONS ..... 19

    4.9 SCANNING DIRECTIONS ..... 19

    4.10 INPUT SIGNAL TIMINGS FOR LCD PANEL SIGNAL PROCESSING BOARD ..... 20

        4.10.1 Input signal specifications ..... 20

        4.10.2 Input signal timing chart ..... 20

    4.11 OPTICS ..... 21

        4.11.1 Optical characteristics ..... 21

        4.11.2 Definition of contrast ratio ..... 22

        4.11.3 Definition of luminance uniformity ..... 22

        4.11.4 Definition of response times ..... 22

        4.11.5 Definition of viewing angles ..... 22

**5. RELIABILITY TESTS..... 23**

**6. PRECAUTIONS..... 24**

    6.1 MEANING OF CAUTION SIGNS ..... 24

    6.2 CAUTIONS ..... 24

    6.3 ATTENTIONS ..... 24

        6.3.1 Handling of the product ..... 24

        6.3.2 Environment ..... 25

        6.3.3 Characteristics ..... 25

        6.3.4 Other ..... 25

**7. OUTLINE DRAWINGS ..... 26**

    7.1 FRONT VIEW ..... 26

    7.2 REAR VIEW ..... 27

**REVISION HISTORY ..... 28**

## 1. OUTLINE

### 1.1 STRUCTURE AND PRINCIPLE

NL160120BC27-02 module is composed of the amorphous silicon thin film transistor liquid crystal display (a-Si TFT LCD) panel structure with driver LSIs for driving the TFT (Thin Film Transistor) array and a backlight.

The a-Si TFT LCD panel structure is injected liquid crystal material into a narrow gap between the TFT array glass substrate and a color-filter glass substrate.

Color (Red, Green, Blue) data signals from a host system (e.g. PC, signal generator, etc.) are modulated into best form for active matrix system by a signal processing board, and sent to the driver LSIs which drive the individual TFT arrays.

The TFT array as an electro-optical switch regulates the amount of transmitted light from the backlight assembly, when it is controlled by data signals. Color images are created by regulating the amount of transmitted light through the TFT array of red, green and blue dots.

### 1.2 APPLICATIONS

- EWS monitors
- Monitors for CAD system

### 1.3 FEATURES

- Ultra-wide viewing angle (with lateral electric field)
- High resolution
- Low reflection
- LVDS interface
- High luminance
- Wide color gamut
- Small foot print
- Incorporated edge light type backlight

**2. GENERAL SPECIFICATIONS**

<i>Display area</i>	432.0 (W) × 324.0 (H) mm (typ.)
<i>Diagonal size of display</i>	54 cm (21.3 inches)
<i>Drive system</i>	a-Si TFT active matrix
<i>Display color</i>	16,777,216 colors
<i>Pixel</i>	1600 (H) × 1200 (V) pixels
<i>Pixel arrangement</i>	RGB (Red dot, Green dot, Blue dot) vertical stripe
<i>Dot pitch</i>	0.090 (W) × 0.270 (H) mm
<i>Pixel pitch</i>	0.270 (W) × 0.270 (H) mm
<i>Module size</i>	457.0 (W) × 350.0 (H) × 25.0 (D) mm (typ.)
<i>Weight</i>	(4000) g (typ.)
<i>Contrast ratio</i>	500:1 (typ.)
<i>Viewing angle</i>	At the contrast ratio 10:1 <ul style="list-style-type: none"> <li>• Horizontal: Right side 85° (typ.), Left side 85° (typ.)</li> <li>• Vertical: Up side 85° (typ.), Down side 85° (typ.)</li> </ul>
<i>Designed viewing direction</i>	Viewing angle with optimum grayscale ( $\gamma=2.2$ ): normal axis
<i>Polarizer surface</i>	Antiglare
<i>Polarizer pencil-hardness</i>	2H (min.) [by JIS K5400]
<i>Color gamut</i>	At LCD panel center (72)% (typ.) [against NTSC color space]
<i>Response time</i>	$T_{on} + T_{off}$ (25) ms (typ.)
<i>Luminance</i>	At $IBL= 6.0mArms / lamp$ 250 cd/m <sup>2</sup> (typ.)
<i>Signal system</i>	2 ports LVDS interface (THC63LVD824 THine Electronics, Inc.) RGB 8-bit signals, Data enable signal (DE), Dot clock (CLK)
<i>Power supply voltage</i>	LCD panel signal processing board: 12.0V
<i>Backlight</i>	Edge light type: 6 cold cathode fluorescent lamps
<i>Power consumption</i>	At checkered flag pattern and $IBL= 6.0mArms / lamp$ TBD W (typ.)

3. BLOCK DIAGRAM

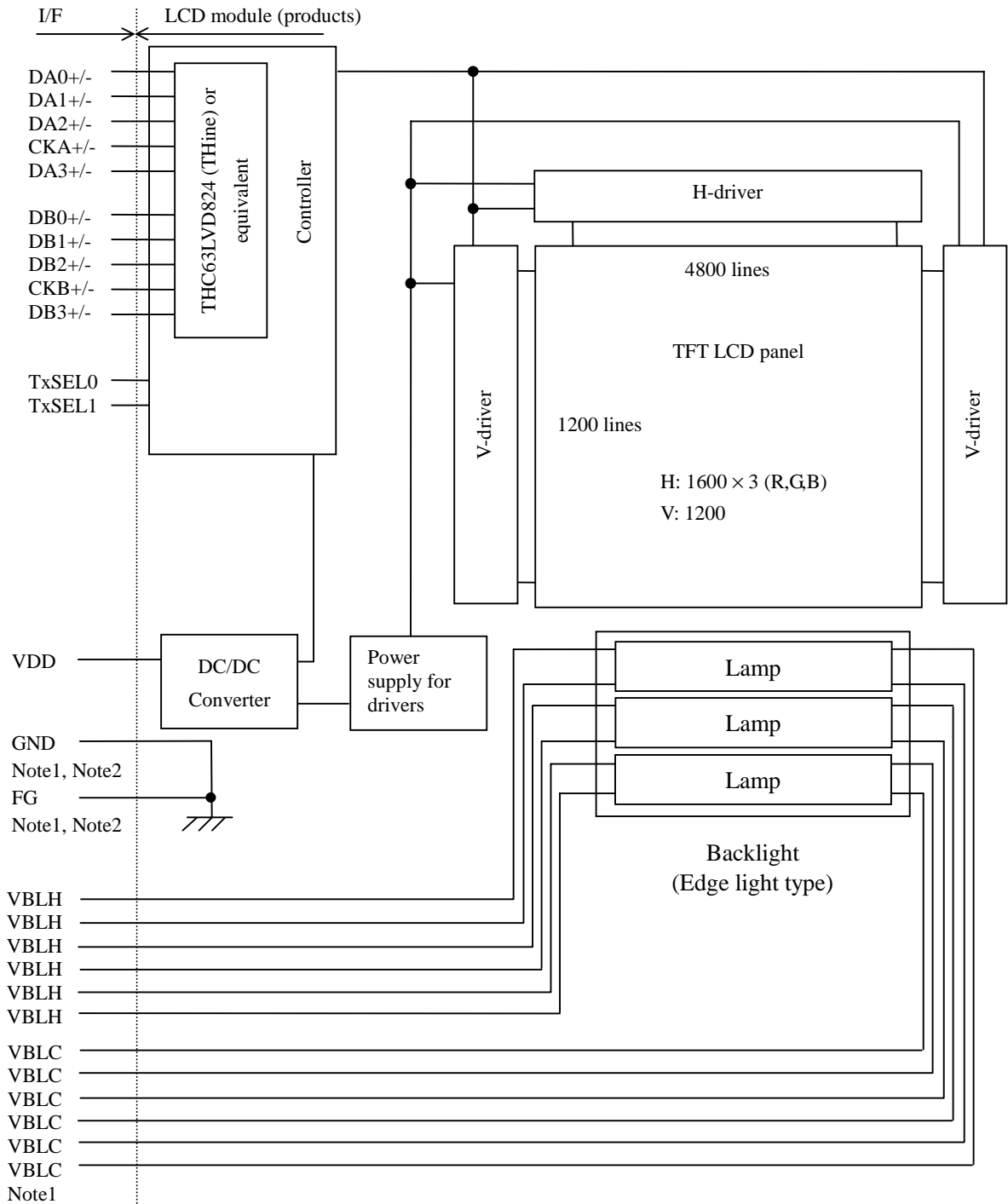

Note1: Connections between GND (Signal ground), FG (Frame ground) and VBLC (Lamp low voltage terminal) in the LCD module

GND - FG	Connected
GND - VBLC	Not connected
FG - VBLC	Not connected

Note2: These grounds should be connected together in customer equipment.

**4. DETAILED SPECIFICATIONS**

**4.1 MECHANICAL SPECIFICATIONS**

Parameter	Specification	Unit
Module size	457.0 ± 1.0 (W) × 350.0 ± 1.0 (H) × 25.0 ± 0.5 (D) <span style="float: right;">Note1</span>	mm
Display area	432.0 (W) × 324.0 (H) <span style="float: right;">Note1</span>	mm
Weight	(4000) (typ.), (4200) (max.)	g

Note1: See "7. OUTLINE DRAWINGS".

**4.2 ABSOLUTE MAXIMUM RATINGS**

Parameter		Symbol	Rating	Unit	Remarks
Power supply voltage	LCD panel signal processing board	VDD	-0.3 to +14.0	V	Ta = 25°C
	Lamp voltage	VBLH	TBD	Vrms	
Input voltage for signals	Display signals Note1	VD	-0.3 to +3.6	V	Ta = 25°C VDD=12.0V
	Function signals Note2	VF	-0.3 to +3.6	V	
Storage temperature		Tst	-20 to +60	°C	-
Operating temperature	Front surface	TopF	0 to +TBD	°C	Note3
	Rear surface	TopR	0 to + TBD	°C	Note4
Relative humidity Note5		RH	≤ 95	%	Ta ≤ 40°C
			≤ 85	%	40 < Ta ≤ 50°C
			≤ 70	%	50 < Ta ≤ 55°C
Absolute humidity Note5		AH	≤ 73 Note6	g/m <sup>3</sup>	Ta > 55°C

Note1: Display signals are DA0+/-, DA1+/-, DA2+/-, DA3+/-, CKA+/-, DB0+/-, DB1+/-, DB2+/-, DB3+/- and CKB+/-.

Note2: Function signals are TxSEL0 and TxSEL1.

Note3: Measured at center of LCD panel surface (including self-heat)

Note4: Measured at center of LCD module's rear shield surface (including self-heat)

Note5: No condensation

Note6: Ta = 55°C, RH = 70%

4.3 ELECTRICAL CHARACTERISTICS

4.3.1 Driving for LCD panel signal processing board

(Ta = 25°C)

Parameter	Symbol	Min.	Typ.	Max.	Unit	Remarks	
Power supply voltage	VDD	10.8	12.0	13.2	V	-	
Power supply current	IDD	-	(550) Note1	TBD Note2	mA	at VDD = 12.0V	
Differential input threshold voltage for Display signals	Low	VTL	-100	-	-	mV	at VCM= 1.2V Note3
	High	VTH	-	-	+100	mV	
Terminating resister	RT	-	100	-	Ω	-	
Input voltage for Function signals	Low	VFL	-	-	0.5	V	TxSEL0, TxSEL1 Note4
Input current for Function signals	Low	IFL	-10	-	10	μA	

Note1: Checkered flag pattern [by EIAJ ED-2522]

Note2: Pattern for maximum current

Note3: Common mode voltage for LVDS receiver

Note4: High must be Open.



4.3.2 Driving for backlight lamp

(Ta=25°C Note1)

Parameter	Symbol	Min.	Typ.	Max.	Unit	Remarks
Lamp current	IBL	TBD	(6.0)	TBD	mArms	at IBL=6.0mArms: 250cd/m <sup>2</sup> Note3
Lamp voltage	VBLH	-	(800)	-	Vrms	Note2, Note3
Lamp starting voltage	VS	(1000)	-	-	Vrms	Ta = 25°C Note2, Note3
		(1300)	-	-	Vrms	Ta = 0°C Note2, Note3
Oscillation frequency	FO	TBD	(56)	TBD	kHz	Note4

Note1: This product consists of 6 backlight lamps, and these specifications are for each lamp.

Note2: The lamp voltage cycle between lamps should be kept on a same phase. "VS" and "VBLH" are the voltage value between low voltage side (Cold) and high voltage side (Hot).

Note3: The asymmetric ratio of working waveform for lamps (Lamp voltage peak ratio, Lamp current peak ratio and waveform space ratio) should be less than 5 % (See the following figure.). If the waveform is asymmetric, DC (Direct current) element apply into the lamp. In this case, a lamp lifetime may be shortened, because a distribution of a lamp enclosure substance inclines toward one side between low voltage terminal (Cold terminal) and high voltage terminal (Hot terminal).

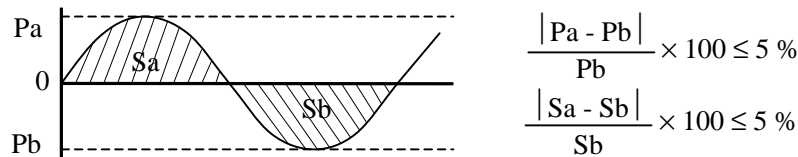

Pa: Supply voltage/current peak for positive, Pb: Supply voltage/current peak for negative  
Sa: Waveform space for positive part, Sb: Waveform space for negative part

Note4: In case "FO" is not the recommended value, beat noise may display on the screen, because of interference between "FO" and "1/th". Recommended value of "FO" is as following.

$$FO = \frac{1}{4} \times \frac{1}{th} \times (2n-1)$$

th: Horizontal cycle period (See "4.10.1 Input signal timings".)

n: Natural number (1, 2, 3 .....)

Note5: Method of lamp cable installation may invite fluctuation of lamp current and voltage or asymmetric of lamp working waveform. When design the backlight inverter, evaluate the fluctuation of lamp current and voltage or asymmetric of lamp working waveform sufficiently.

4.3.3 Power supply voltage ripple

This product works, even if the ripple voltage levels are beyond the permissible values as following the table, but there might be noise on the display image.

Parameter	Power supply voltage	Ripple voltage (Measure at input terminal of power supply)	Note1	Unit
VDD	12.0 V	≤ 100		mVp-p

Note1: The permissible ripple voltage includes spike noise.

4.3.4 Fuses

Parameter	Fuse		Rating	Fusing current	Remarks
	Type	Supplier			
VDD	TBD	TBD	TBD A	TBD A	Note1
			TBD V		

Note1: The power supply capacity should be more than the fusing current. If the power supply capacity is less than the fusing current, the fuse may not blow for a short time, and then nasty smell, smoking and so on may occur.

4.4 POWER SUPPLY VOLTAGE SEQUENCE

4.4.1 Sequence for LCD panel signal processing board

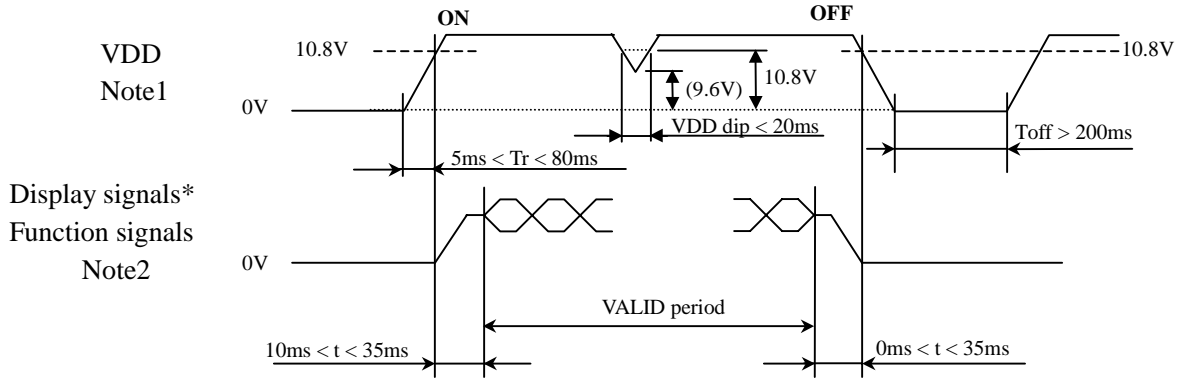

\* These signals should be measured at the terminal of 100Ω resistor.

Note1: In terms of voltage variation (voltage drop) while VDD rising edge is below 10.8V, a protection circuit may work, and then this product may not work.

Note2: Display (DA0+/-, DA1+/-, DA2+/-, DA3+/-, CKA+/-, DB0+/-, DB1+/-, DB2+/-, DB3+/- and CKB+/-) and function (TxSEL0, TxSEL1) signals must be Low or High-impedance, exclude the VALID period (See above sequence diagram), in order to avoid that internal circuits is damaged.

If some of display and function signals of this product are cut while this product is working, even if the signal input to it once again, it might not work normally. If customer stops the display and function signals, they should be cut VDD.

Note3: VDD should be (9.6)V or more while VDD ON period.

4.4.2 Sequence for backlight inverter

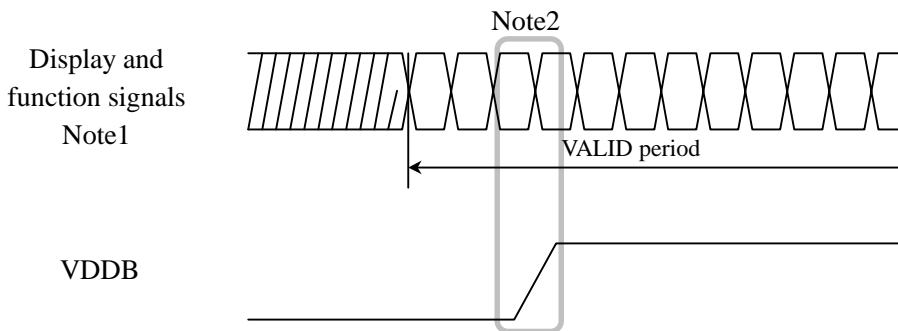

Note1: These are display and function signals for LCD panel signal processing board.

Note2: The backlight inverter voltage (VDDDB) should be inputted within the valid period of display and function signals, in order to avoid unstable data display.

4.5 CONNECTIONS AND FUNCTIONS FOR INTERFACE PINS

4.5.1 LCD panel signal processing board

CN1 socket (LCD module side): DF19G-30P-1H(59) (Hirose Electric Co., Ltd.)

Adaptable plug: DF19-30S-1C (Hirose Electric Co., Ltd.)

Pin No.	Symbol	Function	Description		
1	DA0-	Odd pixel data 0	LVDS differential signal Note1		
2	DA0+				
3	DA1-	Odd pixel data 1			
4	DA1+				
5	DA2-	Odd pixel data 2			
6	DA2+				
7	GND	-	Connect to system ground.		
8	CKA-	Odd pixel clock	LVDS differential signal Note1		
9	CKA+				
10	DA3-	Odd pixel data 3			
11	DA3+				
12	DB0-	Even pixel data 0			
13	DB0+				
14	GND	-	Connect to system ground.		
15	DB1-	Even pixel data 1	LVDS differential signal Note1		
16	DB1+				
17	GND	-		Connect to system ground.	
18	DB2-	Even pixel data 2		LVDS differential signal Note1	
19	DB2+				
20	CKB-	Even pixel clock			
21	CKB+				
22	DB3-	Even pixel data 3			
23	DB3+				
24	GND	-	Connect to system ground.		
25	TxSEL0	Selection of LVDS input mode	Note2, Note3		
			TxSEL0	TxSEL1	Mode
26	TxSEL1		High	High	A
			High	Low	B
			Low	High	C
			Low	Low	A
27	GND	-	Connect to system ground.		
28	VDD	Power supply	-		
29					
30					

Note1: Twist pair wires with 100Ω (Characteristic impedance) should be connected between LCD panel signal processing board and LVDS transmitter.

Note2: This terminal is pulled-up in the product. High must be open.

Note3: See "4.6 LVDS INPUT MODE".

4.5.2 Backlight lamp

**Attention: VBLH and VBLC must be connected correctly. If customer connects wrongly, customer will be hurt and the module will be broken.**

CN201 plug (Module side): BHSR-02VS-1 (J.S.T. Mfg Co., Ltd.)

Adaptable socket: SM02B-BHSS-1-TB (J.S.T. Mfg Co., Ltd.)

Pin No.	Symbol	Function	Remarks
1	VBLH1	Upper side lamp, High voltage (Hot)	Cable color: Pink
2	VBLC1	Upper side lamp, Low voltage (Cold)	Cable color: Gray

CN202 plug (Module side): BHSR-02VS-1 (J.S.T. Mfg Co., Ltd.)

Adaptable socket: SM02B-BHSS-1-TB (J.S.T. Mfg Co., Ltd.)

Pin No.	Symbol	Function	Remarks
1	VBLH2	Upper side lamp, High voltage (Hot)	Cable color: White
2	VBLC2	Upper side lamp, Low voltage (Cold)	Cable color: Gray

CN203 plug (Module side): BHSR-02VS-1 (J.S.T. Mfg Co., Ltd.)

Adaptable socket: SM02B-BHSS-1-TB (J.S.T. Mfg Co., Ltd.)

Pin No.	Symbol	Function	Remarks
1	VBLH3	Upper side lamp, High voltage (Hot)	Cable color: Pink
2	VBLC3	Upper side lamp, Low voltage (Cold)	Cable color: Gray

CN204 plug (Module side): BHSR-02VS-1 (J.S.T. Mfg Co., Ltd.)

Adaptable socket: SM02B-BHSS-1-TB (J.S.T. Mfg Co., Ltd.)

Pin No.	Symbol	Function	Remarks
1	VBLH4	Lower side lamp, High voltage (Hot)	Cable color: Pink
2	VBLC4	Lower side lamp, Low voltage (Cold)	Cable color: Gray

CN205 plug (Module side): BHSR-02VS-1 (J.S.T. Mfg Co., Ltd.)

Adaptable socket: SM02B-BHSS-1-TB (J.S.T. Mfg Co., Ltd.)

Pin No.	Symbol	Function	Remarks
1	VBLH5	Lower side lamp, High voltage (Hot)	Cable color: White
2	VBLC5	Lower side lamp, Low voltage (Cold)	Cable color: Gray

CN206 plug (Module side): BHSR-02VS-1 (J.S.T. Mfg Co., Ltd.)

Adaptable socket: SM02B-BHSS-1-TB (J.S.T. Mfg Co., Ltd.)

Pin No.	Symbol	Function	Remarks
1	VBLH6	Lower side lamp, High voltage (Hot)	Cable color: Pink
2	VBLC6	Lower side lamp, Low voltage (Cold)	Cable color: Gray

4.5.3 Positions of plug and a socket

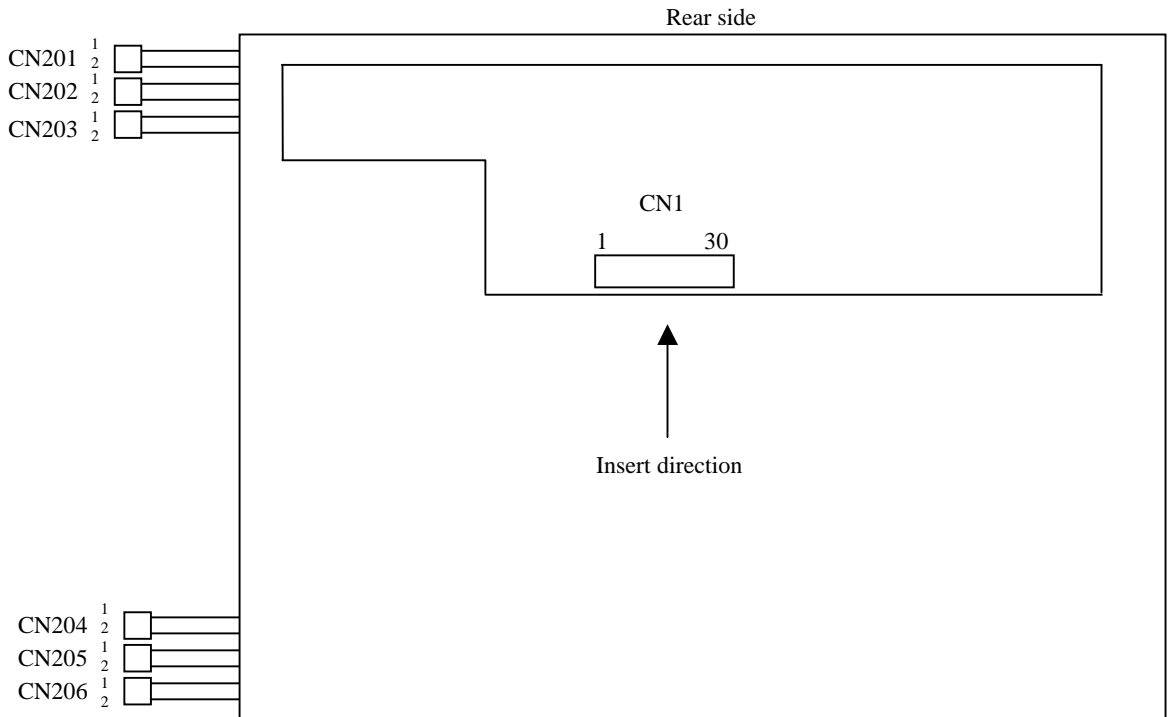

4.6 LVDS INPUT MODE

4.6.1 Mode A

Input data		Transmitter				I/F		THC63LVDS824 or equivalent			
		Pin	THC63LVDF83A	Pin	THC63LVDS823						
Odd pixel data and control signal	RA2 →	51	TA0	53	R12	TA1- →	1	DA0-	→	RA-1	
	RA3 →	52	TA1	54	R13	TA1+ →	2	DA0+	→	RA+1	
	RA4 →	54	TA2	57	R14						
	RA5 →	55	TA3	58	R15						
	RA6 →	56	TA4	59	R16	TB1- →	3	DA1-	→	RB-1	
	RA7 →	3	TA5	60	R17	TB1+ →	4	DA1+	→	RB+1	
	GA2 →	4	TA6	63	G12						
	GA3 →	6	TB0	64	G13	TC1- →	5	DA2-	→	RC-1	
	GA4 →	7	TB1	65	G14	TC1+ →	6	DA2+	→	RC+1	
	GA5 →	11	TB2	66	G15						
	GA6 →	12	TB3	67	G16	TCLK1- →	8	CKA-	→	RCLK-1	
	GA7 →	14	TB4	68	G17	TCLK1+ →	9	CKA+	→	RCLK+1	
	BA2 →	15	TB5	73	B12						
	BA3 →	19	TB6	74	B13	TD1- →	10	DA3-	→	RD-1	
	BA4 →	20	TC0	75	B14	TD1+ →	11	DA3+	→	RD+1	
	BA5 →	22	TC1	76	B15						
	BA6 →	23	TC2	77	B16						
	BA7 →	24	TC3	78	B17						
	RSVD →	27	TC4	7	RSVD						
	RSVD →	28	TC5	8	RSVD						
	DE →	30	TC6	9	DE						
	RA0 →	50	TD0	51	R10						
	RA1 →	2	TD1	52	R11						
	GA0 →	8	TD2	61	G10						
	GA1 →	10	TD3	62	G11						
	BA0 →	16	TD4	69	B10						
	BA1 →	18	TD5	70	B11						
	RSVD →	25	TD6	-	-						
	CLK →	31	CLKIN	10	CLK						
	Even pixel data	RB2 →	51	TA0	81	R22	TA2- →	12	DB0-	→	RA-2
		RB3 →	52	TA1	82	R23	TA2+ →	13	DB0+	→	RA+2
RB4 →		54	TA2	83	R24						
RB5 →		55	TA3	84	R25						
RB6 →		56	TA4	85	R26	TB2- →	15	DB1-	→	RB-2	
RB7 →		3	TA5	86	R27	TB2+ →	16	DB1+	→	RB+2	
GB2 →		4	TA6	91	G22						
GB3 →		6	TB0	92	G23	TC2- →	18	DB2-	→	RC-2	
GB4 →		7	TB1	93	G24	TC2+ →	19	DB2+	→	RC+2	
GB5 →		11	TB2	94	G25						
GB6 →		12	TB3	95	G26	TCLK2- →	20	CKB-	→	RCLK-2	
GB7 →		14	TB4	96	G27	TCLK2+ →	21	CKB+	→	RCLK+2	
BB2 →		15	TB5	99	B22						
BB3 →		19	TB6	100	B23	TD2- →	22	DB3-	→	RD-2	
BB4 →		20	TC0	1	B24	TD2+ →	23	DB3+	→	RD+2	
BB5 →		22	TC1	2	B25						
BB6 →		23	TC2	5	B26						
BB7 →		24	TC3	6	B27						
RSVD →		27	TC4	-	-						
RSVD →		28	TC5	-	-						
RSVD →		30	TC6	-	-						
RB0 →		50	TD0	79	R20						
RB1 →		2	TD1	80	R21						
GB0 →		8	TD2	89	G20						
GB1 →		10	TD3	90	G21						
BB0 →		16	TD4	97	B20						
BB1 →		18	TD5	98	B21						
RSVD →		25	TD6	-	-						
CLK →		31	CLKIN	-	-						

Note1: RSVD must be connected to system ground

4.6.2 Mode B

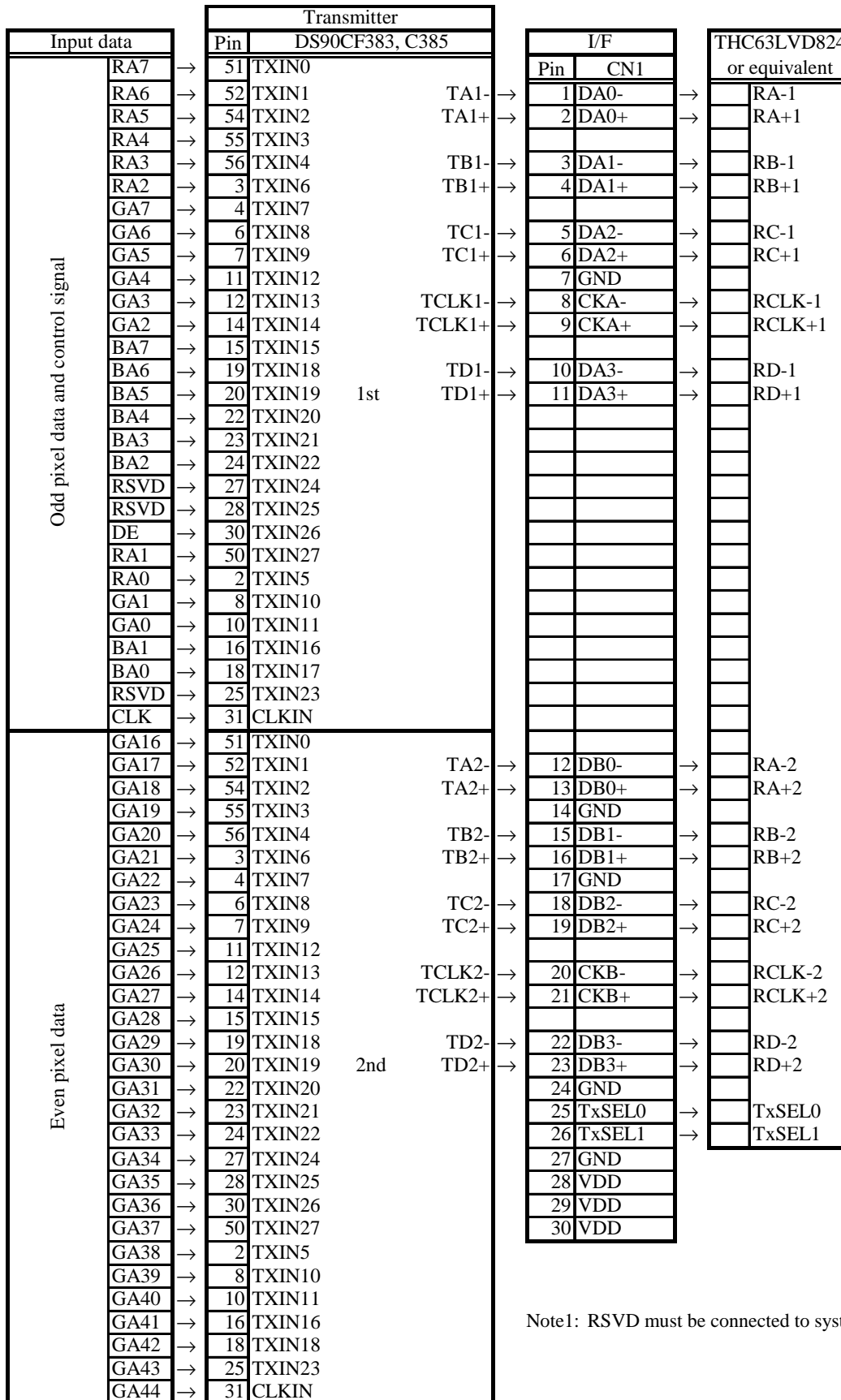

Note1: RSVD must be connected to system ground



4.6.3 Mode C

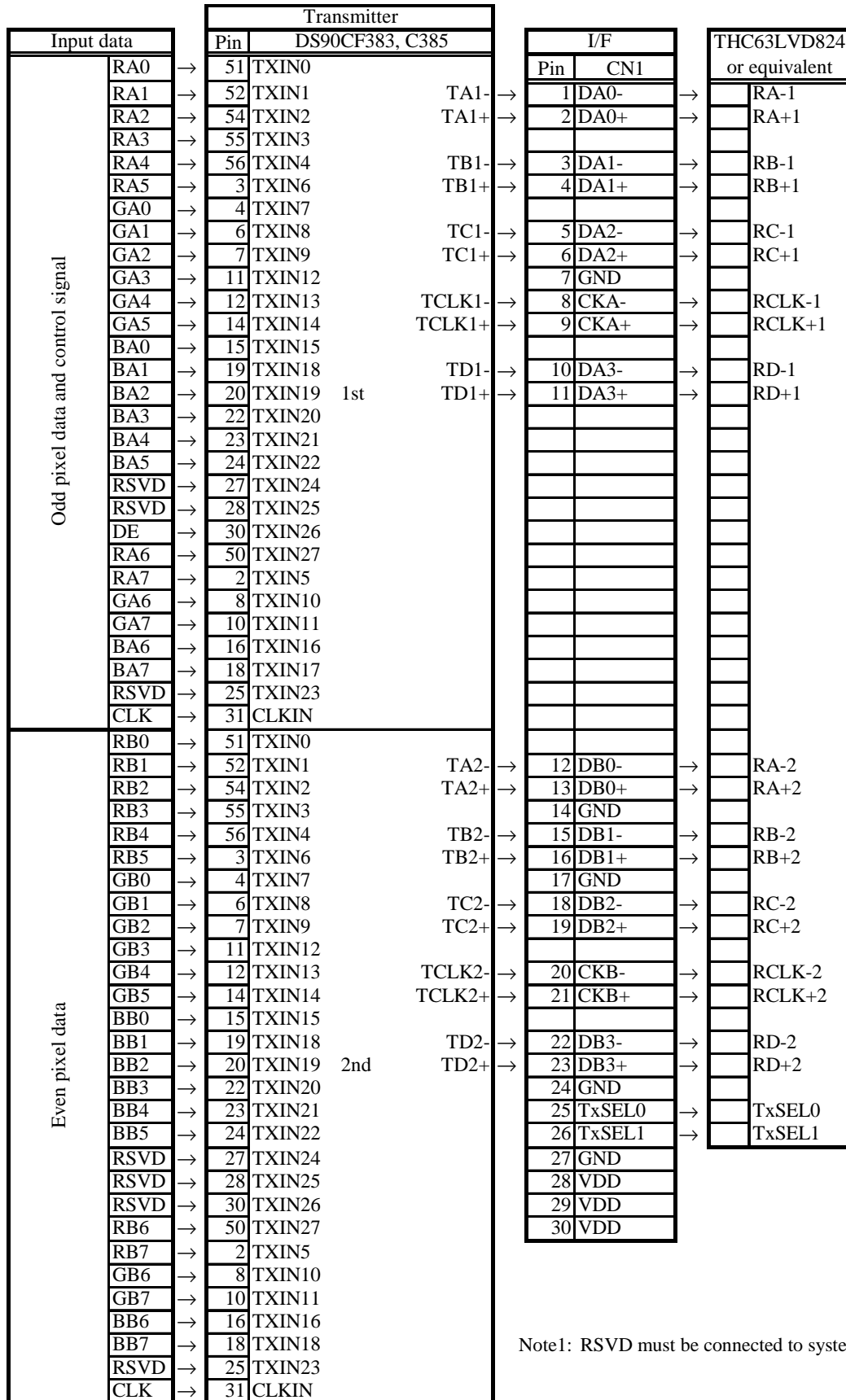

Note1: RSVD must be connected to system ground

4.7 DISPLAY COLORS AND INPUT DATA SIGNALS

This product can display in equivalent to 16,777,216 colors in 256 scale. Also the relation between display colors and input data signals is as the following table.

Display colors		Data signal (0: Low level, 1: High level)																							
		RA7 RA6 RA5 RA4 RA3 RA2 RA1 RA0								GA7 GA6 GA5 GA4 GA3 GA2 GA1 GA0								BA7 BA6 BA5 BA4 BA3 BA2 BA1 BA0							
		RB7 RB6 RB5 RB4 RB3 RB2 RB1 RB0								GB7 GB6 GB5 GB4 GB3 GB2 GB1 GB0								BB7 BB6 BB5 BB4 BB3 BB2 BB1 BB0							
Basic Colors	Black	0	0	0	0	0	0	0	0	0	0	0	0	0	0	0	0	0	0	0	0	0	0	0	0
	Blue	0	0	0	0	0	0	0	0	0	0	0	0	0	0	0	0	1	1	1	1	1	1	1	1
	Red	1	1	1	1	1	1	1	1	0	0	0	0	0	0	0	0	0	0	0	0	0	0	0	0
	Magenta	1	1	1	1	1	1	1	1	0	0	0	0	0	0	0	0	1	1	1	1	1	1	1	1
	Green	0	0	0	0	0	0	0	0	1	1	1	1	1	1	1	1	0	0	0	0	0	0	0	0
	Cyan	0	0	0	0	0	0	0	0	1	1	1	1	1	1	1	1	1	1	1	1	1	1	1	1
	Yellow	1	1	1	1	1	1	1	1	1	1	1	1	1	1	1	1	0	0	0	0	0	0	0	0
	White	1	1	1	1	1	1	1	1	1	1	1	1	1	1	1	1	1	1	1	1	1	1	1	1
Red grayscale	Black	0	0	0	0	0	0	0	0	0	0	0	0	0	0	0	0	0	0	0	0	0	0	0	0
		0	0	0	0	0	0	0	1	0	0	0	0	0	0	0	0	0	0	0	0	0	0	0	0
	dark	0	0	0	0	0	0	1	0	0	0	0	0	0	0	0	0	0	0	0	0	0	0	0	0
	↑																								
	↓																								
bright	1	1	1	1	1	1	0	1	0	0	0	0	0	0	0	0	0	0	0	0	0	0	0	0	
	1	1	1	1	1	1	1	0	0	0	0	0	0	0	0	0	0	0	0	0	0	0	0	0	
Red	1	1	1	1	1	1	1	1	0	0	0	0	0	0	0	0	0	0	0	0	0	0	0	0	
Green grayscale	Black	0	0	0	0	0	0	0	0	0	0	0	0	0	0	0	0	0	0	0	0	0	0	0	0
		0	0	0	0	0	0	0	0	0	0	0	0	0	0	0	1	0	0	0	0	0	0	0	0
	dark	0	0	0	0	0	0	0	0	0	0	0	0	0	0	1	0	0	0	0	0	0	0	0	0
	↑																								
	↓																								
bright	0	0	0	0	0	0	0	0	1	1	1	1	1	1	0	1	0	0	0	0	0	0	0	0	
	0	0	0	0	0	0	0	0	1	1	1	1	1	1	1	0	0	0	0	0	0	0	0	0	
Green	0	0	0	0	0	0	0	0	1	1	1	1	1	1	1	1	0	0	0	0	0	0	0	0	
Blue grayscale	Black	0	0	0	0	0	0	0	0	0	0	0	0	0	0	0	0	0	0	0	0	0	0	0	0
		0	0	0	0	0	0	0	0	0	0	0	0	0	0	0	0	0	0	0	0	0	0	0	1
	dark	0	0	0	0	0	0	0	0	0	0	0	0	0	0	0	0	0	0	0	0	0	0	1	0
	↑																								
	↓																								
bright	0	0	0	0	0	0	0	0	0	0	0	0	0	0	0	0	1	1	1	1	1	1	0	1	
	0	0	0	0	0	0	0	0	0	0	0	0	0	0	0	0	1	1	1	1	1	1	1	0	
Blue	0	0	0	0	0	0	0	0	0	0	0	0	0	0	0	0	1	1	1	1	1	1	1	1	

**4.8 DISPLAY POSITIONS**

The following table is the coordinates per pixel (See "4.9 SCANNING DIRECTIONS").

C (0, 0)			C (1, 0)				
RA	GA	BA	RB	GB	BB		
↑							
C( 0, 0)	C( 1, 0)	...	C( X, 0)	...	C(1598, 0)	C(1599, 0)	
C( 0, 1)	C( 1, 1)	...	C( X, 1)	...	C(1598, 1)	C(1599, 1)	
·	·	·	·	·	·	·	
·	·	·	·	·	·	·	
·	·	·	·	·	·	·	
C( 0, Y)	C( 1, Y)	...	C( X, Y)	...	C(1598, Y)	C(1599, Y)	
·	·	·	·	·	·	·	
·	·	·	·	·	·	·	
·	·	·	·	·	·	·	
C( 0, 1198)	C( 1, 1198)	...	C( X, 1198)	...	C(1598, 1198)	C(1599, 1198)	
C( 0, 1199)	C( 1, 1199)	...	C( X, 1199)	...	C(1598, 1199)	C(1599, 1199)	

**4.9 SCANNING DIRECTIONS**

The following figures are seen from a front view. Also the arrow shows the direction of scan.

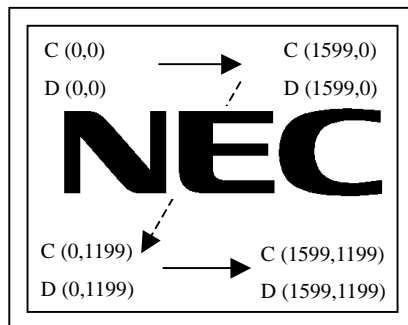

Note1

Note1: Meaning of C (X, Y) and D (X, Y)

C (X, Y): The coordinates of the display position (See "4.8 DISPLAY POSITIONS".)

D (X, Y): The data number of input signal for LCD panel signal processing board

4.10 INPUT SIGNAL TIMINGS FOR LCD PANEL SIGNAL PROCESSING BOARD

4.10.1 Input signal timings

Parameter		Symbol	min.	typ.	max.	Unit	Remarks
CLK	Frequency	1/ tc	(60.7) (16.5)	81.0 12.3	82.0 12.2	MHz ns	-
	Duty	tcl / tc	See the data sheet of LVDS transmitter.			-	Note1
	Rise, fall	trf				ns	
Horizontal	Cycle period	th	(13.8) (840)	13.3 1080	- -	μs CLK	typ.=75.0kHz Note 2, Note3
	Display period	thd	800			CLK	-
Vertical	Cycle period	tv	- -	16.667 1250	17.24 -	ms H	typ.=60.0Hz
	Display period	tvd	1200			H	-
DATA	DATA-CLK (Set up)	ts	See the data sheet of LVDS transmitter.			ns	Note1
	CLK-DATA (Hold)	th				ns	
	Rise, fall	trf				ns	

Note1: Timing specifications are defined by the input signals of LVDS transmitter.

THC63LVD824 (THine) or equivalent products are recommended for LVDS transmitter.

Note2: Both of “time” and “CLK number” of the “th” must keep the Minimum value of specification.

Note3: During operation, fluctuation of horizontal cycle period must not exceed ±1 CLK.

Otherwise function errors will occur in LCD module.

e.g.: Acceptable fluctuation range is 1079-1081 CLK, when the horizontal cycle period is 1080 CLK.

4.10.2 Input signal timing chart

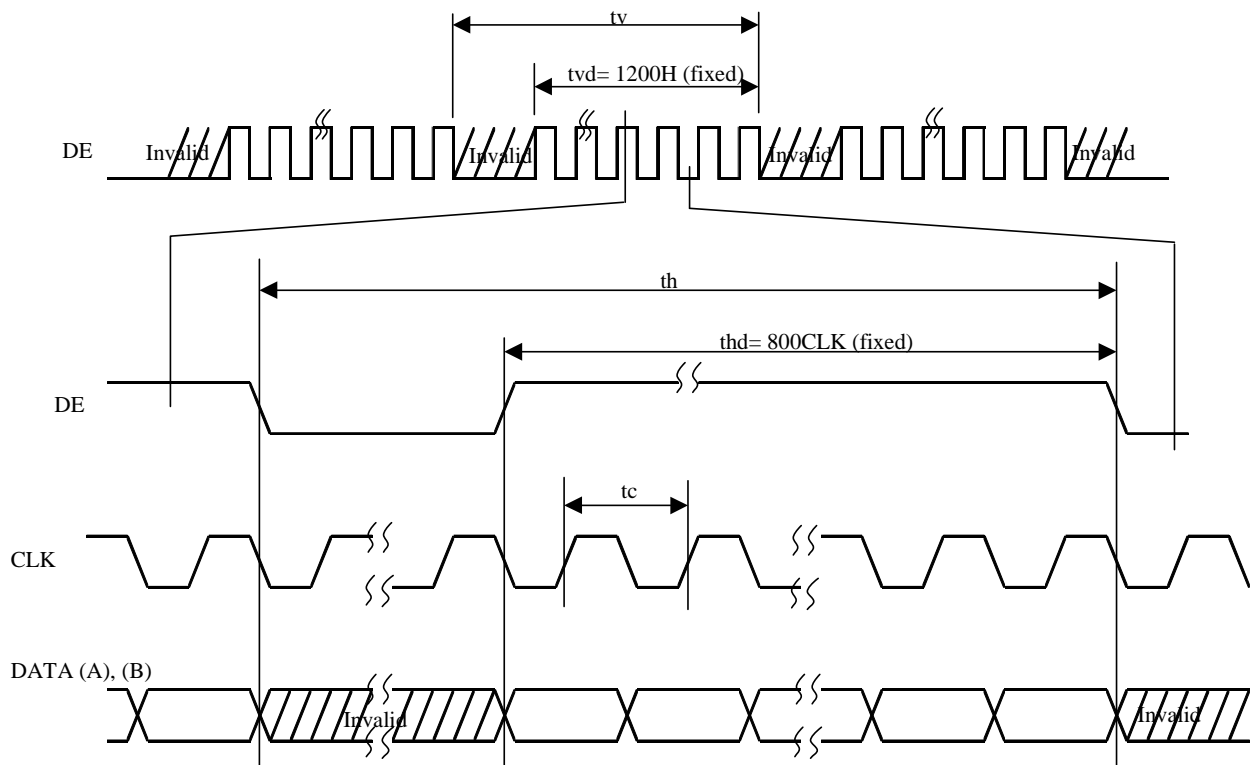

4.11 OPTICS

4.11.1 Optical characteristics

Parameter	Note1	Condition	Symbol	Min.	Typ.	Max.	Unit	Remarks
Luminance		White at center $\theta R = 0^\circ, \theta L = 0^\circ, \theta U = 0^\circ, \theta D = 0^\circ$	L	TBD	250	-	cd/m <sup>2</sup>	-
Contrast ratio		White/Black at center $\theta R = 0^\circ, \theta L = 0^\circ, \theta U = 0^\circ, \theta D = 0^\circ$	CR	TBD	500	-	-	Note2
Luminance uniformity		-	LU	-	1.1	1.3	-	Note3
Chromaticity	White	x coordinate	Wx	-	0.313	-	-	Note4
		y coordinate	Wy	-	0.329	-	-	
	Red	x coordinate	Rx	-	TBD	-	-	
		y coordinate	Ry	-	TBD	-	-	
	Green	x coordinate	Gx	-	TBD	-	-	
		y coordinate	Gy	-	TBD	-	-	
Blue	x coordinate	Bx	-	TBD	-	-		
	y coordinate	By	-	TBD	-	-		
Color gamut		$\theta R = 0^\circ, \theta L = 0^\circ, \theta U = 0^\circ, \theta D = 0^\circ$ at center, against NTSC color space	C	TBD	(72)	-	%	
Response time		Black to White	Ton	-	TBD	TBD	ms	Note5 Note6
		White to Black	Toff	-	TBD	TBD	ms	
		Ton + Toff			-	(25)	-	ms
Viewing angle	Right	$\theta U = 0^\circ, \theta D = 0^\circ, CR = 10$	$\theta R$	70	85	-	°	Note7
	Left	$\theta U = 0^\circ, \theta D = 0^\circ, CR = 10$	$\theta L$	70	85	-	°	
	Up	$\theta R = 0^\circ, \theta L = 0^\circ, CR = 10$	$\theta U$	70	85	-	°	
	Down	$\theta R = 0^\circ, \theta L = 0^\circ, CR = 10$	$\theta D$	70	85	-	°	

Note1: Measurement conditions are as follows.

Ta = 25°C, VDD = 12V, IBL = 6.0mArms/lamp, Display mode: UXGA, Horizontal cycle = 75.0kHz, Vertical cycle = 60.0Hz

Optical characteristics are measured at luminance saturation after 20 minutes from working the product, in the dark room. Also measurement method for luminance is as follows.

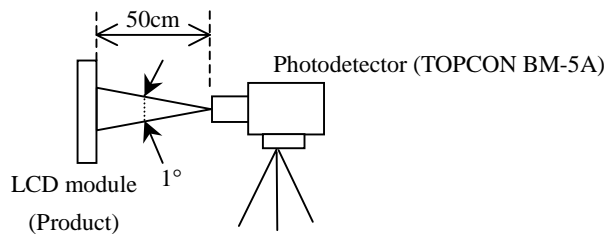

Note2: See "4.11.2 Definition of contrast ratio".

Note3: See "4.11.3 Definition of luminance uniformity".

Note4: These coordinates are found on CIE 1931 chromaticity diagram.

Note5: Product surface temperature: TopF = TBD°C

Note6: See "4.11.4 Definition of response times".

Note7: See "4.11.5 Definition of viewing angles".

4.11.2 Definition of contrast ratio

The contrast ratio is calculated by using the following formula.

$$\text{Contrast ratio (CR)} = \frac{\text{Luminance of white screen}}{\text{Luminance of black screen}}$$

4.11.3 Definition of luminance uniformity

The luminance uniformity is calculated by using following formula.

$$\text{Luminance uniformity (LU)} = \frac{\text{Maximum luminance from ① to ⑤}}{\text{Minimum luminance from ① to ⑤}}$$

The luminance is measured at near the 5 points shown below.

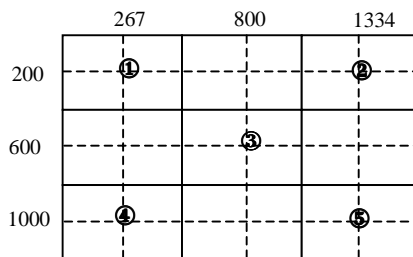

4.11.4 Definition of response times

Response time is measured, the luminance changes from "black" to "white", or "white" to "black" on the same screen point, by photo-detector. Ton is the time it takes the luminance change from 10% up to 90%. Also Toff is the time it takes the luminance change from 90% down to 10% (See the following diagram.).

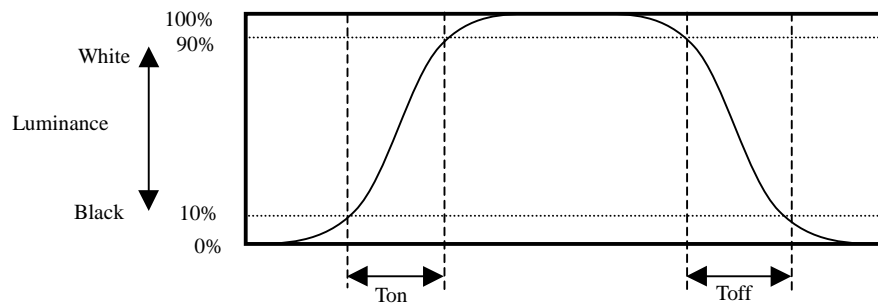

4.11.5 Definition of viewing angles

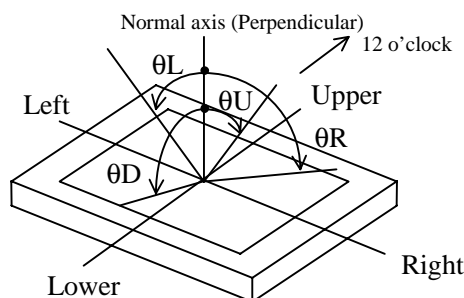

5. RELIABILITY TESTS

Test item	Condition	Judgment
High temperature and humidity (Operation)	① 60 ± 2°C, RH = 60%, 240hours ② Display data is white.	No display malfunctions Note1
Heat cycle (Operation)	① 0 ± 3°C...1hour 55 ± 3°C...1hour ② 50cycles, 4hours/cycle ③ Display data is white.	No display malfunctions Note1
Thermal shock (Non operation)	① -20 ± 3°C...30minutes 60 ± 3°C...30minutes ② 100cycles, 1hour/cycle ③ Temperature transition time is within 5 minutes.	No display malfunctions Note1
Vibration (Non operation)	① 5 to 100Hz, 11.76m/s <sup>2</sup> ② 1 minute/cycle ③ X, Y, Z direction ④ 10 times each directions	No display malfunctions Note1 No physical damages
Mechanical shock (Non operation)	① 294m/ s <sup>2</sup> , 11ms ② X, Y, Z direction ③ 3 times each directions	No display malfunctions Note1 No physical damages
ESD (Operation)	① 150pF, 150Ω, ±10kV ② 9 places on a panel surface Note2 ③ 10 times each places at 1 sec interval	No display malfunctions Note1
Dust (Operation)	① Sample dust: No.15 (by JIS-Z8901) ② 15 seconds stir ③ 8 times repeat at 1 hour interval	No display malfunctions Note1
Low pressure	operation ① 53.3 kPa ② 0°C±3°C...24 hours ③ +55°C±3°C...24 hours	No display malfunctions Note1
	non-operation ① 15 kPa ② -20°C±3°C...24 hours ③ +60°C±3°C...24 hours	

Note1: Display functions are checked under the same conditions as product inspection.

Note2: See the following figure for discharge points

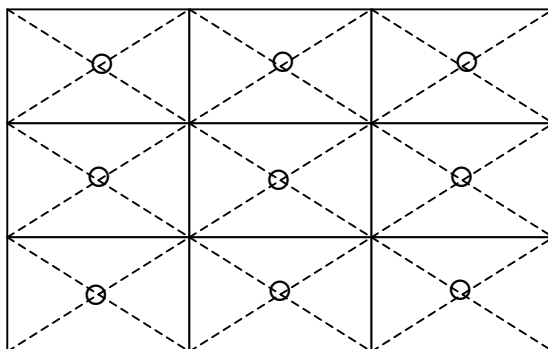



6. PRECAUTIONS

6.1 MEANING OF CAUTION SIGNS

The following caution signs have very important meaning. **Be sure to read "6.2 CAUTIONS" and "6.3 ATTENTIONS", after understanding this contents!**

	This sign has the meaning that customer will be injured by himself or the product will sustain a damage, if customer has wrong operations.
---	--

	This sign has the meaning that customer will get an electrical shock, if customer has wrong operations.
---	---

	This sign has the meaning that customer will be injured by himself, if customer has wrong operations.
---	---

6.2 CAUTIONS

	<b>* Do not touch HIGH VOLTAGE PART of the inverter while turn on. Customer will be in danger of an electric shock.</b>
---	---

	<b>* Do not touch the working backlight and IC. Customer will be in danger of burn injury. * Do not shock and press the LCD panel and the backlight! There is a danger of breaking, because they are made of glass. (Shock: To be not greater 294m/s<sup>2</sup> and to be not greater 11ms, Pressure: To be not greater 19.6N)</b>
---	---

6.3 ATTENTIONS 

6.3.1 Handling of the product

- ① Take hold of both ends without touch the circuit board cover when customer pulls out products (LCD modules) from inner packing box. If customer touches it, products may be broken down or out of adjustment, because of stress to mounting parts.
- ② Do not hook cables nor pull connection cables such as lamp cable and so on, for fear of damage.
- ③ If customer puts down the product temporarily, the product puts on flat subsoil as a display side turns down.
- ④ Take the measures of electrostatic discharge such as earth band, ionic shower and so on, when customer deals with the product, because products may be damaged by electrostatic.
- ⑤ The torque for mounting screws must never exceed TBD N·m. Higher torque values might result in distortion of the bezel.
- ⑥ The product must be installed using mounting holes without undue stress such as bends or twist (See outline drawings). And do not add undue stress to any portion (such as bezel flat area) except mounting hole portion.  
Bends or twist described above and undue stress to any portion except mounting hole portion may cause display un-uniformity.
- ⑦ Do not press or rub on the sensitive display surface. If customer clean on the panel surface, NEC Corporation recommends using the cloth with ethanolic liquid such as screen cleaner for LCD.
- ⑧ Do not push-pull the interface connectors while the product is working, because wrong power sequence may break down the product.



- ⑨ Do not bend or unbend the lamp cable at the near part of the lamp holding rubber, to avoid the damage for high voltage side of the lamp. This damage may cause a lamp breaking and abnormal operation of high voltage circuit.

6.3.2 Environment

- ① Do not operate or store in high temperature, high humidity, dewdrop atmosphere or corrosive gases. Keep the product in antistatic pouch in room temperature, because of avoidance for dusts and sunlight, if customer stores the product.
- ② In order to prevent dew condensation occurring by temperature difference, the product packing box must be opened after leave under the environment of an unpacking room temperature enough. Because a situation of dew condensation occurring is changed by the environmental temperature and humidity, evaluate the leaving time sufficiently. (Recommendation leaving time: 6 hour or more with packing state)
- ③ Do not operate in high magnetic field. Circuit boards may be broken down by it.
- ④ Use an original protection sheet on the product surface (polarizer). Adhesive type protection sheet should be avoided, because it may change color or properties of the polarizer.

6.3.3 Characteristics

**The following items are neither defects nor failures.**

- ① Response time, luminance and color may be changed by ambient temperature.
- ② The LCD may be seemed luminance non-uniformity, flicker, vertical seam or small spot by display patterns.
- ③ Optical characteristics (e.g. luminance, display uniformity, etc.) gradually is going to change depending on operating time, and especially low temperature, because the LCD has cold cathode fluorescent lamps.
- ④ Do not display the fixed pattern for a long time because it may cause image sticking. Use a screen saver, if the fixed pattern is displayed on the screen.
- ⑤ The display color may be changed by viewing angle because of the use of condenser sheet in the backlight.
- ⑥ Optical characteristics may be changed by input signal timings.
- ⑦ The interference noise of input signal frequency for this product's signal processing board and luminance control frequency of customer's backlight inverter may appear on a display. Set up luminance control frequency of backlight inverter so that the interference noise does not appear.
- ⑧ The product may be changed of luminance by voltage variation, even if power source applies recommended voltage to backlight inverter.
- ⑨ Optical characteristics may be changed by input signal timings.

6.3.4 Other

- ① All GND, backlight inverter ground (GNDB), VDD and backlight inverter power supply voltage (VDDDB) terminals should be used without a non-connected line.
- ② Do not disassemble a product or adjust volume without permission of NEC Corporation.
- ③ See "REPLACEMENT MANUAL FOR BACKLIGHT UNIT", if customer would like to replace backlight lamps.
- ④ Pay attention not to insert waste materials inside of products, if customer uses screwdrivers.
- ⑤ Pack the product with original shipping package, because of avoidance of some damages during transportation, when customer returns it to NEC Corporation for repair and so on.
- ⑥ Not only the module but also the equipment that used the module should be packed and transported as the module becomes vertical. Otherwise, there is the fear that a display dignity decreases by an impact or vibrations."

7. OUTLINE DRAWINGS

7.1 FRONT VIEW

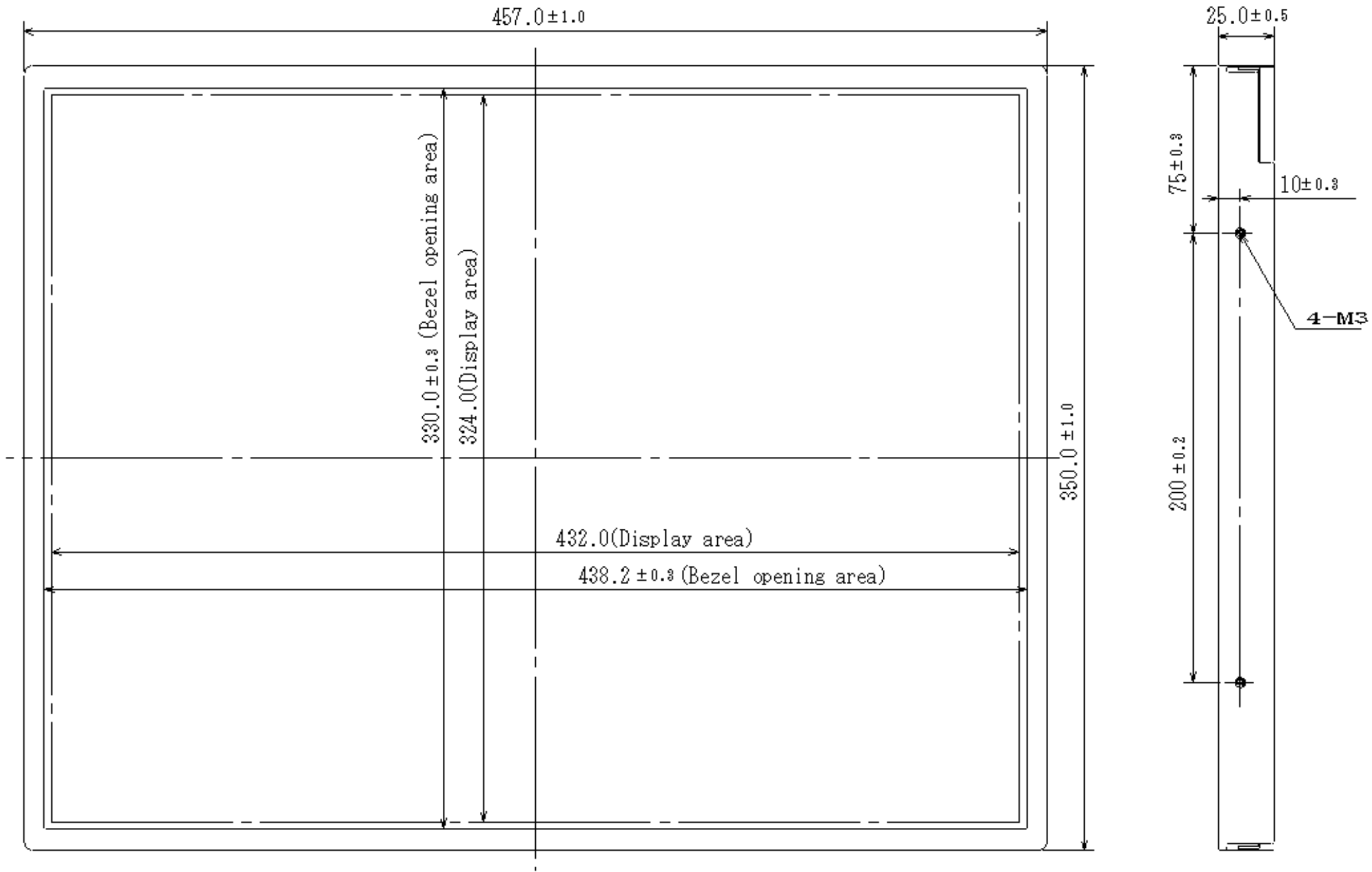

- Note1: Not shown tolerances of the dimensions are  $\pm 0.5$ mm.
- Note2: The dimensions in parenthesis are for reference.
- Note3: The torque for mounting screw should never exceed TBD N·m.
- Note4: The right side and left side are symmetric figure for vertical axis.

Unit: mm

7.2 REAR VIEW

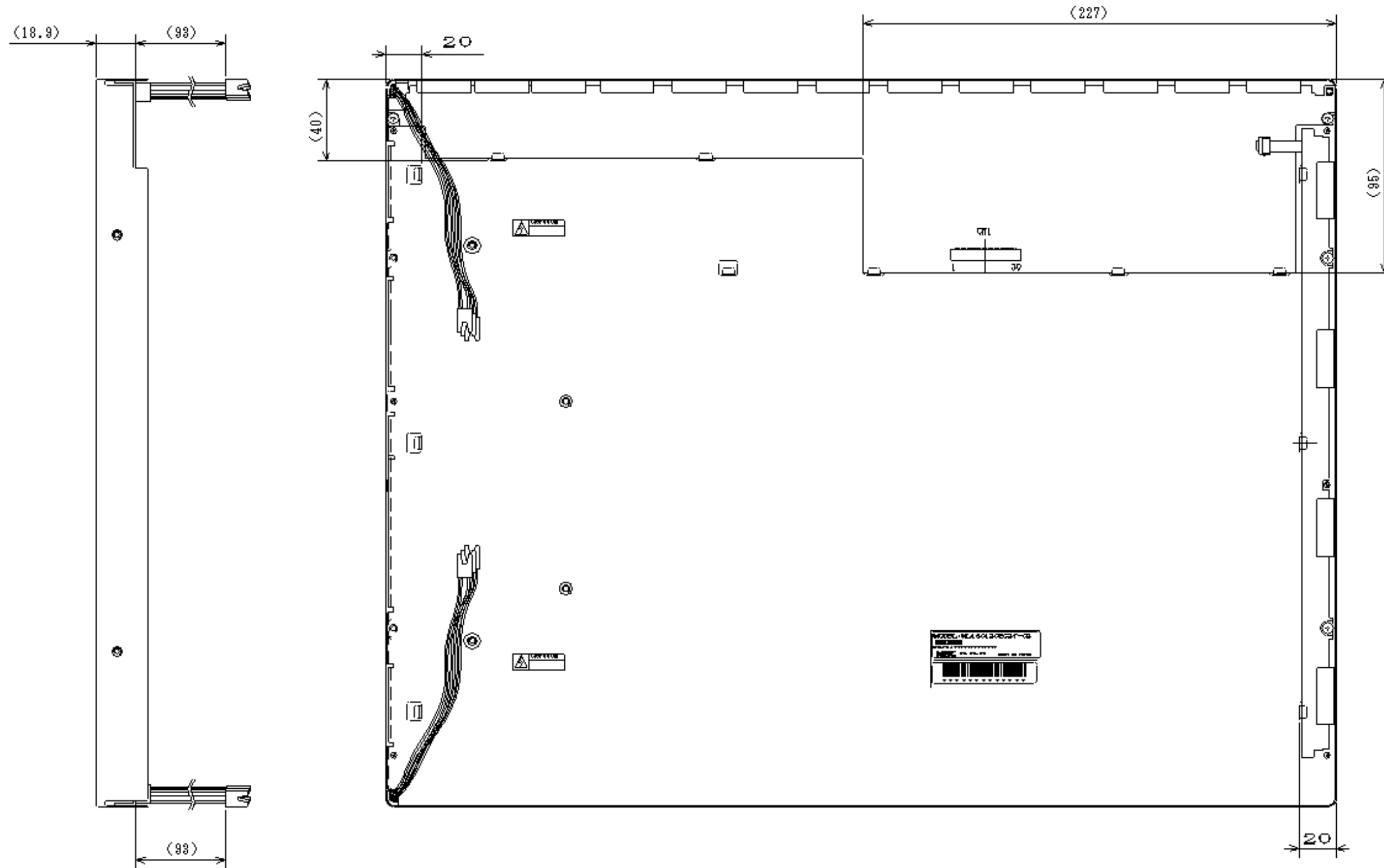



Note1: Not shown tolerances of the dimensions are  $\pm 0.5$ mm.  
 Note2: The dimensions in parenthesis are for reference.  
 Note3: The torque for mounting screw should never exceed TBD N·m.

Unit: mm

**REVISION HISTORY**

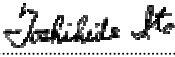
*The inside of latest specifications is revised to the clerical error and the major improvement of previous edition. Only a changed part such as functions, characteristic value and so on that may affect a design of customers, are described especially below.*

Edition	Document number	Prepared date	Revision contents and signature
1st edition	DOD-M-1313	Feb. 3, 2003	<p><b>Revision contents</b></p> <p>New issue</p> <p><b>Signature of writer</b></p> <p><i>Approved by</i>                      <i>Checked by</i>                      <i>Prepared by</i></p> <p>                      _____                      </p> <p>_____                      _____                      _____</p> <p>T. ITO                      _____                      R. KAWASHIMA</p>