

# OKI semiconductor

## MSM82C43RS/GS

### INPUT/OUTPUT PORT EXPANDER

#### GENERAL DESCRIPTION

The MSM82C43 is an input/output port expander device based on  $3\mu$  silicon gate CMOS technology and designed to operate at low power consumption levels.

In systems employing the MSM80C48/49 8-bit 1-chip microcomputers, 4-bit data can be expanded by dividing between four I/O lines by executing the MOVDPp, A, MOVDA; Pp, ANLDPp, A and ORLDPp, A instructions.

#### FEATURES

- $3\mu$  silicon gate CMOS technology for low power consumption
- 2.5 to 6 V single power supply (dependent on MSM80C 48/49 operating frequency.)
- Fully static operation
- Bidirectional I/O ports
- TTL compatible (ports 4 thru 7)
- Functional compatibility with Intel i8243
- 24 pin Plastic DIP (DIP24-P-800)
- 24 pin Plastic SOP (SOP24-P-430-K)
- 24 pin-V Plastic SOP (SOP24-P-430-VK)

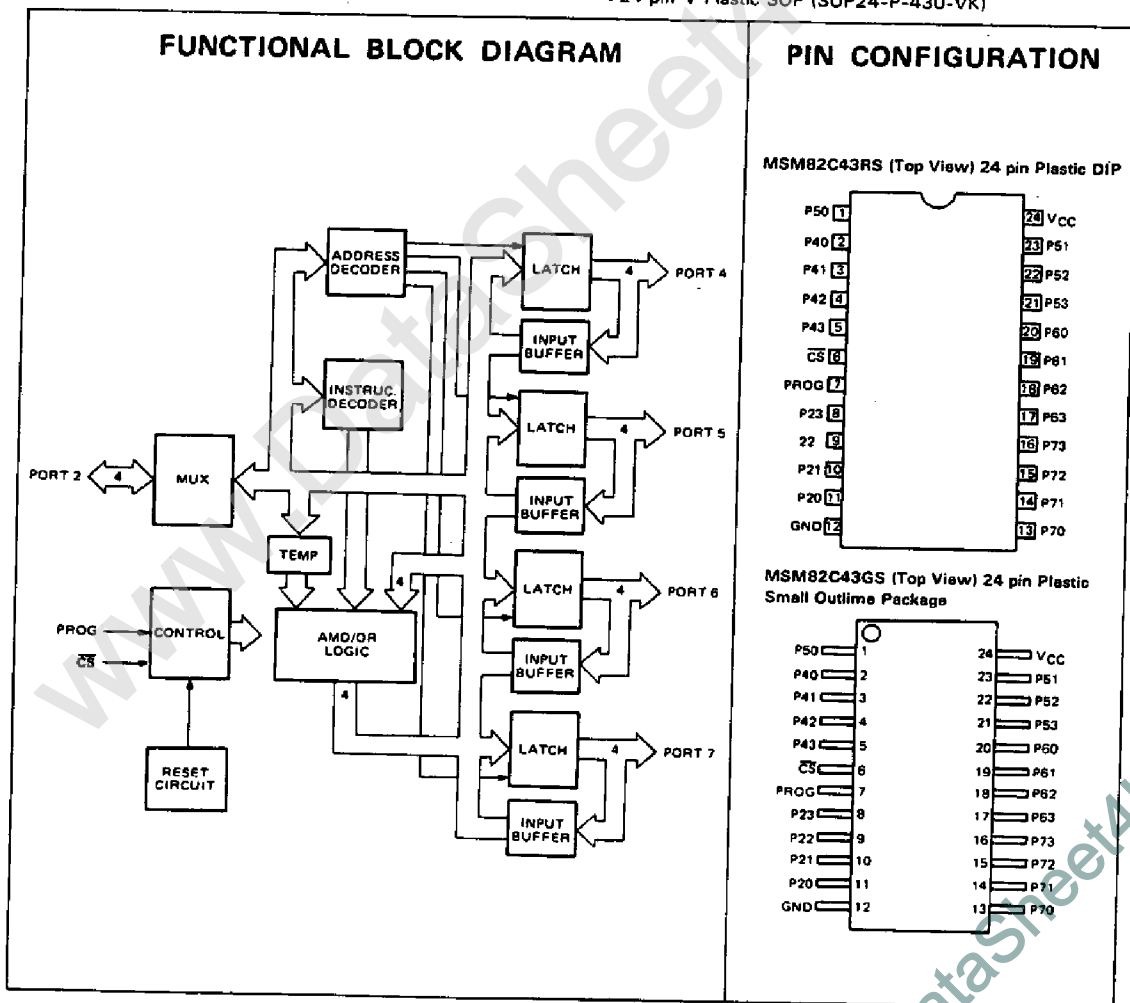

## ELECTRIC CHARACTERISTICS

### ● Absolute Maximum Ratings

Parameter	Symbol	Conditions	Rating	Unit
Supply Voltage	V <sub>CC</sub>	T <sub>a</sub> = 25°C	-0.5 ~ 7	V
Input Voltage	V <sub>I</sub>	T <sub>a</sub> = 25°C	-0.3 ~ V <sub>CC</sub>	V
Storage Temperature	T <sub>stg</sub>	—	-65 ~ +150	°C

### ● Operating Conditions

Parameter	Symbol	Conditions	Rating	Unit
Supply Voltage	V <sub>CC</sub>	—	2.5 ~ 6 <sup>*1</sup>	V
Ambient Temperature	T <sub>A</sub>	—	-40 ~ +85	°C
Fan-out	N	MOS load	10	—
		TTL load	3 <sup>*2</sup>	—

### ● DC Characteristics

(V<sub>CC</sub> = 4.0V ~ 6.0V, T<sub>a</sub> = -40°C ~ +85°C)

Parameter	Symbol	Conditions	MIN	TYP	MAX	Unit
"L" Input Voltage	V <sub>IL</sub>		-0.5	—	0.13V <sub>CC</sub>	V
					V	
"H" Input Voltage	V <sub>IH</sub>		0.4V <sub>CC</sub>	—	V <sub>CC</sub>	V
					V	
"L" Output Voltage Ports 4-7	V <sub>OL1</sub>	I <sub>OL</sub> = 5mA	—	—	0.45	V
"L" Output Voltage Port 7	V <sub>OL2</sub>	I <sub>OL</sub> = 20mA	—	—	1	V
"L" Output Voltage Port 2	V <sub>OL3</sub>	I <sub>OL</sub> = 0.9mA	—	—	0.45	V
"L" Total Output Current from Ports 4-7 <sup>*3</sup>	I <sub>OL</sub>	5mA/1PIN	—	—	80	mA
"H" Output Voltage Ports 4-7	V <sub>OH1</sub>	I <sub>OH</sub> = -240μA	0.75V <sub>CC</sub>	—	—	V
"H" Output Voltage Port 2	V <sub>OH2</sub>	I <sub>OH</sub> = -100μA	0.75V <sub>CC</sub>	—	—	V
"H" Output Voltage Ports 4-7	V <sub>OH1</sub>	I <sub>OH</sub> = -40μA	0.93V <sub>CC</sub>	—	—	V
"H" Output Voltage Port 2	V <sub>OH2</sub>	I <sub>OH</sub> = -20μA	0.93V <sub>CC</sub>	—	—	V
Input Leak Current <sup>*3</sup>	I <sub>IL1</sub>	0 ≤ V <sub>IN</sub> ≤ V <sub>CC</sub>	-10	—	20	μA
Input Leak Current <sup>*6</sup>	I <sub>IL2</sub>	0 ≤ V <sub>IN</sub> ≤ V <sub>CC</sub>	-10	—	10	μA
Power Supply Current	I <sub>CC</sub>	Standby stop No accessing	—	5	100	μA
		For continuous MSM80C49 access- ing at 11 MHz	—	1	2	mA

- NOTE: \*1 The supply voltage during operation is dependent on MSM80C49 operating frequency.  
 \*2 Except P20 thru P23.  
 \*3 P40 thru P43, P50 thru P53, P60 thru P63, P70 thru P73.  
 \*4 P70 thru P73.  
 \*5 P20 thru P23.  
 \*6 P20 thru P23, CS, PROG.

● AC Characteristics

(V<sub>CC</sub> = 4.0V ~ 6.0V, T<sub>a</sub> = -40°C ~ +85°C)

Parameter	Symbol	Conditions	MIN	MAX	Unit
Port Control Setting Time (up to PROG Falling Edge)	t <sub>A</sub>	80pF LOAD	50	—	ns
Port Control Holding Time (From PROG Falling Edge)	t <sub>B</sub>	20pF LOAD	60	—	ns
Output Data Setting Time	t <sub>C</sub>	80pF LOAD	200	—	ns
Output Data Holding Time	t <sub>D</sub>	20pF LOAD	20	—	ns
Input Data Holding Time	t <sub>H</sub>	20pF LOAD	0	150	ns
PROG Pulse Width	t <sub>K</sub>	—	700	—	ns
$\overline{CS}$ Valid Time (before and after PROG)	t <sub>CS</sub>	—	50	—	ns
Output Data Valid Time (at Ports 4-7)	t <sub>PO</sub>	100pF LOAD	—	700	ns
Input Data Holding Time (at Ports 4-7)	t <sub>LP1</sub>	—	100	—	ns
Input Data Valid Time (from PROG Falling Edge)	t <sub>ACC</sub>	80pF LOAD	—	650	ns

**TIMING CHART**

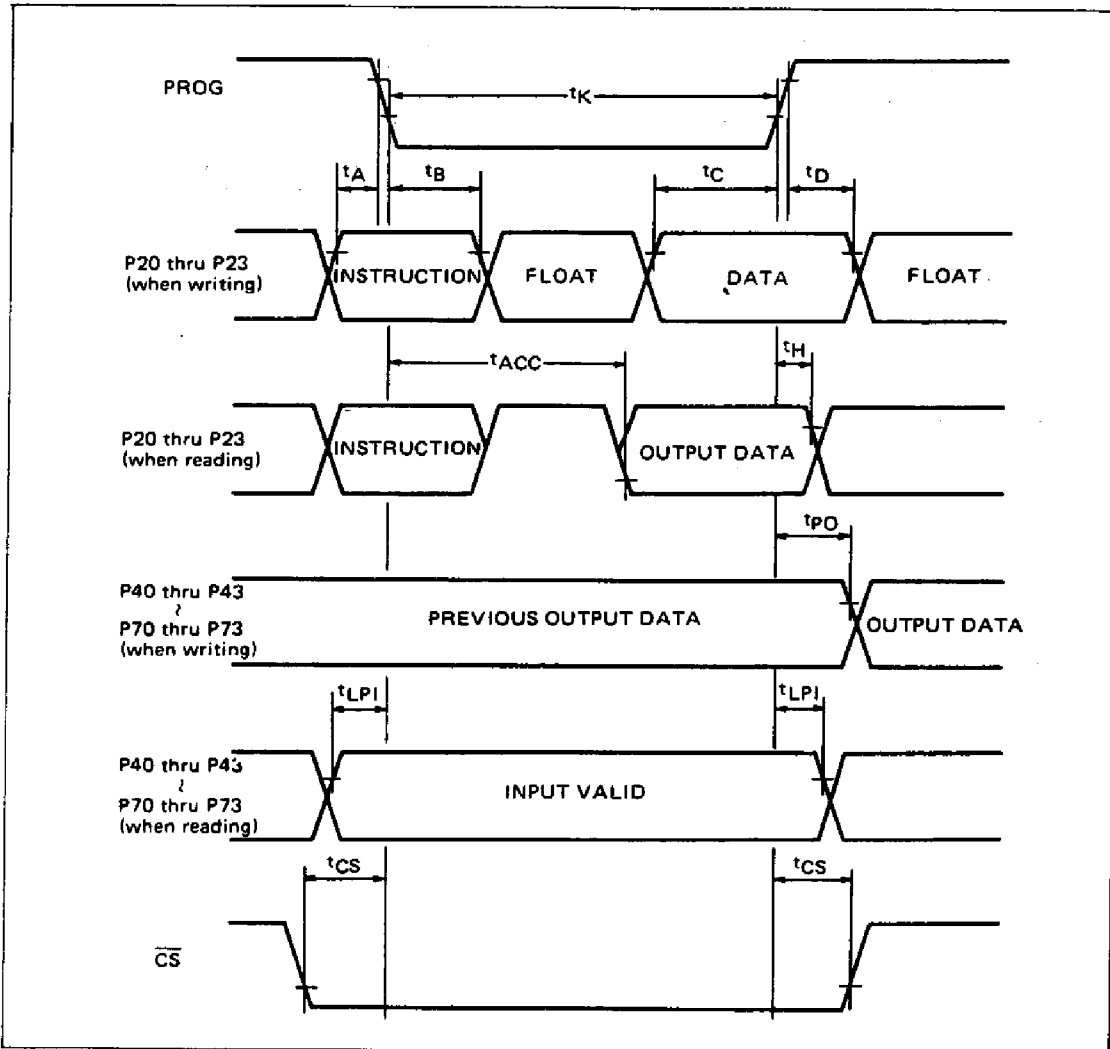

### PIN FUNCTIONS

Pin	Function
PROG	Clock input from MSM80C49. When PROG is changed from "H" to "L", MSM82C43 STARTS operating in accordance with an order from MSM80C49.
$\overline{CS}$	Input for chip select. Outputs and internal status cannot be changed when $\overline{CS}$ is "H".
P20 - P23	4-bit bidirectional I/O ports. When connected to P20 thru P23 of MSM80C49, direct data transfer from port to accumulator and from accumulator to port is possible.
P40 - P43 P50 - P53 P60 - P63 P70 - P73	4-bit bidirectional I/O ports. Data is latched statistically when output to ports, but is only valid while PROG is at "L" level when input.
VCC	+5V power supply
GND	GROUND

### FUNCTIONS

● **Write mode**

Execution of MOVDp, A, ORLDp, A, ANLDp, and A by MSM80C49 enables direct output of accumulator contents to ports 4 thru 7, and output to the ports after ORing or ANDing with port data. The port data is latched statistically at this time and remains unchanged until execution of the next instruction.

level. When at "H" level, ports 4 thru 7 are switched to tristate and port 2 is switched to input mode.

● **Address and instruction code**

Instruction	P23	P22	Port	P21	P20
Read	0	0	Port 4	0	0
Write	0	1	Port 5	0	1
OR	1	0	Port 6	1	0
AND	1	1	Port 7	1	1

● **Read mode**

Execution of MOVDA and Pp results in data of ports 4 thru 7 being accepted by the accumulator. Note that port data is valid only while PROG is at "L"

● **MSM82C43 Multiple connection example**

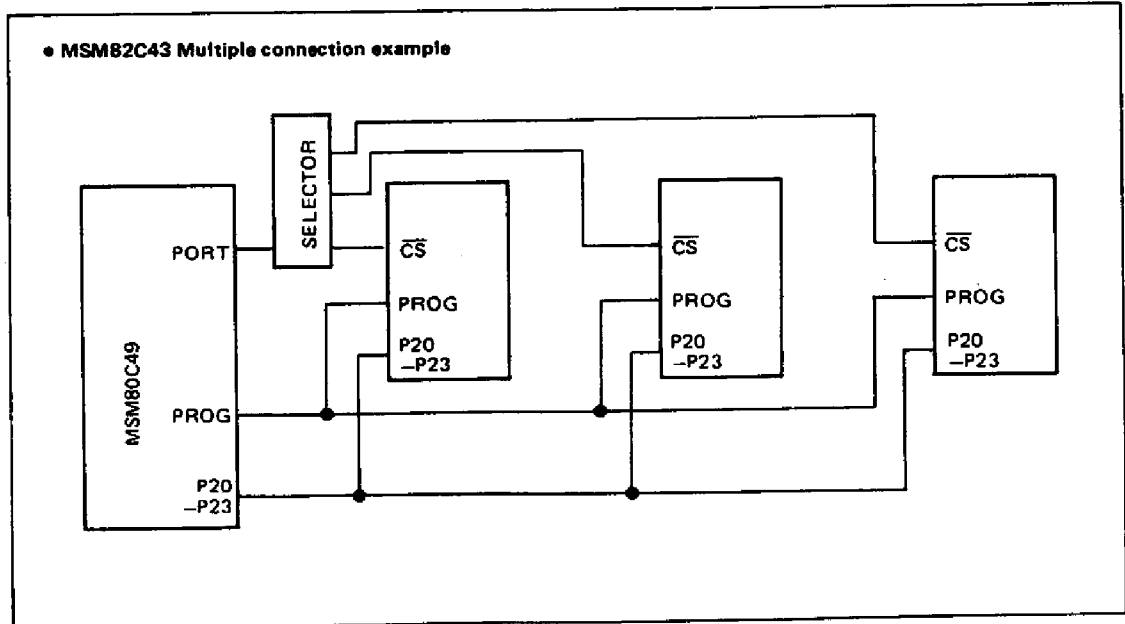

## OUTPUT CHARACTERISTICS

• Standard DC characteristics

Output "H" voltage ( $V_{OH}$ ) vs. output current ( $I_{OH}$ )

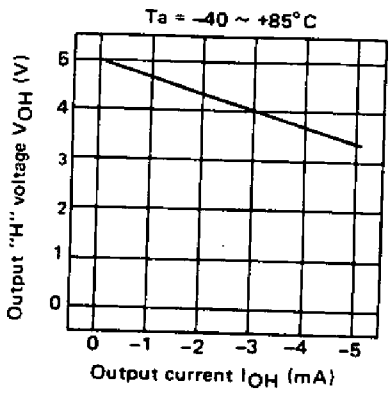

• Standard AC characteristics

$t_{PO}$ ,  $t_H$ , and  $t_{ACC}$  vs. power supply voltage ( $V_{CC}$ )

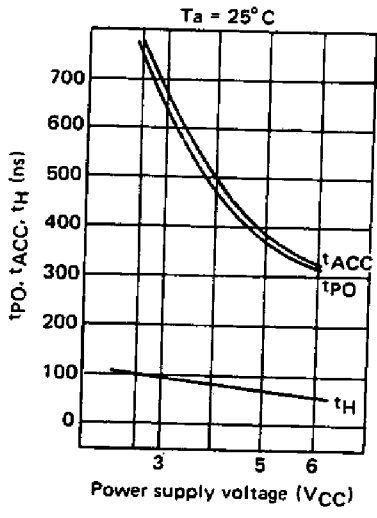

Output "L" voltage ( $V_{OL}$ ) vs. output current ( $I_{OL}$ )

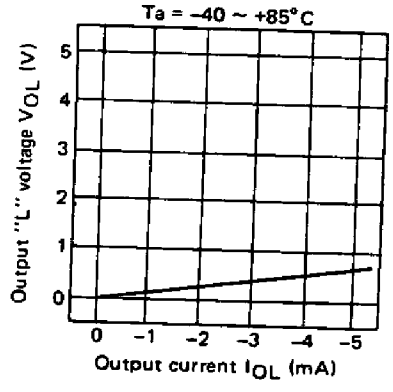

Operating frequency vs. power supply voltage ( $I_{CC}$ )

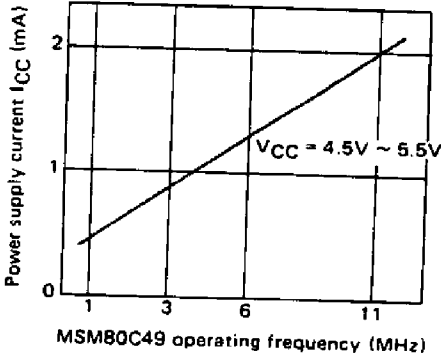

Note: The direction which the output current flows through the device is taken as the positive direction.

### GUARANTEED MSM82C43 OPERATING RANGE

