

N-CHANNEL MOS FET
FOR SWITCHING

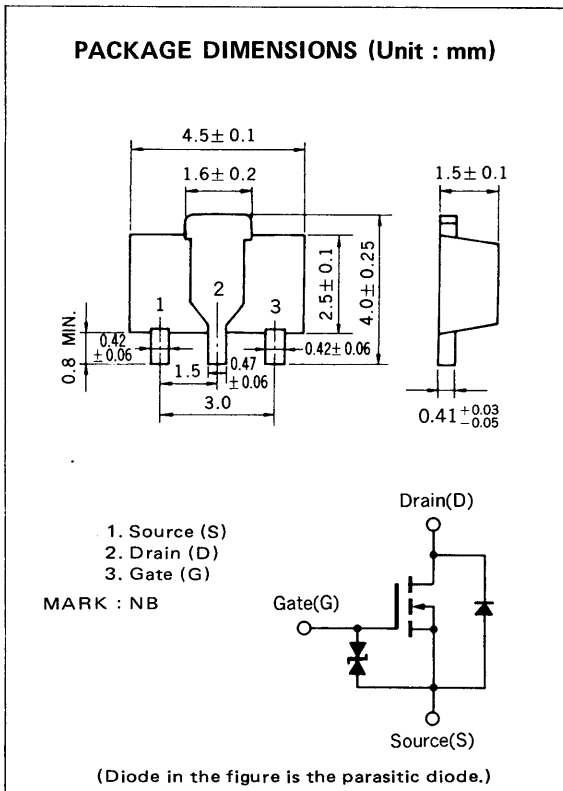

The 2SK1483 is an N-channel vertical type MOS FET switching device which can be directly driven from an IC operating with a 5 V single power supply. The device features low ON-state resistance and outstanding switching characteristics and thus is ideal for driving actuators such as motors, solenoids, and relays.

FEATURES

- Can be driven directly from an IC operating with a 5 V single power supply.
- Low ON-state resistance
 $R_{DS(on)} = 0.8 \Omega$ MAX. at $V_{GS} = 4 V, I_D = 0.5 A$
 $R_{DS(on)} = 0.4 \Omega$ MAX. at $V_{GS} = 10 V, I_D = 0.5 A$
- Can be used complementary with the 2SJ197.

QUALITY GRADE

Standard

Please refer to "Quality grade on NEC Semiconductor Devices" (Document number IEI-1209) published by NEC Corporation to know the specification of quality grade on the devices and its recommended applications.

ABSOLUTE MAXIMUM RATINGS ($T_a = 25^\circ C$)

PARAMETER	SYMBOL	RATING	UNIT	TEST CONDITIONS
Drain to Source Voltage	V_{DSS}	30	V	$V_{GS} = 0$
Gate to Source Voltage	V_{GSS}	±20	V	$V_{DS} = 0$
Drain Current (DC)	$I_D(DC)$	±2.0	A	
Drain Current (pulse)	$I_D(pulse)$	±4.0	A	$PW \leq 10 ms, Duty Cycle \leq 50 \%$
Total Power Dissipation	P_T	2.0	W	when using ceramic board of $16 cm^2 \times 0.7 mm$
Channel Temperature	T_{ch}	150	°C	
Storage Temperature	T_{stg}	-55 to +150	°C	

ELECTRICAL CHARACTERISTICS (T_a = 25 °C)

PARAMETER	SYMBOL	MIN.	TYP.	MAX.	UNIT	TEST CONDITIONS
Drain Leakage Current	I _{DSS}			10	μA	V _{DS} = 30 V, V _{GS} = 0
Gate Leakage Current	I _{GSS}			±10	μA	V _{GS} = ±20 V, V _{DS} = 0
Gate Cutoff Voltage	V _{GS(off)}	1.3	1.8	2.5	V	V _{DS} = 10 V, I _D = 1 mA
Forward Transfer Admittance	y _{fs}	0.4			S	V _{DS} = 10 V, I _D = 0.5 A
Drain to Source On-State Resistance 1	R _{DS(on)1}		0.19	0.8	Ω	V _{GS} = 4.0 V, I _D = 0.5 A
Drain to Source On-State Resistance 2	R _{DS(on)2}		0.15	0.4	Ω	V _{GS} = 10 V, I _D = 0.5 A
Input Capacitance	C _{iss}		230		pF	V _{DS} = 10 V, V _{GS} = 0, f = 1.0 MHz
Output Capacitance	C _{oss}		170		pF	
Feedback Capacitance	C _{rss}		45		pF	
On-State Delay Time	t _{d(on)}		15		ns	V _{GS(on)} = 10 V, R _G = 10 Ω V _{DD} = 25 V, I _D = 0.5 A R _L = 50 Ω
Rise Time	t _r		50		ns	
Off-State Delay Time	t _{d(off)}		420		ns	
Fall Time	t _f		240		ns	

SWITCHING TIME MEASUREMENT CIRCUIT & MEASUREMENT CONDITIONS

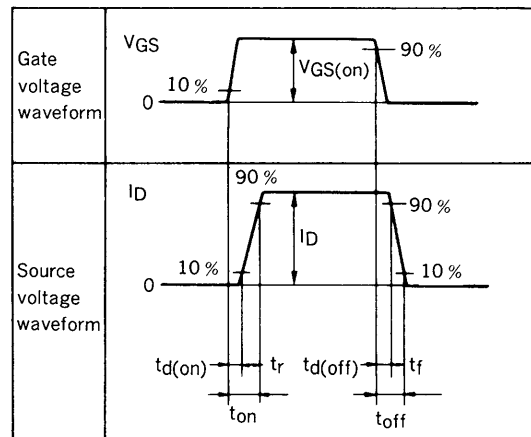
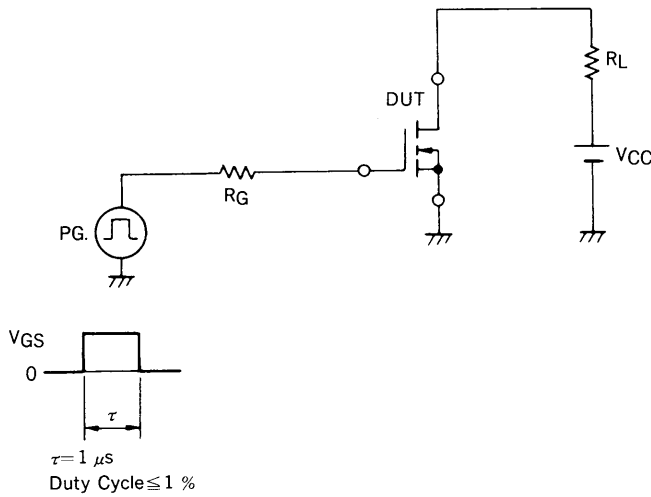

CHARACTERISTIC CURVES ($T_a = 25^\circ\text{C}$)

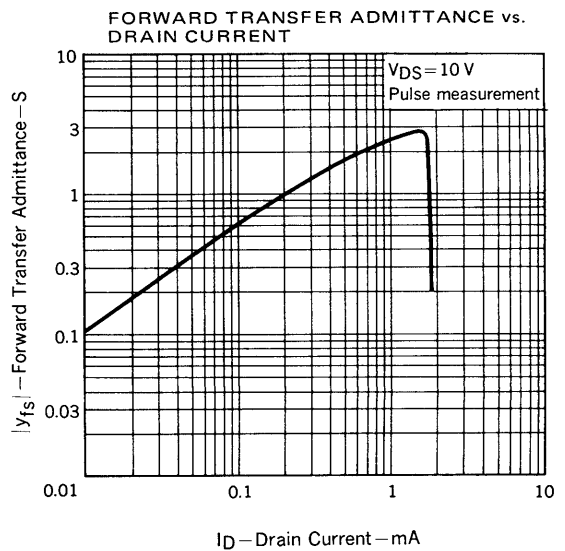
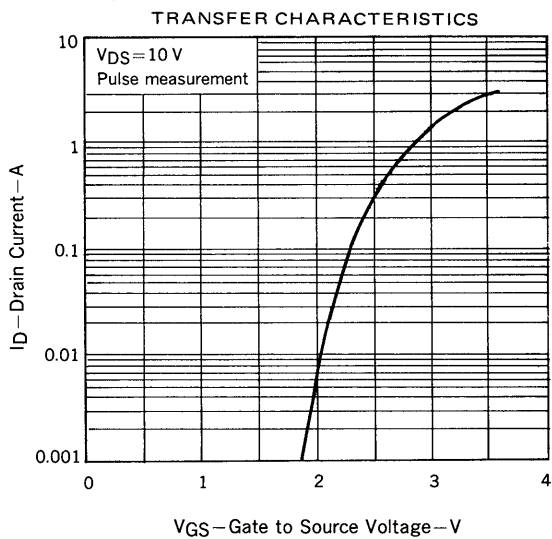
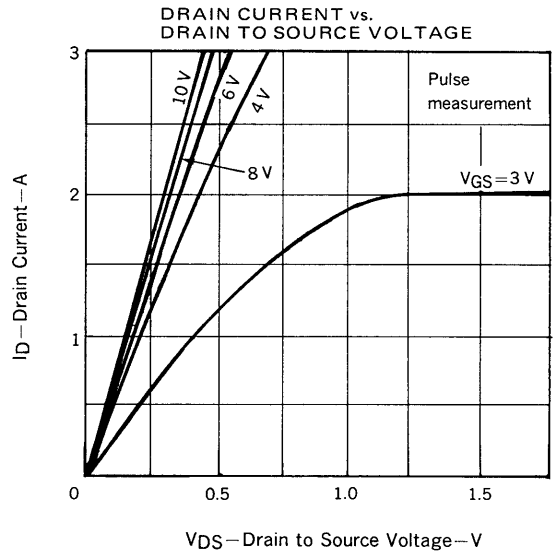
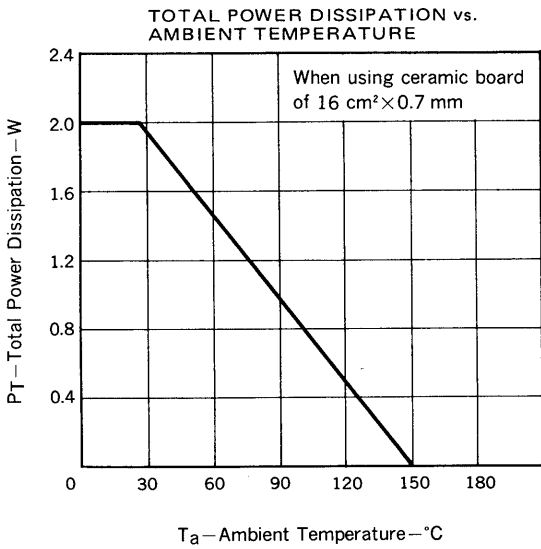
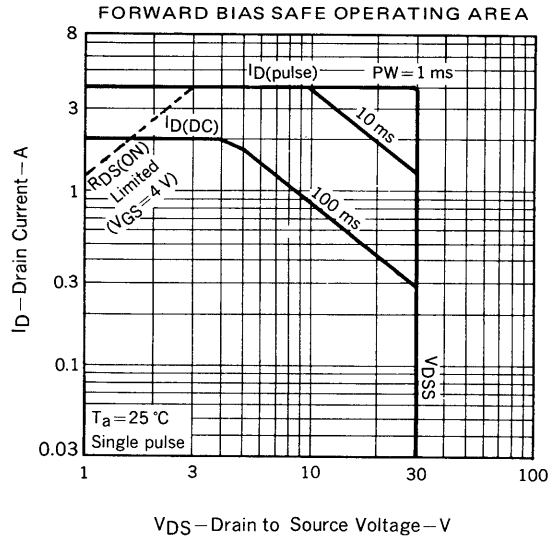
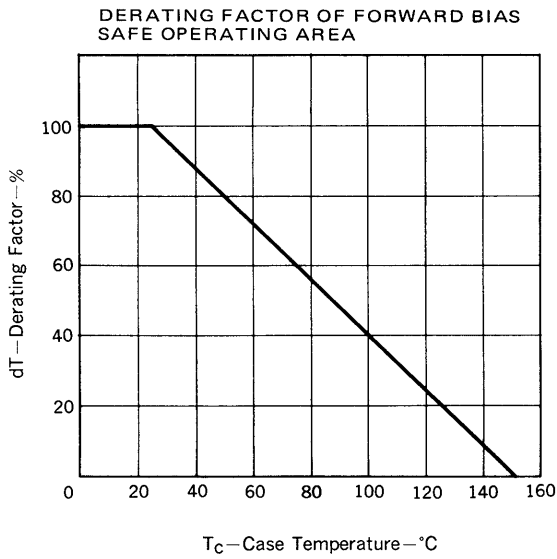

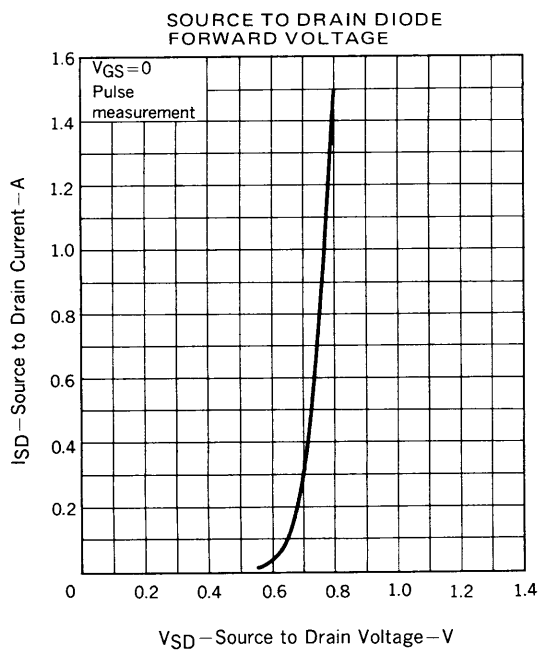
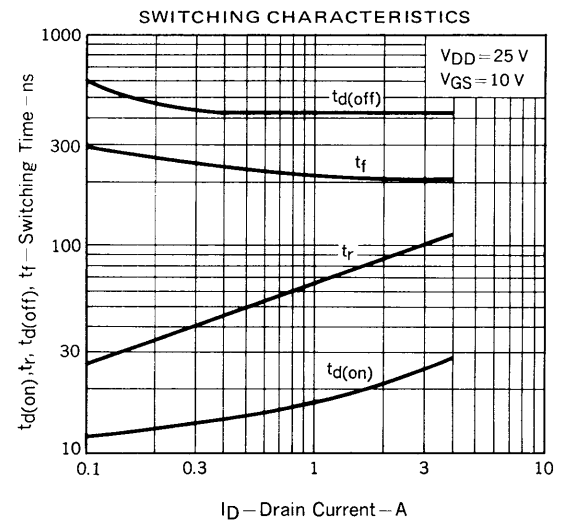
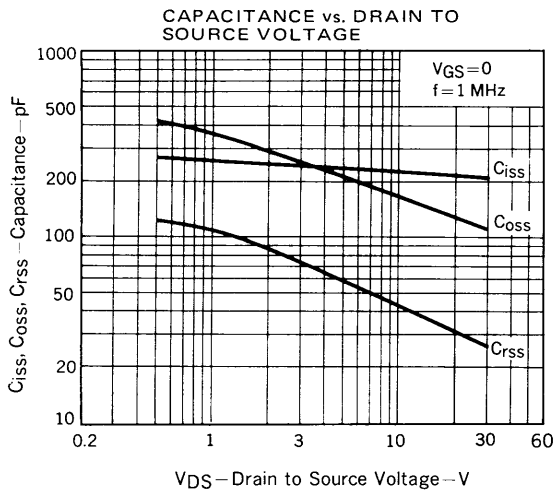
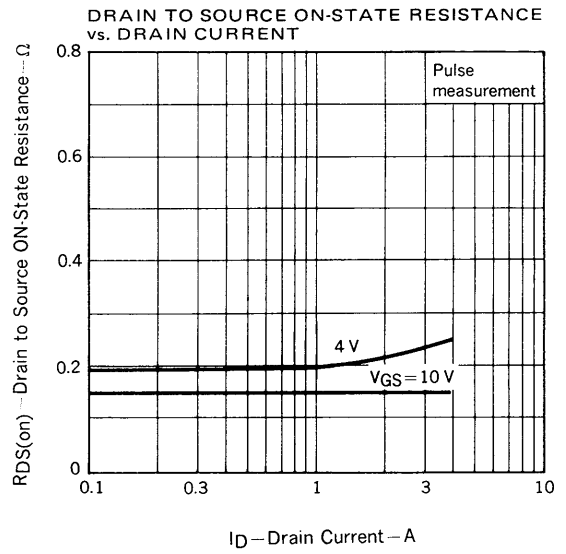
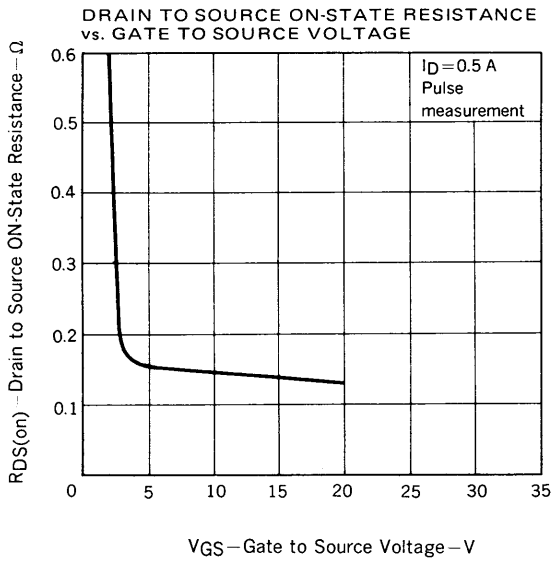

RECOMMENDED SOLDERING CONDITIONS

Solder this product under the following recommended conditions.

For soldering methods or soldering conditions other than those recommended in the table, please consult our NEC salespeople.

SURFACE MOUNT TYPE

For details of the soldering conditions, refer to the surface-mount type Device Packaging Manual (IEI-1207).

Soldering method	Soldering conditions	Recommended condition code
Infrared reflow	Package peak temperature: 230 °C , Soldering time: 30 sec max. (at 210 °C min.) No. of applied times: Once Limit on No. of days*: None	IR30-00
VPS	Package peak temperature: 215 °C Soldering time: 40 sec max. (at 200 °C min.) No. of applied times: Once Limit on No. of days*: None	VP15-00
Wave soldering	Solder bath temperature: 260 °C max. Soldering time: 10 sec max. No. of applied times: Once Limit on No. of days*: None	WS60-00

*: Refers to the number of days to be kept in storage after unsealing the dry pack. The storage conditions are 25 °C and 65 % RH.

Note: Do not use any two of the above soldering methods in combination.

REFERENCE

Document Name	Document No.
NEC semiconductor device reliability/quality control system.	TEI-1202
Quality grade on NEC semiconductor devices.	IEI-1209
Semiconductor device mounting technology manual.	IEI-1207
Semiconductor device package manual.	IEI-1213
Guide to quality assurance for semiconductor devices.	MEI-1202
Semiconductor selection guide.	MF-1134

[MEMO]

No part of this document may be copied or reproduced in any form or by any means without the prior written consent of NEC Corporation. NEC Corporation assumes no responsibility for any errors which may appear in this document.

NEC Corporation does not assume any liability for infringement of patents, copyrights or other intellectual property rights of third parties by or arising from use of a device described herein or any other liability arising from use of such device. No license, either express, implied or otherwise, is granted under any patents, copyrights or other intellectual property rights of NEC Corporation or others.

The devices listed in this document are not suitable for use in aerospace equipment, submarine cables, nuclear reactor control systems and life support systems. If customers intend to use NEC devices for above applications or they intend to use "Standard" quality grade NEC devices for applications not intended by NEC, please contact our sales people in advance.

Application examples recommended by NEC Corporation

Standard: Computer, Office equipment, Communication equipment, Test and Measurement equipment, Machine tools, Industrial robots, Audio and Visual equipment, Other consumer products, etc.

Special: Automotive and Transportation equipment, Traffic control systems, Antidisaster systems, Anticrime systems, etc.

This datasheet has been download from:

www.datasheetcatalog.com

Datasheets for electronics components.