

# Low Noise, Rail-to-Rail Precision Op Amp

February 2000

## FEATURES

- Rail-to-Rail Input and Output
- 100% Tested Low Voltage Noise:  
 $3.2\text{nV}/\sqrt{\text{Hz}}$  Typ at 1kHz  
 $4.5\text{nV}/\sqrt{\text{Hz}}$  Max at 1kHz
- Offset Voltage:  $60\mu\text{V}$  Max
- Low  $V_{OS}$  Drift:  $0.2\mu\text{V}/^\circ\text{C}$  Typ
- Low Input Bias Current: 20nA Max
- Wide Supply Range: 3V to  $\pm 15\text{V}$
- High  $A_{VOL}$ :  $4\text{V}/\mu\text{V}$  Min,  $R_L = 1\text{k}$
- High CMRR: 109dB Min
- High PSRR: 108dB Min
- Gain Bandwidth Product: 7.2MHz
- Slew Rate:  $2.5\text{V}/\mu\text{s}$
- Operating Temperature Range:  $-40^\circ\text{C}$  to  $85^\circ\text{C}$

## APPLICATIONS

- Low Noise Signal Processing
- Microvolt Accuracy Threshold Detection
- Strain Gauge Amplifiers
- Tape Head Preamplifiers
- Direct Coupled Audio Gain Stages
- Infrared Detectors

## DESCRIPTION

The LT<sup>®</sup>1677 features the lowest noise performance available for a rail-to-rail operational amplifier:  $3.2\text{nV}/\sqrt{\text{Hz}}$  wideband noise, 1/f corner frequency of 13Hz and 70nV peak-to-peak 0.1Hz to 10Hz noise. Low noise is combined with outstanding precision:  $20\mu\text{V}$  offset voltage and  $0.2\mu\text{V}/^\circ\text{C}$  drift, 130dB common mode and power supply rejection and 7.2MHz gain bandwidth product. The common mode range exceeds the power supply by 100mV.

The voltage gain of the LT1677 is extremely high, especially with a single supply: 20 million driving a 1k load.

In the design, processing and testing of the device, particular attention has been paid to the optimization of the entire distribution of several key parameters. Consequently, the specifications of even the lowest cost grade have been spectacularly improved compared to competing rail-to-rail amplifiers.

 LTC and LT are registered trademarks of Linear Technology Corporation.

## TYPICAL APPLICATION

### Precision High Side Current Sense

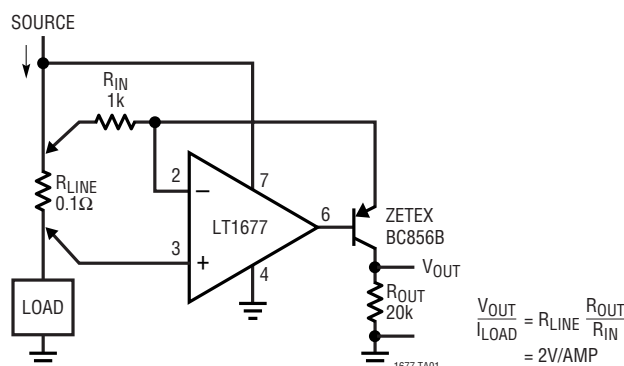

**ABSOLUTE MAXIMUM RATINGS** (Note 1)

Supply Voltage .....	±22V	Operating Temperature Range	
Input Voltages (Note 2) .....	0.3V Beyond Either Rail	LT1677C (Note 4) .....	-40°C to 85°C
Differential Input Current (Note 2) .....	±25mA	LT1677I .....	-40°C to 85°C
Output Short-Circuit Duration (Note 3) .....	Indefinite	Specified Temperature Range	
Storage Temperature Range .....	-65°C to 150°C	LT1677C (Note 5) .....	-40°C to 85°C
Lead Temperature (Soldering, 10 sec.) .....	300°C	LT1677I .....	-40°C to 85°C

**PACKAGE/ORDER INFORMATION**

	ORDER PART NUMBER		ORDER PART NUMBER
	LT1677CN8 LT1677IN8		LT1677CS8 LT1677IS8
			S8 PART MARKING
			1677 1677I

Consult factory for Military grade parts.

**ELECTRICAL CHARACTERISTICS**  $T_A = 25^\circ\text{C}$ ,  $V_S = \pm 15\text{V}$ ,  $V_{CM} = V_O = 0\text{V}$  unless otherwise noted.

SYMBOL	PARAMETER	CONDITIONS (Note 6)	MIN	TYP	MAX	UNITS
$V_{OS}$	Input Offset Voltage	$V_{CM} = 14\text{V to } 15.1\text{V}$		20	60	$\mu\text{V}$
		$V_{CM} = -13.3\text{V to } -15.1\text{V}$		150	400	$\mu\text{V}$
				1.5	5	mV
$\frac{\Delta V_{OS}}{\Delta \text{Time}}$	Long Term Input Voltage Stability			0.3		$\mu\text{V/Mo}$
$I_B$	Input Bias Current	$V_{CM} = 14\text{V to } 15.1\text{V}$		±2	±20	nA
		$V_{CM} = -13.3\text{V to } -15.1\text{V}$		0.16	0.4	$\mu\text{A}$
			-1.5	-0.4		$\mu\text{A}$
$I_{OS}$	Input Offset Current	$V_{CM} = 14\text{V to } 15.1\text{V}$		3	15	nA
		$V_{CM} = -13.3\text{V to } -15.1\text{V}$		5	25	nA
				20	200	nA
$e_n$	Input Noise Voltage	0.1Hz to 10Hz (Note 7)		70		nV <sub>p-p</sub>
		$V_{CM} = 15\text{V}$		33		nV <sub>p-p</sub>
		$V_{CM} = -15\text{V}$		100		nV <sub>p-p</sub>
	Input Noise Voltage Density	$V_{CM} = 0\text{V}$ , $f_0 = 10\text{Hz}$		5.2		nV/ $\sqrt{\text{Hz}}$
		$V_{CM} = 15\text{V}$ , $f_0 = 10\text{Hz}$		25		nV/ $\sqrt{\text{Hz}}$
		$V_{CM} = -15\text{V}$ , $f_0 = 10\text{Hz}$		7		nV/ $\sqrt{\text{Hz}}$
		$V_{CM} = 0\text{V}$ , $f_0 = 1\text{kHz}$ (Note 8)		3.2	4.5	nV/ $\sqrt{\text{Hz}}$
		$V_{CM} = 15\text{V}$ , $f_0 = 1\text{kHz}$		17		nV/ $\sqrt{\text{Hz}}$
		$V_{CM} = -15\text{V}$ , $f_0 = 1\text{kHz}$		5.3		nV/ $\sqrt{\text{Hz}}$

**ELECTRICAL CHARACTERISTICS**  $T_A = 25^\circ\text{C}$ ,  $V_S = \pm 15\text{V}$ ,  $V_{CM} = V_O = 0\text{V}$  unless otherwise noted.

SYMBOL	PARAMETER	CONDITIONS (Note 6)	MIN	TYP	MAX	UNITS	
$i_n$	Input Noise Current Density	$f_0 = 10\text{Hz}$ $f_0 = 1\text{kHz}$		1.2 0.3		$\text{pA}/\sqrt{\text{Hz}}$ $\text{pA}/\sqrt{\text{Hz}}$	
$V_{CM}$	Input Voltage Range		$\pm 15.1$	$\pm 15.2$		V	
$R_{IN}$	Input Resistance	Common Mode		2		$\text{G}\Omega$	
$C_{IN}$	Input Capacitance	$V_S = \pm 2.5\text{V}$		3.8 4.2		pF pF	
CMRR	Common Mode Rejection Ratio	$V_{CM} = -13.3\text{V}$ to $14.0\text{V}$ $V_{CM} = \pm 15.1\text{V}$	109 74	130 95		dB dB	
PSRR	Power Supply Rejection Ratio	$V_S = \pm 1.7\text{V}$ to $\pm 18\text{V}$ $V_S = 2.7\text{V}$ to $40\text{V}$ , $V_{CM} = V_O = 1.7\text{V}$	106 108	130 125		dB dB	
$A_{VOL}$	Large-Signal Voltage Gain	$R_L \geq 10\text{k}$ , $V_O = \pm 14\text{V}$ $R_L \geq 1\text{k}$ , $V_O = \pm 13.5\text{V}$ $R_L \geq 600\Omega$ , $V_O = \pm 10\text{V}$	7 4 0.4	25 20 0.7		$\text{V}/\mu\text{V}$ $\text{V}/\mu\text{V}$ $\text{V}/\mu\text{V}$	
		$V_{CC} = 5\text{V}$ or $3\text{V}$ , $V_{EE} = 0\text{V}$ , $V_{CM} = 1.7\text{V}$ , $R_L$ to GND, $V_{OUT} = 0.5\text{V}$ to: $R_L \geq 10\text{k}$ , $V_{CC} - 0.5\text{V}$ $R_L \geq 1\text{k}$ , $V_{CC} - 0.7\text{V}$	2 1.5	10 4		$\text{V}/\mu\text{V}$ $\text{V}/\mu\text{V}$	
$V_{OL}$	Output Voltage Swing Low	Above $V_{EE}$ $I_{SINK} = 0.1\text{mA}$ $I_{SINK} = 2.5\text{mA}$ $I_{SINK} = 10\text{mA}$		80 110 300	170 250 500	mV mV mV	
$V_{OH}$		Output Voltage Swing High	Below $V_{CC}$ $I_{SOURCE} = 0.1\text{mA}$ $I_{SOURCE} = 2.5\text{mA}$ $I_{SOURCE} = 10\text{mA}$		110 190 500	170 300 700	mV mV mV
$I_{SC}$			Output Short-Circuit Current (Note 3)		25	35	mA
SR	Slew Rate		$R_L \geq 10\text{k}$ (Note 9)	1.7	2.5		$\text{V}/\mu\text{s}$
GBW	Gain Bandwidth Product	$f_0 = 100\text{kHz}$	4.5	7.2		MHz	
THD	Total Harmonic Distortion	$R_L = 2\text{k}$ , $A_V = 1$ , $f_0 = 1\text{kHz}$ , $V_O = 10\text{V}_{P-P}$		0.0006		%	
$t_s$	Settling Time	10V Step 0.1%, $A_V = +1$ 10V Step 0.01%, $A_V = +1$		5 6		$\mu\text{s}$ $\mu\text{s}$	
$R_O$		Open-Loop Output Resistance Closed-Loop Output Resistance	$I_{OUT} = 0$ $A_V = 100$ , $f = 10\text{kHz}$		80 1		$\Omega$ $\Omega$
$I_S$	Supply Current			2.75	3.5	mA	

**ELECTRICAL CHARACTERISTICS** The ● denotes the specifications which apply over the temperature range of 0°C < T<sub>A</sub> < 70°C. V<sub>S</sub> = ±15V, V<sub>CM</sub> = V<sub>O</sub> = 0V unless otherwise noted.

SYMBOL	PARAMETER	CONDITIONS (Note 6)	MIN	TYP	MAX	UNITS
V <sub>OS</sub>	Input Offset Voltage	●		30	120	μV
		●	V <sub>CM</sub> = 14.0V to 14.8V	180	550	μV
		●	V <sub>CM</sub> = -13.3V to -15V	1.8	6	mV
$\frac{\Delta V_{OS}}{\Delta Temp}$	Average Input Offset Drift	●	SO-8	0.40	2	μV/°C
		●	N8 (Note 10)	0.20	0.5	μV/°C
I <sub>B</sub>	Input Bias Current	●		±3	±35	nA
		●	V <sub>CM</sub> = 14.0V to 14.8V	0.19	0.6	μA
		●	V <sub>CM</sub> = -13.3V to -15V	-2	-0.43	μA
I <sub>OS</sub>	Input Offset Current	●		2	20	nA
		●	V <sub>CM</sub> = 14.0V to 14.8V	90	220	nA
		●	V <sub>CM</sub> = -13.3V to -15V	90	350	nA
V <sub>CM</sub>	Input Voltage Range	●	-15		14.8	V
CMRR	Common Mode Rejection Ratio	●	V <sub>CM</sub> = -13.3V to 14.0V	106	126	dB
		●	V <sub>CM</sub> = -15V to 14.8V	73	93	dB
PSRR	Power Supply Rejection Ratio	●	V <sub>S</sub> = ±1.7V to ±18V	104	127	dB
		●	V <sub>S</sub> = 2.8V to 40V, V <sub>CM</sub> = V <sub>O</sub> = 1.7V	106	122	dB
A <sub>VOL</sub>	Large-Signal Voltage Gain	●	R <sub>L</sub> ≥ 10k, V <sub>O</sub> = ±14V	4	20	V/μV
		●	R <sub>L</sub> ≥ 1k, V <sub>O</sub> = ±13.5V	2	10	V/μV
		●	R <sub>L</sub> ≥ 600Ω, V <sub>O</sub> = ±10V	0.3	0.5	V/μV
		●	V <sub>CC</sub> = 5V or 3V, V <sub>EE</sub> = 0V, V <sub>CM</sub> = 1.7V, V <sub>OUT</sub> = 0.4V to: R <sub>L</sub> ≥ 10k, V <sub>CC</sub> - 0.5V R <sub>L</sub> ≥ 1k, V <sub>CC</sub> - 0.7V	3 0.5	8 4	V/μV V/μV
V <sub>OL</sub>	Output Voltage Swing Low	●	Above V <sub>EE</sub> I <sub>SINK</sub> = 0.1mA	85	200	mV
		●	I <sub>SINK</sub> = 2.5mA	160	320	mV
		●	I <sub>SINK</sub> = 10mA	400	600	mV
V <sub>OH</sub>	Output Voltage Swing High	●	Below V <sub>CC</sub> I <sub>SOURCE</sub> = 0.1mA	140	200	mV
		●	I <sub>SOURCE</sub> = 2.5mA	230	350	mV
		●	I <sub>SOURCE</sub> = 10mA	580	800	mV
I <sub>SC</sub>	Output Short-Circuit Current (Note 3)	●	20	27		mA
SR	Slew Rate	●	R <sub>L</sub> ≥ 10k (Note 9)	1.5	2.3	V/μs
GBW	Gain Bandwidth Product	●	f <sub>0</sub> = 100kHz	6.2		MHz
I <sub>S</sub>	Supply Current	●		3.0	3.9	mA

**ELECTRICAL CHARACTERISTICS** The ● denotes the specifications which apply over the temperature range of  $-40^{\circ}\text{C} < T_A < 85^{\circ}\text{C}$ .  $V_S = \pm 15\text{V}$ ,  $V_{CM} = V_O = 0\text{V}$  unless otherwise noted. (Note 5)

SYMBOL	PARAMETER	CONDITIONS (Note 6)	MIN	TYP	MAX	UNITS
$V_{OS}$	Input Offset Voltage	●		45	180	$\mu\text{V}$
		●	$V_{CM} = 14.0\text{V to } 14.7\text{V}$	200	650	$\mu\text{V}$
		●	$V_{CM} = -13.3\text{V to } -15\text{V}$	2	6.5	mV
$\frac{\Delta V_{OS}}{\Delta \text{Temp}}$	Average Input Offset Drift	●	SO-8	0.40	2.0	$\mu\text{V}/^{\circ}\text{C}$
		●	N8 (Note 10)	0.20	0.5	$\mu\text{V}/^{\circ}\text{C}$
$I_B$	Input Bias Current	●		$\pm 7$	$\pm 50$	nA
		●	$V_{CM} = 14.0\text{V to } 14.7\text{V}$	0.25	0.75	$\mu\text{A}$
		●	$V_{CM} = -13.3\text{V to } -15\text{V}$	-2.3	-0.45	$\mu\text{A}$
$I_{OS}$	Input Offset Current	●		6	40	nA
		●	$V_{CM} = 14.0\text{V to } 14.7\text{V}$	100	250	nA
		●	$V_{CM} = -13.3\text{V to } -15\text{V}$	100	400	nA
$V_{CM}$	Input Voltage Range	●	-15		14.7	V
CMRR	Common Mode Rejection Ratio	●	$V_{CM} = -13.3\text{V to } 14.0\text{V}$	105	124	dB
		●	$V_{CM} = -15\text{V to } 14.7\text{V}$	72	91	dB
PSRR	Power Supply Rejection Ratio	●	$V_S = \pm 1.7\text{V to } \pm 18\text{V}$	103	125	dB
		●	$V_S = 3.1\text{V to } 40\text{V}$ , $V_{CM} = V_O = 1.7\text{V}$	105	120	dB
$A_{VOL}$	Large-Signal Voltage Gain	●	$R_L \geq 10\text{k}$ , $V_O = \pm 14\text{V}$	3	17	$\text{V}/\mu\text{V}$
		●	$R_L \geq 1\text{k}$ , $V_O = \pm 13.5\text{V}$	1.5	8	$\text{V}/\mu\text{V}$
		●	$R_L \geq 600\Omega$ , $V_O = \pm 10\text{V}$	0.2	0.35	$\text{V}/\mu\text{V}$
		●	$V_{CC} = 5\text{V or } 3\text{V}$ , $V_{EE} = 0\text{V}$ , $V_{CM} = 1.7\text{V}$ , $V_{OUT} = 0.5\text{V to}$ :			
		●	$R_L \geq 10\text{k}$ , $V_{CC} - 0.5\text{V}$ $R_L \geq 1\text{k}$ , $V_{CC} - 0.7\text{V}$	2	15	$\text{V}/\mu\text{V}$
$V_{OL}$	Output Voltage Swing Low	●	Above $V_{EE}$			
		●	$I_{SINK} = 0.1\text{mA}$	90	230	mV
		●	$I_{SINK} = 2.5\text{mA}$	175	350	mV
$V_{OH}$	Output Voltage Swing High	●	Below $V_{CC}$			
		●	$I_{SOURCE} = 0.1\text{mA}$	150	250	mV
$I_{SC}$	Output Short-Circuit Current (Note 3)	●	$I_{SOURCE} = 2.5\text{mA}$	250	375	mV
		●	$I_{SOURCE} = 10\text{mA}$	600	850	mV
$I_{SC}$	Output Short-Circuit Current (Note 3)	●		18	25	mA
SR	Slew Rate	●	$R_L \geq 10\text{k}$ (Note 9)	1.2	2.0	$\text{V}/\mu\text{s}$
GBW	Gain Bandwidth Product	●	$f_0 = 100\text{kHz}$	5.8		MHz
$I_S$	Supply Current	●		3.1	4.0	mA

**Note 1:** Absolute Maximum Ratings are those values beyond which the life of the device may be impaired.

**Note 2:** The inputs are protected by back-to-back diodes. Current limiting resistors are not used in order to achieve low noise. If differential input voltage exceeds  $\pm 1.4\text{V}$ , the input current should be limited to 25mA. If the common mode range exceeds either rail, the input current should be limited to 10mA.

**Note 3:** A heat sink may be required to keep the junction temperature below absolute maximum.

**Note 4:** The LT1677C and LTC1677I are guaranteed functional over the Operating Temperature Range of  $-40^{\circ}\text{C}$  to  $85^{\circ}\text{C}$ .

**Note 5:** The LT1677C is guaranteed to meet specified performance from  $0^{\circ}\text{C}$  to  $70^{\circ}\text{C}$ . The LT1677C is designed, characterized and expected to

meet specified performance from  $-40^{\circ}\text{C}$  to  $85^{\circ}\text{C}$  but is not tested or QA sampled at these temperatures. The LT1677I is guaranteed to meet the extended temperature limits.

**Note 6:** Typical parameters are defined as the 60% yield of parameter distributions of individual amplifier; i.e., out of 100 LT1677s, typically 60 op amps will be better than the indicated specification.

**Note 7:** See the test circuit and frequency response curve for 0.1Hz to 10Hz tester in the Applications Information section of the LT1677 data sheet.

**Note 8:** Noise is 100% tested.

**Note 9:** Slew rate is measured in  $A_V = -1$ ; input signal is  $\pm 7.5\text{V}$ , output measured at  $\pm 2.5\text{V}$ .

**Note 10:** This parameter is not 100% tested.

TYPICAL PERFORMANCE CHARACTERISTICS

Voltage Noise vs Frequency

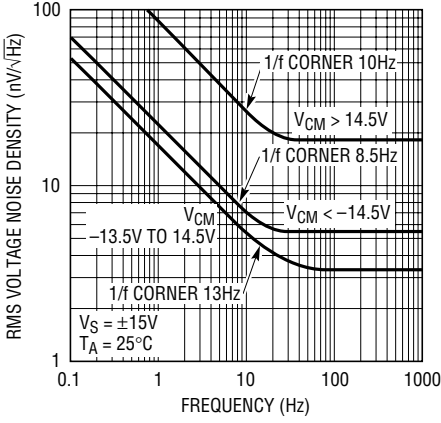

1677 G03

Current Noise vs Frequency

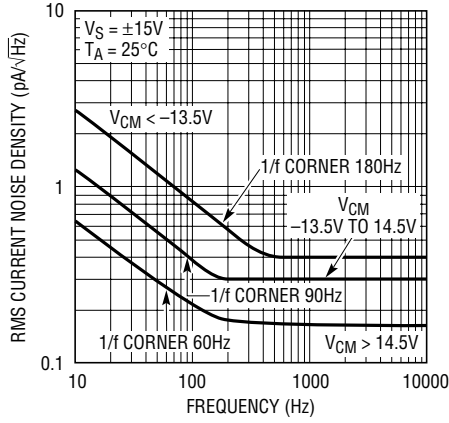

1677 G04

Voltage Noise vs Temperature

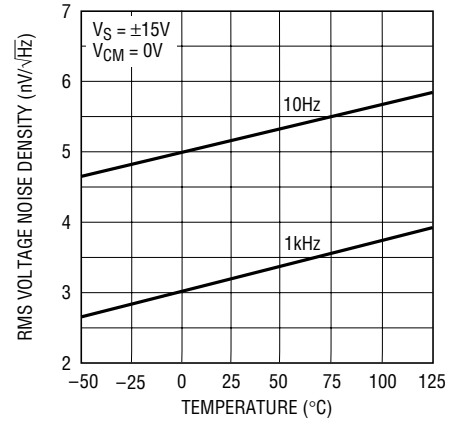

1677 G05

Input Bias Current Over the Common Mode Range

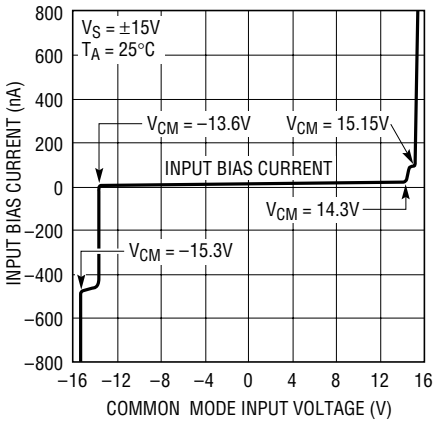

1677 G06

Offset Voltage Shift vs Common Mode

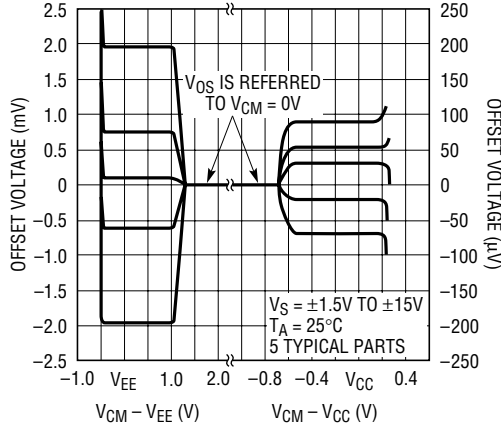

1677 G08

V<sub>OS</sub> vs Temperature of Representative Units

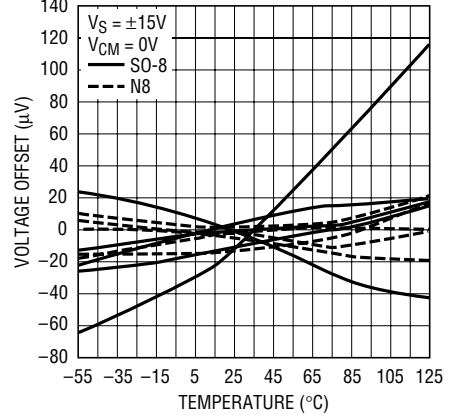

1677 G11

Common Mode Range vs Temperature

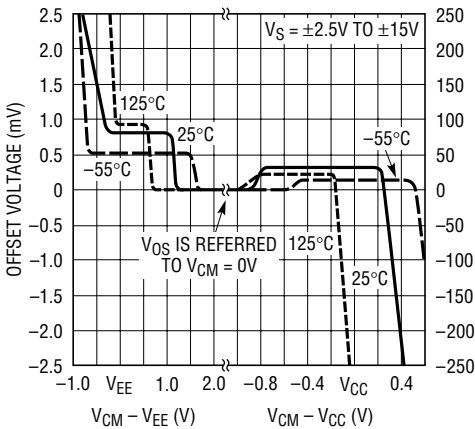

1677 G09

Distribution of Input Offset Voltage Drift (N8)

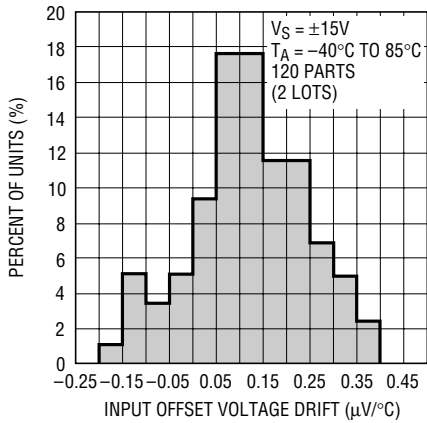

1677 G02

Long-Term Stability of Four Representative Units

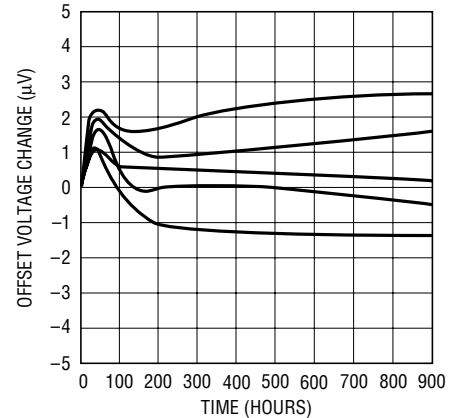

1677 G13

# TYPICAL PERFORMANCE CHARACTERISTICS

Supply Current vs Supply Voltage

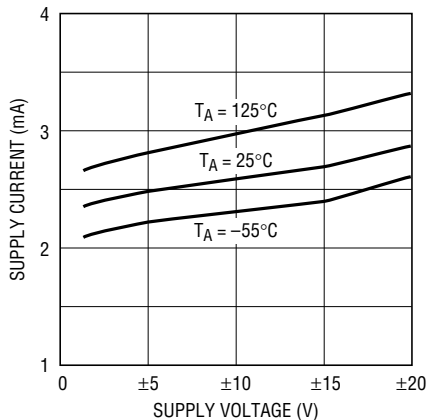

1677 G28

Common Mode Rejection Ratio vs Frequency

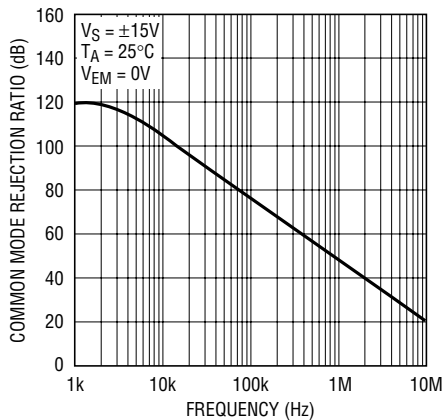

1677 G14

Power Supply Rejection Ratio vs Frequency

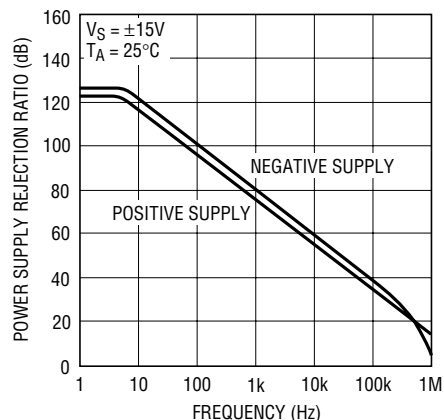

1677 G15

Voltage Gain vs Frequency

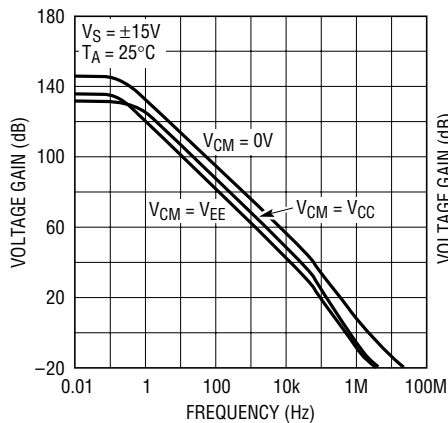

1677 G16

Gain, Phase Shift vs Frequency

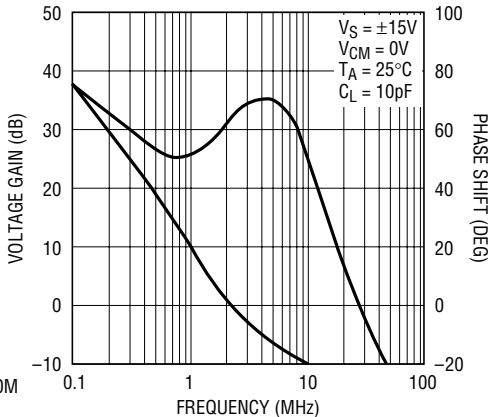

1677 G17

Overshoot vs Load Capacitance

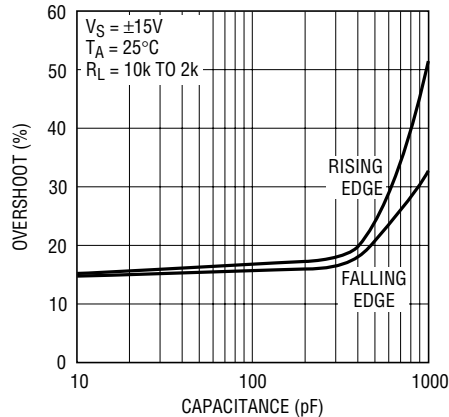

1677 G30

PM, GBWP, SR vs Temperature

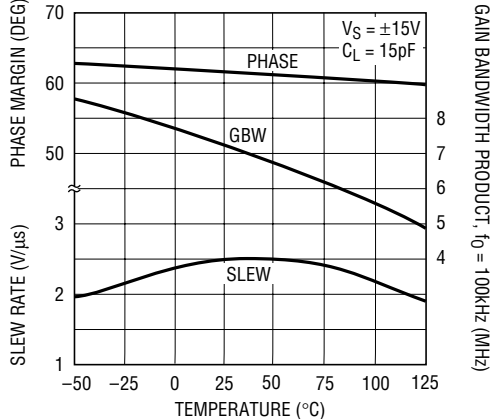

1677 G29

Large-Signal Transient Response

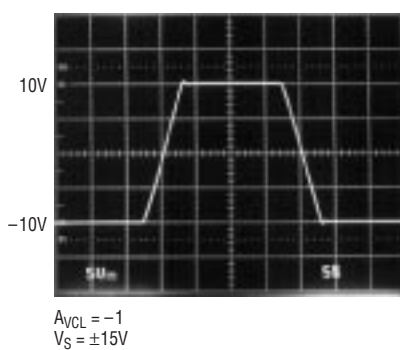

Small-Signal Transient Response

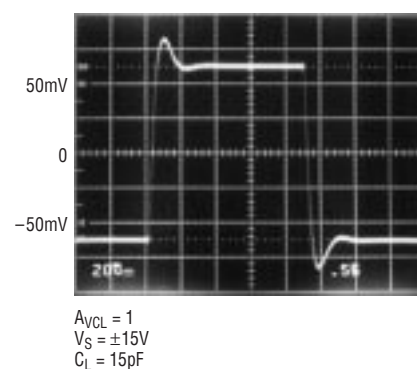

# TYPICAL PERFORMANCE CHARACTERISTICS

**Settling Time vs Output Step (Inverting)**

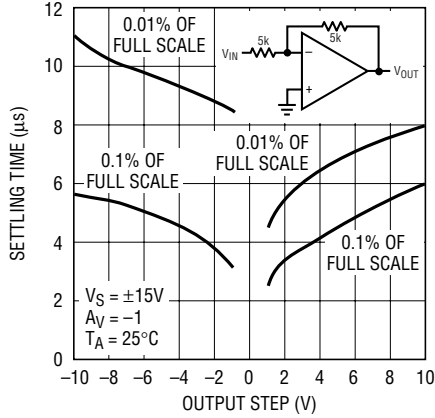

1677 G32

**Settling Time vs Output Step (Noninverting)**

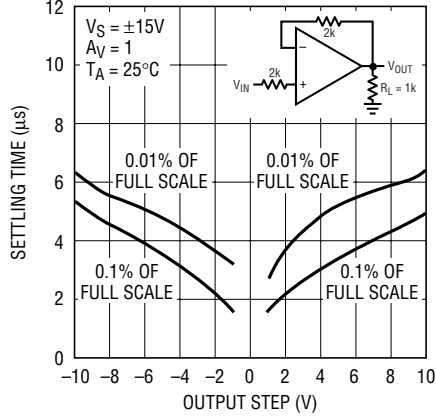

1677 G33

**Output Voltage Swing vs Load Current**

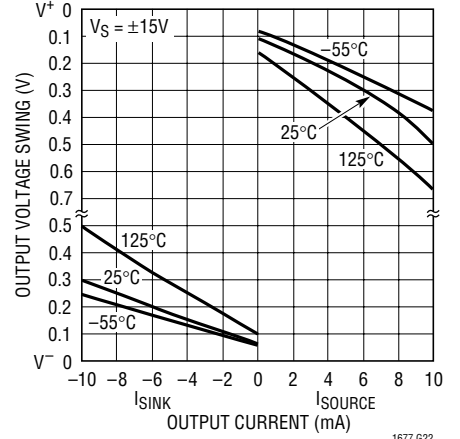

1677 G22

**Output Short-Circuit Current vs Time**

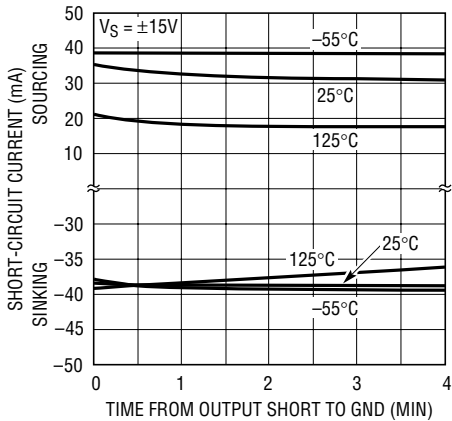

1677 G23

**Closed-Loop Output Impedance vs Frequency**

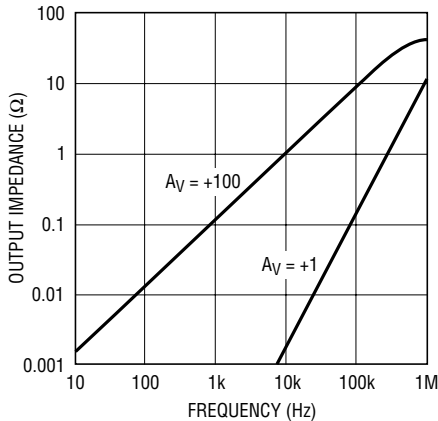

1677 G31

**Total Harmonic Distortion and Noise vs Frequency for Noninverting Gain**

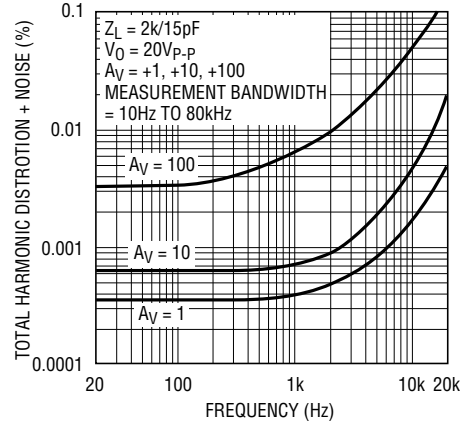

1677 G24

**Total Harmonic Distortion and Noise vs Frequency for Inverting Gain**

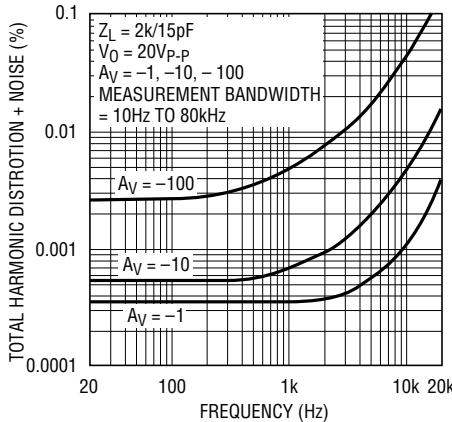

1677 G25

**Total Harmonic Distortion and Noise vs Output Amplitude for Noninverting Gain**

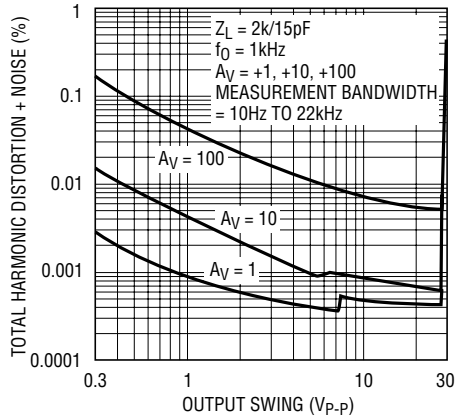

1677 G26

**Total Harmonic Distortion and Noise vs Output Amplitude for Inverting Gain**

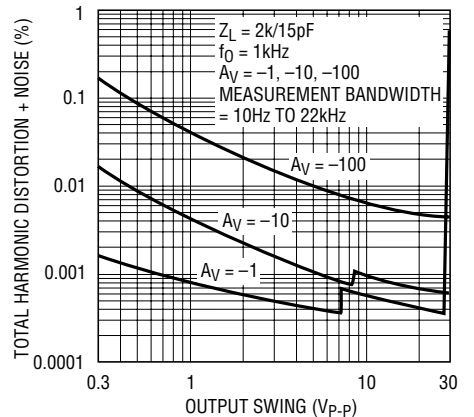

1677 G27



## APPLICATIONS INFORMATION

### General

The LT1677 series devices may be inserted directly into OP-07, OP-27, OP-37 and sockets with or without removal of external compensation or nulling components. In addition, the LT1677 may be fitted to 741 sockets with the removal or modification of external nulling components.

### Rail-to-Rail Operation

To take full advantage of an input range that can exceed the supply, the LT1677 is designed to eliminate phase reversal. Referring to the photographs shown in Figure 1, the LT1677 is operating in the follower mode ( $A_V = +1$ ) at a single 3V supply. The output of the LT1677 clips cleanly and recovers with no phase reversal. This has the benefit of preventing lock-up in servo systems and minimizing distortion components.

### Offset Voltage Adjustment

The input offset voltage of the LT1677 and its drift with temperature are permanently trimmed at wafer testing to a low level. However, if further adjustment of  $V_{OS}$  is necessary, the use of a 10k $\Omega$  nulling potentiometer will not degrade drift with temperature. Trimming to a value other than zero creates a drift of  $(V_{OS}/300)\mu V/^\circ C$ , e.g., if  $V_{OS}$  is adjusted to 300 $\mu V$ , the change in drift will be 1 $\mu V/^\circ C$  (Figure 2).

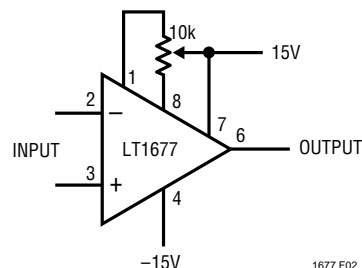

Figure 2. Standard Adjustment

The adjustment range with a 10k $\Omega$  pot is approximately  $\pm 2.5mV$ . If less adjustment range is needed, the sensitivity and resolution of the nulling can be improved by using a smaller pot in conjunction with fixed resistors. The example has an approximate null range of  $\pm 200\mu V$  (Figure 3).

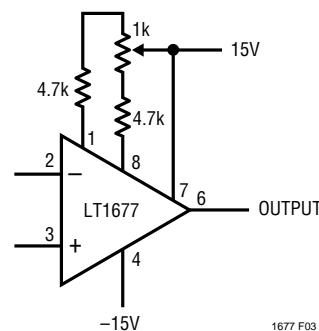

Figure 3. Improved Sensitivity Adjustment

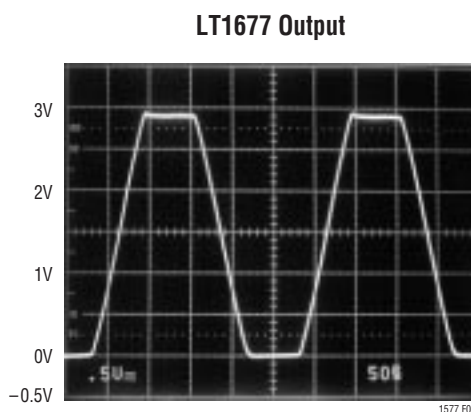
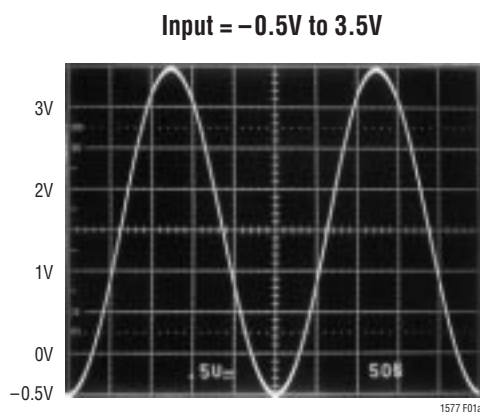

Figure 1. Voltage Follower with Input Exceeding the Supply Voltage ( $V_S = 3V$ )

## APPLICATIONS INFORMATION

### Offset Voltage and Drift

Thermocouple effects, caused by temperature gradients across dissimilar metals at the contacts to the input terminals, can exceed the inherent drift of the amplifier unless proper care is exercised. Air currents should be minimized, package leads should be short, the two input leads should be close together and maintained at the same temperature.

The circuit shown to measure offset voltage is also used as the burn-in configuration for the LT1677, with the supply voltages increased to  $\pm 20V$  (Figure 4).

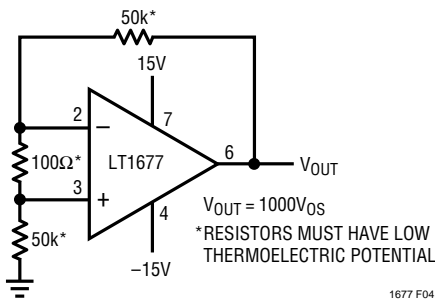

Figure 4. Test Circuit for Offset Voltage and Offset Voltage Drift with Temperature

### Unity-Gain Buffer Application

When  $R_F \leq 100\Omega$  and the input is driven with a fast, large-signal pulse ( $>1V$ ), the output waveform will look as shown in the pulsed operation diagram (Figure 5).

During the fast feedthrough-like portion of the output, the input protection diodes effectively short the output to the input and a current, limited only by the output short-circuit protection, will be drawn by the signal generator. With  $R_F \geq 500\Omega$ , the output is capable of handling the current requirements ( $I_L \leq 20mA$  at  $10V$ ) and the amplifier stays in its active mode and a smooth transition will occur.

As with all operational amplifiers when  $R_F > 2k$ , a pole will be created with  $R_F$  and the amplifier's input capacitance,

creating additional phase shift and reducing the phase margin. A small capacitor ( $20pF$  to  $50pF$ ) in parallel with  $R_F$  will eliminate this problem.

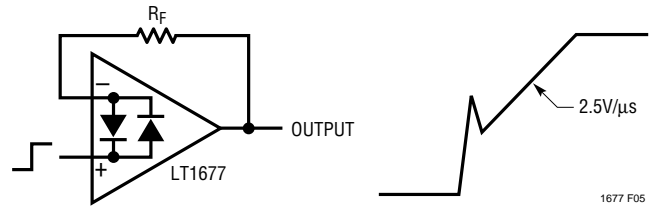

Figure 5. Pulsed Operation

### Noise Testing

The  $0.1Hz$  to  $10Hz$  peak-to-peak noise of the LT1677 is measured in the test circuit shown (Figure 6a). The frequency response of this noise tester (Figure 6b) indicates that the  $0.1Hz$  corner is defined by only one zero. The test time to measure  $0.1Hz$  to  $10Hz$  noise should not exceed ten seconds, as this time limit acts as an additional zero to eliminate noise contributions from the frequency band below  $0.1Hz$ .

Measuring the typical  $70nV$  peak-to-peak noise performance of the LT1677 requires special test precautions:

1. The device should be warmed up for at least five minutes. As the op amp warms up, its offset voltage changes typically  $3\mu V$  due to its chip temperature increasing  $10^\circ C$  to  $20^\circ C$  from the moment the power supplies are turned on. In the ten-second measurement interval these temperature-induced effects can easily exceed tens of nanovolts.
2. For similar reasons, the device must be well shielded from air currents to eliminate the possibility of thermoelectric effects in excess of a few nanovolts, which would invalidate the measurements.
3. Sudden motion in the vicinity of the device can also "feedthrough" to increase the observed noise.

## APPLICATIONS INFORMATION

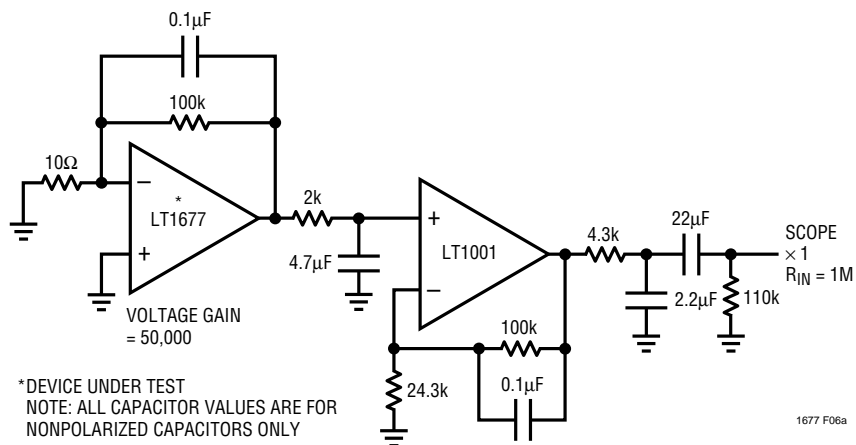

Figure 6a. 0.1Hz to 10Hz Noise Test Circuit

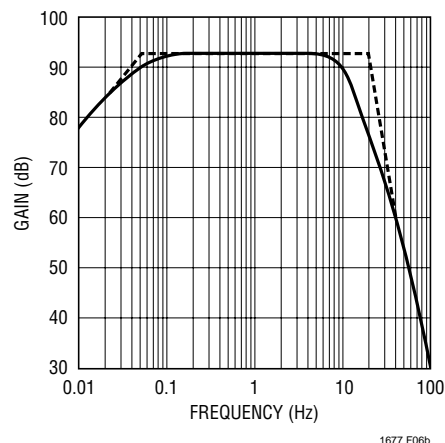

Figure 6b. 0.1Hz to 10Hz Peak-to-Peak Noise Tester Frequency Response

Current noise is measured in the circuit shown in Figure 7 and calculated by the following formula:

$$i_n = \frac{\left[ (e_{no})^2 - (130\text{nV} \cdot 101)^2 \right]^{1/2}}{(1\text{M}\Omega)(101)}$$

The LT1677 achieves its low noise, in part, by operating the input stage at 120µA versus the typical 10µA of most other op amps. Voltage noise is inversely proportional while current noise is directly proportional to the square root of the input stage current. Therefore, the LT1677's current noise will be relatively high. At low frequencies, the low 1/f current noise corner frequency ( $\approx 90\text{Hz}$ ) minimizes current noise to some extent.

In most practical applications, however, current noise will not limit system performance. This is illustrated in the Total Noise vs Source Resistance plot (Figure 8) where:

$$\text{Total Noise} = \left[ (\text{voltage noise})^2 + (\text{current noise} \cdot R_S)^2 + (\text{resistor noise})^2 \right]^{1/2}$$

Three regions can be identified as a function of source resistance:

- (i)  $R_S \leq 400\Omega$ . Voltage noise dominates
- (ii)  $400\Omega \leq R_S \leq 50\text{k}$  at 1kHz } Resistor noise dominates
- $400\Omega \leq R_S \leq 8\text{k}$  at 10Hz } Resistor noise dominates

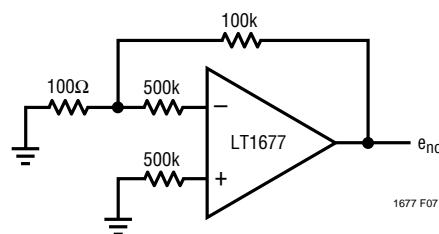

Figure 7

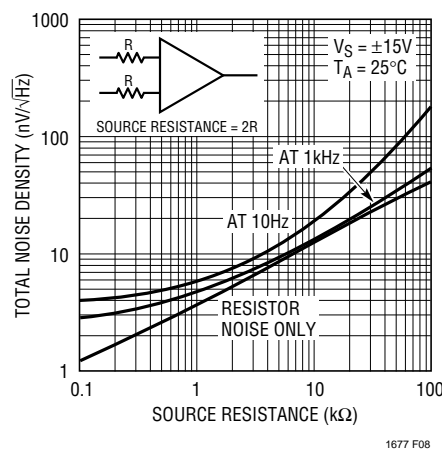

Figure 8. Total Noise vs Source Resistance

- (iii)  $R_S > 50\text{k}$  at 1kHz } Current noise dominates
- $R_S > 8\text{k}$  at 10Hz } Current noise dominates

Clearly the LT1677 should not be used in region (iii), where total system noise is at least six times higher than the

## APPLICATIONS INFORMATION

voltage noise of the op amp, i.e., the low voltage noise specification is completely wasted. In this region the LT1792 or LT1793 is the best choice.

### Rail-to-Rail Input

The LT1677 has the lowest voltage noise, offset voltage and highest gain when compared to any rail-to-rail op amp. The input common mode range for the LT1677 can exceed the supplies by at least 100mV. As the common mode voltage approaches the positive rail ( $V_{CC} - 0.7V$ ), the tail current for the input pair (Q1, Q2) is reduced, which prevents the input pair from saturating (refer to the Simplified Schematic). The voltage drop across the load

resistors  $R_{C1}$ ,  $R_{C2}$  is reduced to less than 200mV, degrading the slew rate, bandwidth voltage noise, offset voltage and input bias current (the cancellation is shut off).

When the input common mode range goes below 1.5V above the negative rail, the NPN input pair (Q1, Q2) shuts off and the PNP input pair (Q8, Q9) turns on. The offset voltage, input bias current, voltage noise and bandwidth are also degraded. The graph of Offset Voltage vs Common Mode Range shows where the knees occur by displaying the change in offset voltage. The change-over points are temperature dependent, see Common Mode Range vs Temperature.

## TYPICAL APPLICATION

Microvolt Comparator with Hysteresis

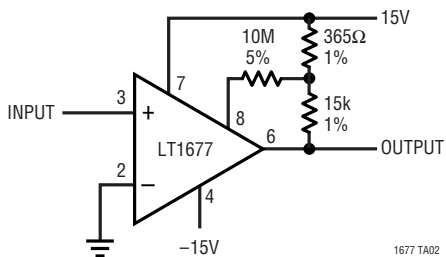

POSITIVE FEEDBACK TO ONE OF THE NULLING TERMINALS CREATES APPROXIMATELY  $5\mu V$  OF HYSTERESIS. OUTPUT CAN SINK 16mA  
 INPUT OFFSET VOLTAGE IS TYPICALLY CHANGED LESS THAN  $5\mu V$  DUE TO THE FEEDBACK

SIMPLIFIED SCHEMATIC

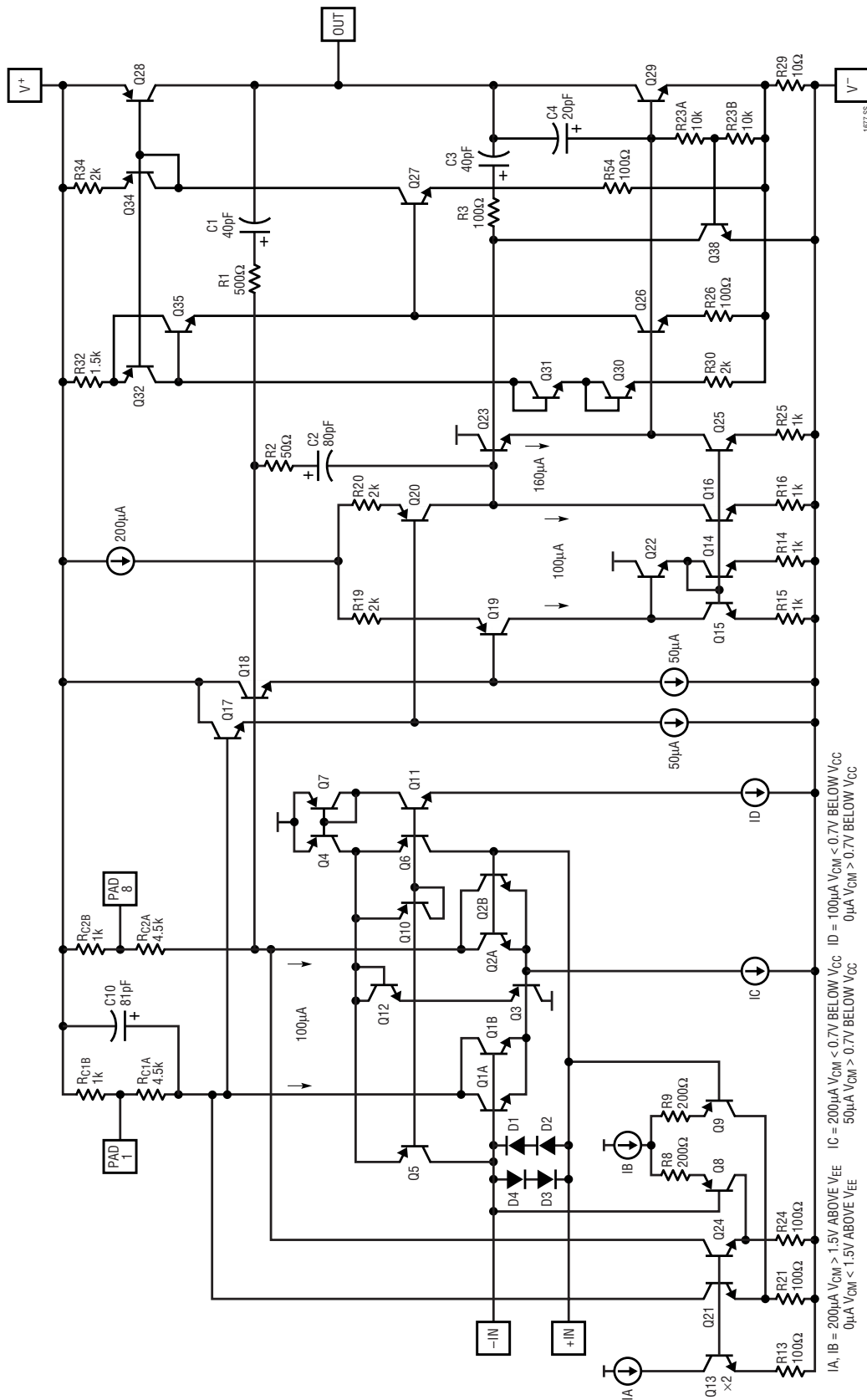

**PACKAGE DESCRIPTION**

Dimensions in inches (millimeters) unless otherwise noted.

**N8 Package**  
**8-Lead PDIP (Narrow 0.300)**  
 (LTC DWG # 05-08-1510)

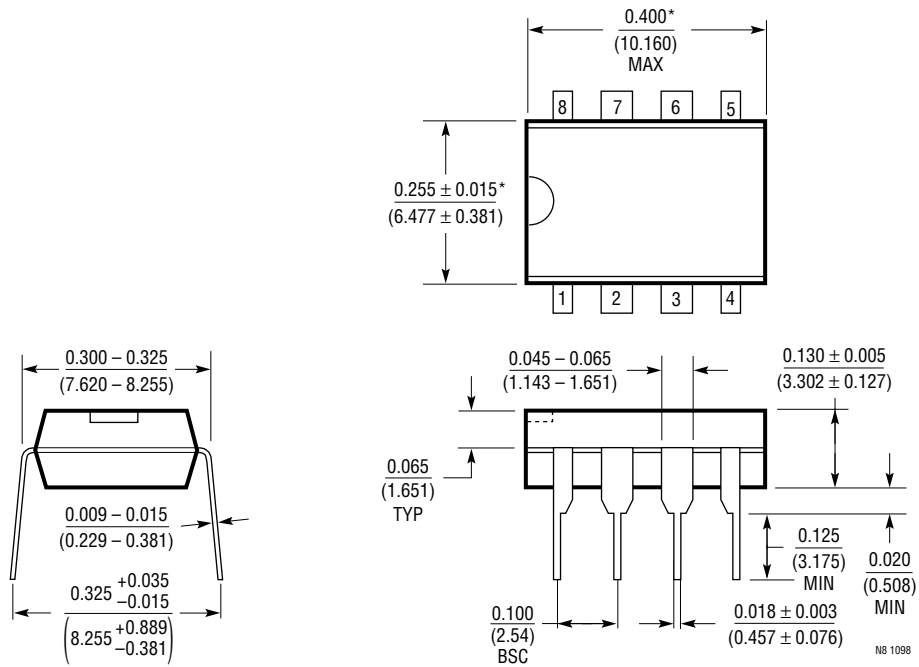

\*THESE DIMENSIONS DO NOT INCLUDE MOLD FLASH OR PROTRUSIONS.  
 MOLD FLASH OR PROTRUSIONS SHALL NOT EXCEED 0.010 INCH (0.254mm)

**PACKAGE DESCRIPTION**

Dimensions in inches (millimeters) unless otherwise noted.

**S8 Package**  
**8-Lead Plastic Small Outline (Narrow 0.150)**  
 (LTC DWG # 05-08-1610)

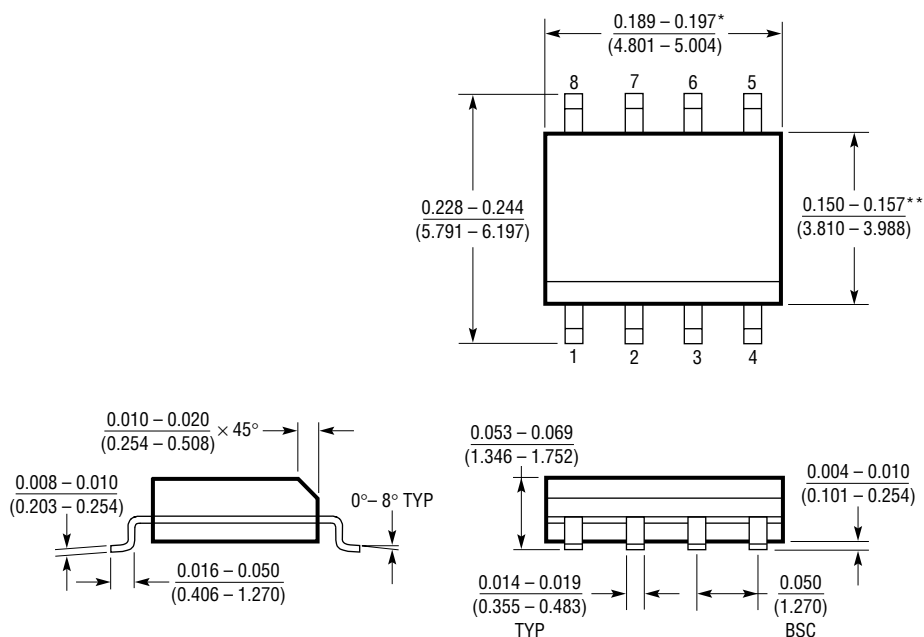

\* DIMENSION DOES NOT INCLUDE MOLD FLASH. MOLD FLASH SHALL NOT EXCEED 0.006" (0.152mm) PER SIDE  
 \*\* DIMENSION DOES NOT INCLUDE INTERLEAD FLASH. INTERLEAD FLASH SHALL NOT EXCEED 0.010" (0.254mm) PER SIDE

S08 1298

## TYPICAL APPLICATION

This 2-wire remote Geophone preamp operates on a current-loop principle and so has good noise immunity. Quiescent current is  $\approx 10\text{mA}$  for a  $V_{OUT}$  of  $2.5\text{V}$ . Excitation will cause AC currents about this point of  $\pm 4\text{mA}$  for a  $V_{OUT}$  of  $\pm 1\text{V}$  max. The op amp is configured for a voltage

gain of  $\sim 107$ . Components R5 and Q1 convert the voltage into a current for transmission back to R10, which converts it into a voltage again. The LM334 and 2N3904 are not temperature compensated so the DC output contains temperature information.

2-Wire Remote Geophone Preamp

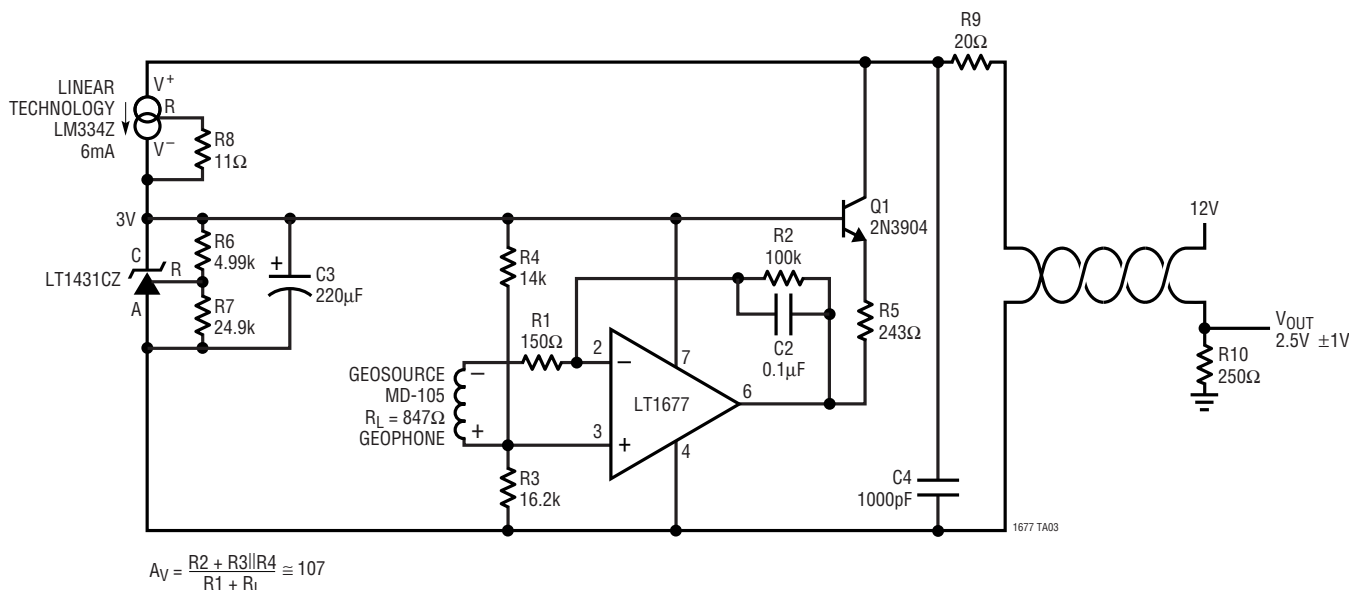

## RELATED PARTS

PART NUMBER	DESCRIPTION	COMMENTS
LT1028	Ultralow Noise Precision Op Amp	Lowest Noise $0.85\text{nV}/\sqrt{\text{Hz}}$
LT1115	Ultralow Noise, Low distortion Audio Op Amp	$0.002\%$ THD, Max Noise $1.2\text{nV}/\sqrt{\text{Hz}}$
LT1124/LT1125	Dual/Quad Low Noise, High Speed Precision Op Amps	Similar to LT1007
LT1126/LT1127	Dual/Quad Decompensated Low Noise, High Speed Precision Op Amps	Similar to LT1037
LT1498/LT1499	10MHz, $5\text{V}/\mu\text{s}$ , Dual/Quad Rail-to-Rail Input and Output Op Amps	Precision C-Load™ Stable
LT1792	Low Noise, Precision JFET Input Op Amp	$4.2\text{nV}/\sqrt{\text{Hz}}$ , $10\text{fA}/\sqrt{\text{Hz}}$
LT1793	Low Noise, Picoampere Bias Current Op Amp	$6\text{nV}/\sqrt{\text{Hz}}$ , $1\text{fA}/\sqrt{\text{Hz}}$
LT1884	Dual Rail-to-Rail Output Picoamp Input Precision Op Amp	$2.2\text{MHz}$ Bandwidth, $1.2\text{V}/\mu\text{s}$ SR

C-Load is a trademark of Linear Technology Corporation.