

General Description

The AAT7357 is a low threshold dual MOSFET designed for the battery, cell phone, and PDA markets. Using AnalogicTech™'s ultra high density MOSFET process and space saving small outline J-lead package, performance superior to that normally found in a TSSOP-8 footprint has been squeezed into the footprint of a TSOPJW-8 package.

Features

- $V_{DS(MAX)} = -20V$
- $I_{D(MAX)}^1 = -5A @ 25^\circ C$
- Low $R_{DS(ON)}$:
 - $39 m\Omega @ V_{GS} = -4.5V$
 - $63 m\Omega @ V_{GS} = -2.5V$

Applications

- Battery Packs
- Cellular & Cordless Telephones
- Battery-powered portable equipment

Dual TSOPJW-8 Package

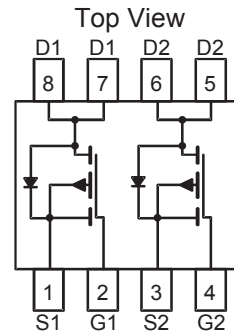

Absolute Maximum Ratings ($T_A=25^\circ C$ unless otherwise noted)

Symbol	Description	Value	Units	
V_{DS}	Drain-Source Voltage	-20	V	
V_{GS}	Gate-Source Voltage	± 12		
I_D	Continuous Drain Current @ $T_J=150^\circ C$ ¹	$T_A = 25^\circ C$	± 5	A
		$T_A = 70^\circ C$	± 4	
I_{DM}	Pulsed Drain Current ²	± 12		
I_S	Continuous Source Current (Source-Drain Diode) ¹	-1.3		
P_D	Maximum Power Dissipation ¹	$T_A = 25^\circ C$	1.6	W
		$T_A = 70^\circ C$	1.0	
T_J, T_{STG}	Operating Junction and Storage Temperature Range	-55 to 150	$^\circ C$	

Thermal Characteristics

Symbol	Description	Typ	Max	Units
$R_{\theta JA}$	Junction-to-Ambient steady state, one FET on ¹	115	140	$^\circ C/W$
$R_{\theta JA2}$	Junction-to-Ambient $t < 5$ seconds ¹	64	78	$^\circ C/W$
$R_{\theta JF}$	Junction-to-Foot ¹	60	72	$^\circ C/W$

Electrical Characteristics (T_J=25°C unless otherwise noted)

Symbol	Description	Conditions	Min	Typ	Max	Units
DC Characteristics						
BV _{DSS}	Drain-Source Breakdown Voltage	V _{GS} =0V, I _D =-250μA	-20			V
R _{DS(ON)}	Drain-Source ON-Resistance ²	V _{GS} =-4.5V, I _D =-5A		30	39	mΩ
		V _{GS} =-2.5V, I _D =-4A		49	63	
I _{D(ON)}	On-State Drain Current ²	V _{GS} =-4.5V, V _{DS} =-5V (Pulsed)	-12			A
V _{GS(th)}	Gate Threshold Voltage	V _{GS} =V _{DS} , I _D =-250μA	-0.6			V
I _{GSS}	Gate-Body Leakage Current	V _{GS} =±12V, V _{DS} =0V			±100	nA
I _{DSS}	Drain Source Leakage Current	V _{GS} =0V, V _{DS} =-20V			-1	μA
		V _{GS} =0V, V _{DS} =-16V, T _J =70°C ³			-5	
g _{fs}	Forward Transconductance ²	V _{DS} =-5V, I _D =-5A		12		S
Dynamic Characteristics ³						
Q _G	Total Gate Charge	V _{DS} =-10V, R _D =2.0Ω, V _{GS} =-4.5V		14		nC
Q _{GS}	Gate-Source Charge	V _{DS} =-10V, R _D =2.0Ω, V _{GS} =-4.5V		3.5		
Q _{GD}	Gate-Drain Charge	V _{DS} =-10V, R _D =2.0Ω, V _{GS} =-4.5V		5.6		
t _{D(ON)}	Turn-ON Delay	V _{DS} =-10V, R _D =2.0Ω, V _{GS} =-4.5V, R _G =6Ω		TBD		ns
t _R	Turn-ON Rise Time	V _{DS} =-10V, R _D =2.0Ω, V _{GS} =-4.5V, R _G =6Ω		TBD		
t _{D(OFF)}	Turn-OFF Delay	V _{DS} =-10V, R _D =2.0Ω, V _{GS} =-4.5V, R _G =6Ω		TBD		
t _F	Turn-OFF Fall Time	V _{DS} =-10V, R _D =2.0Ω, V _{GS} =-4.5V, R _G =6Ω		TBD		
Source-Drain Diode Characteristics						
V _{SD}	Source-Drain Forward Voltage ²	V _{GS} =0, I _S =-5A			-1.2	V
I _S	Continuous Diode Current ¹				-1.3	A

Notes:

1. Based on thermal dissipation from junction to ambient while mounted on a 1" x 1" PCB with optimized layout. A 5 second pulse on a 1" x 1" PCB approximates testing a device mounted on a large multi-layer PCB as in most applications. R_{θJF} + R_{θFA} = R_{θJA} where the foot thermal reference is defined as the normal solder mounting surface of the device's leads. R_{θJF} is guaranteed by design, however R_{θCA} is determined by the PCB design. Actual maximum continuous current is limited by the application's design.

2. Pulse test: Pulse Width = 300 μs

3. Guaranteed by design. Not subject to production testing.

Typical Characteristics

($T_J = 25^\circ\text{C}$ unless otherwise noted)

Output Characteristics

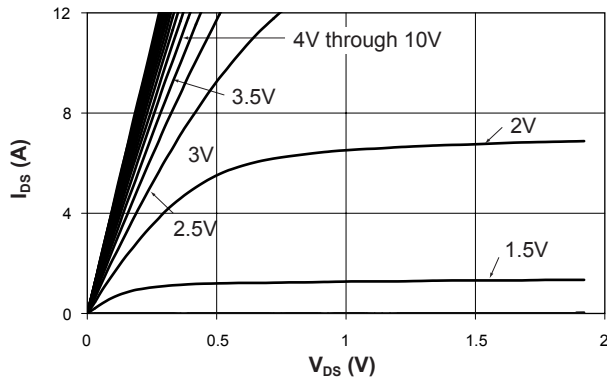

Transfer Characteristics

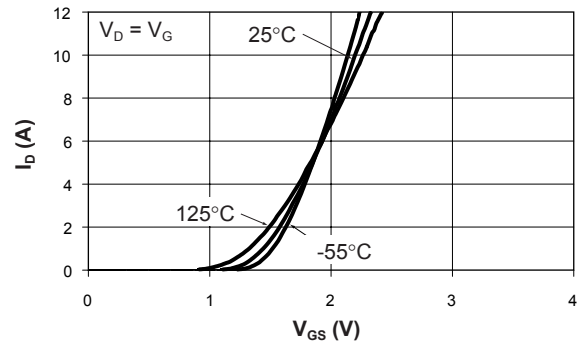

On-Resistance vs. Drain Current

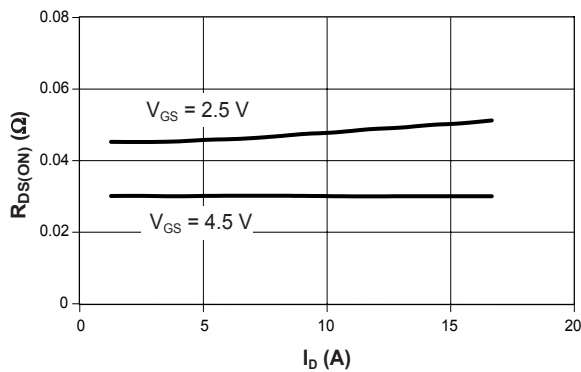

On-Resistance vs. Gate to Source Voltage

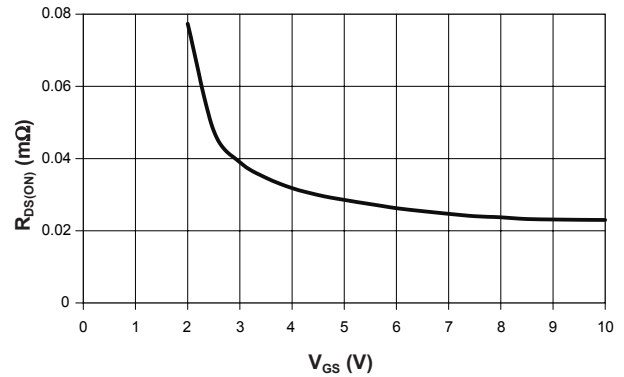

On-Resistance vs. Junction Temperature

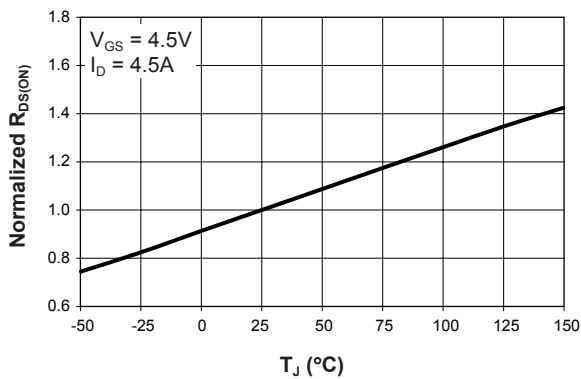

Threshold Voltage

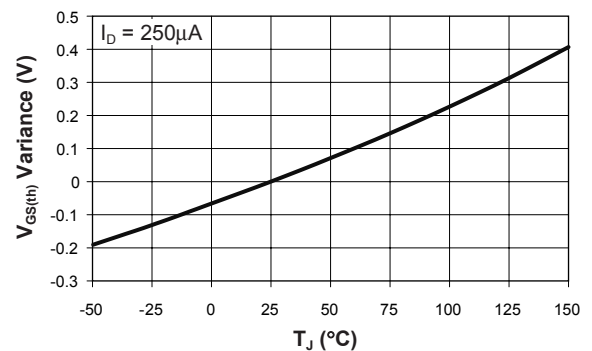

Typical Characteristics

($T_J = 25^\circ\text{C}$ unless otherwise noted)

Source-Drain Diode Forward Voltage

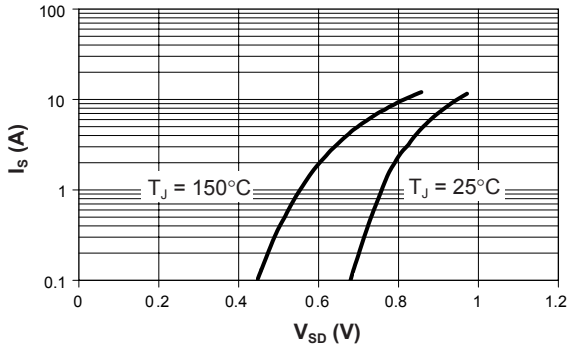

Single Pulse Power, Junction to Ambient

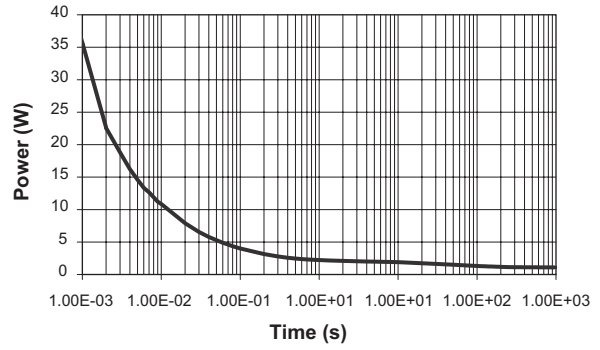

Transient Thermal Response, Junction to Ambient

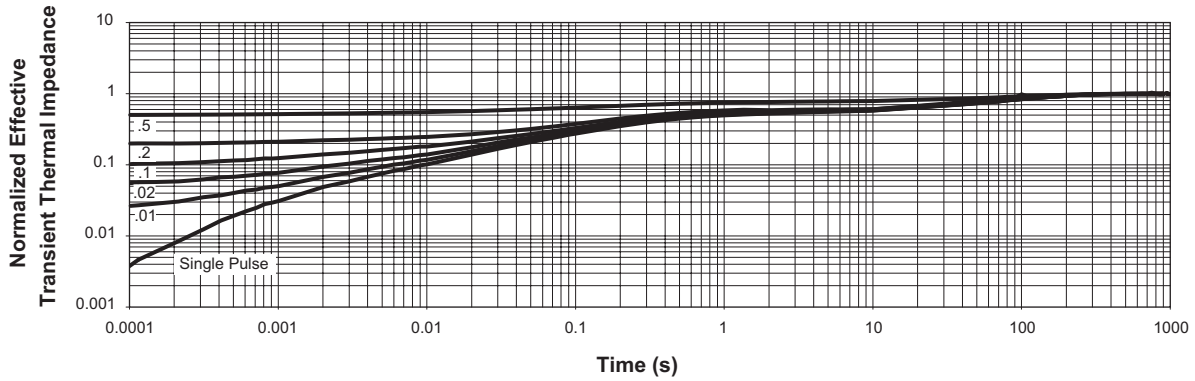

Ordering Information

Package	Marking	Part Number (Tape and Reel)
TSOPJW-8		AAT7357ITS-T1

Package Information

TSOPJW-8

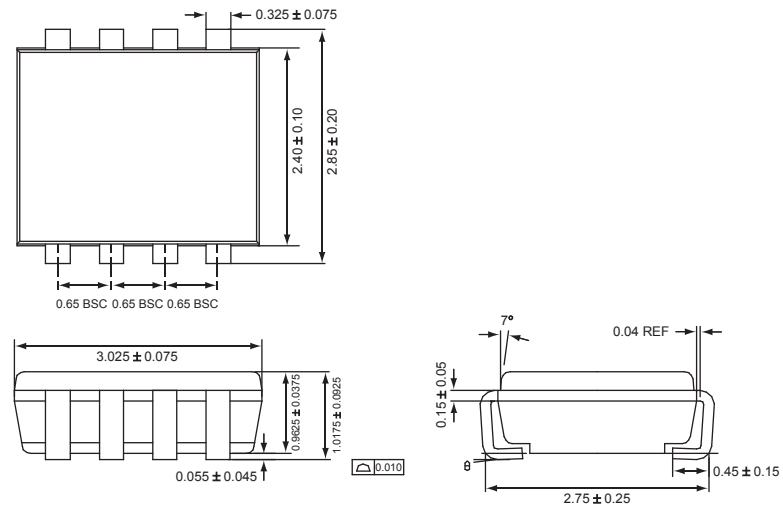

All dimensions in millimeters.

AnalogicTech cannot assume responsibility for use of any circuitry other than circuitry entirely embodied in an AnalogicTech product. No circuit patent licenses, copyrights, mask work rights, or other intellectual property rights are implied.

AnalogicTech reserves the right to make changes to their products or specifications or to discontinue any product or service without notice, and advise customers to obtain the latest version of relevant information to verify, before placing orders, that information being relied on is current and complete. All products are sold subject to the terms and conditions of sale supplied at the time of order acknowledgement, including those pertaining to warranty, patent infringement, and limitation of liability.

AnalogicTech warrants performance of its semiconductor products to the specifications applicable at the time of sale in accordance with AnalogicTech's standard warranty. Testing and other quality control techniques are utilized to the extent AnalogicTech deems necessary to support this warranty. Specific testing of all parameters of each device is not necessarily performed.

Advanced Analogic Technologies, Inc.
830 E. Arques Avenue, Sunnyvale, CA 94085
Phone (408) 737-4600
Fax (408) 737-4611

This datasheet has been download from:

www.datasheetcatalog.com

Datasheets for electronics components.