

**RADIATION HARDENED
 POWER MOSFET
 SURFACE-MOUNT (SMD-2)**

**IRHNA67164
 150V, N-CHANNEL
 R₆ TECHNOLOGY**

Product Summary

Part Number	Radiation Level	RDS(on)	Id
IRHNA67164	100K Rads (Si)	0.018Ω	56A*
IRHNA63164	300K Rads (Si)	0.018Ω	56A*

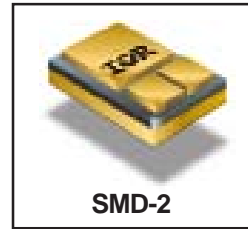

International Rectifier's R6™ technology provides superior power MOSFETs for space applications. These devices have improved immunity to Single Event Effect (SEE) and have been characterized for useful performance with Linear Energy Transfer (LET) up to 90MeV/(mg/cm²). Their combination of very low R_{DS(on)} and faster switching times reduces power loss and increases power density in today's high speed switching applications such as DC-DC converters and motor controllers. These devices retain all of the well established advantages of MOSFETs such as voltage control, ease of paralleling and temperature stability of electrical parameters.

Features:

- Low R_{DS(on)}
- Fast Switching
- Single Event Effect (SEE) Hardened
- Low Total Gate Charge
- Simple Drive Requirements
- Ease of Paralleling
- Hermetically Sealed
- Surface Mount
- Ceramic Package
- Light Weight

Absolute Maximum Ratings

Pre-Irradiation

	Parameter		Units
Id @ VGS = 12V, TC = 25°C	Continuous Drain Current	56*	A
Id @ VGS = 12V, TC = 100°C	Continuous Drain Current	49	
IDM	Pulsed Drain Current ①	224	
PD @ TC = 25°C	Max. Power Dissipation	250	W
	Linear Derating Factor	2.0	W/°C
VGS	Gate-to-Source Voltage	±20	V
EAS	Single Pulse Avalanche Energy ②	283	mJ
IAR	Avalanche Current ①	56	A
EAR	Repetitive Avalanche Energy ①	25	mJ
dv/dt	Peak Diode Recovery dv/dt ③	7.5	V/ns
TJ	Operating Junction	-55 to 150	°C
TSTG	Storage Temperature Range		
	Pckg. Mounting Surface Temp.	300 (for 5s)	
	Weight	3.3 (Typical)	g

* Current is limited by package
 For footnotes refer to the last page

Electrical Characteristics @ T_j = 25°C (Unless Otherwise Specified)

	Parameter	Min	Typ	Max	Units	Test Conditions
BV _{DSS}	Drain-to-Source Breakdown Voltage	150	—	—	V	V _{GS} = 0V, I _D = 1.0mA
ΔBV _{DSS} /ΔT _J	Temperature Coefficient of Breakdown Voltage	—	0.17	—	V/°C	Reference to 25°C, I _D = 1.0mA
R _{DS(on)}	Static Drain-to-Source On-State Resistance	—	—	0.018	Ω	V _{GS} = 12V, I _D = 49A ④
V _{GS(th)}	Gate Threshold Voltage	2.0	—	4.0	V	V _{DS} = V _{GS} , I _D = 1.0mA
g _{fs}	Forward Transconductance	50	—	—	S (⑦)	V _{DS} = 15V, I _{DS} = 49A ④
I _{DSS}	Zero Gate Voltage Drain Current	—	—	10	μA	V _{DS} = 120V, V _{GS} = 0V
		—	—	25		V _{DS} = 120V, V _{GS} = 0V, T _J = 125°C
I _{GSS}	Gate-to-Source Leakage Forward	—	—	100	nA	V _{GS} = 20V
I _{GSS}	Gate-to-Source Leakage Reverse	—	—	-100		V _{GS} = -20V
Q _g	Total Gate Charge	—	—	230	nC	V _{GS} = 12V, I _D = 56A V _{DS} = 75V
Q _{gs}	Gate-to-Source Charge	—	—	70		
Q _{gd}	Gate-to-Drain ('Miller') Charge	—	—	90		
t _{d(on)}	Turn-On Delay Time	—	—	35	ns	V _{DD} = 75V, I _D = 56A, V _{GS} = 12V, R _G = 2.35Ω
t _r	Rise Time	—	—	170		
t _{d(off)}	Turn-Off Delay Time	—	—	85		
t _f	Fall Time	—	—	35		
L _S + L _D	Total Inductance	—	2.8	—	nH	Measured from the center of drain pad to center of source pad
C _{iss}	Input Capacitance	—	7390	—	pF	V _{GS} = 0V, V _{DS} = 25V f = 1.0MHz
C _{oss}	Output Capacitance	—	1144	—		
C _{rss}	Reverse Transfer Capacitance	—	28	—		
R _g	Internal Gate Resistance	—	0.52	—		

Source-Drain Diode Ratings and Characteristics

	Parameter	Min	Typ	Max	Units	Test Conditions
I _S	Continuous Source Current (Body Diode)	—	—	56*	A	T _j = 25°C, I _S = 56A, V _{GS} = 0V ④
I _{SM}	Pulse Source Current (Body Diode) ①	—	—	224		
V _{SD}	Diode Forward Voltage	—	—	1.2	V	T _j = 25°C, I _F = 56A, di/dt ≤ 100A/μs
t _{rr}	Reverse Recovery Time	—	—	370	ns	V _{DD} ≤ 50V ④
Q _{RR}	Reverse Recovery Charge	—	—	4.5	μC	
t _{on}	Forward Turn-On Time	Intrinsic turn-on time is negligible. Turn-on speed is substantially controlled by L _S + L _D .				

* Current is limited by package

Thermal Resistance

	Parameter	Min	Typ	Max	Units	Test Conditions
R _{thJC}	Junction-to-Case	—	—	0.5	°C/W	

Note: Corresponding Spice and Saber models are available on International Rectifier Web site.

For footnotes refer to the last page

Radiation Characteristics

IRHNA67164

International Rectifier Radiation Hardened MOSFETs are tested to verify their radiation hardness capability. The hardness assurance program at International Rectifier is comprised of two radiation environments. Every manufacturing lot is tested for total ionizing dose (per notes 5 and 6) using the TO-3 package. Both pre- and post-irradiation performance are tested and specified using the same drive circuitry and test conditions in order to provide a direct comparison.

Table 1. Electrical Characteristics @ T_j = 25°C, Post Total Dose Irradiation ⑤⑥

	Parameter	Up to 300K Rads (Si)		Units	Test Conditions ⑧
		Min	Max		
BV _{DSS}	Drain-to-Source Breakdown Voltage	150	—	V	V _{GS} = 0V, I _D = 1.0mA
V _{GS(th)}	Gate Threshold Voltage	2.0	4.0		V _{GS} = V _{DS} , I _D = 1.0mA
I _{GSS}	Gate-to-Source Leakage Forward	—	100	nA	V _{GS} = 20V
I _{GSS}	Gate-to-Source Leakage Reverse	—	-100	nA	V _{GS} = -20V
I _{DSS}	Zero Gate Voltage Drain Current	—	10	μA	V _{DS} = 120V, V _{GS} = 0V
R _{DS(on)}	Static Drain-to-Source ④ On-State Resistance (TO-3)	—	0.019	Ω	V _{GS} = 12V, I _D = 49A
R _{DS(on)}	Static Drain-to-Source ④ On-State Resistance (SMD-2)	—	0.018	Ω	V _{GS} = 12V, I _D = 49A
V _{SD}	Diode Forward Voltage ④	—	1.2	V	V _{GS} = 0V, I _D = 56A

Part numbers IRHNA67164 and IRHNA63164

International Rectifier radiation hardened MOSFETs have been characterized in heavy ion environment for Single Event Effects (SEE). Single Event Effects characterization is illustrated in Fig. a and Tables.

Tables for Single Event Effect Safe Operating Area

Ion Kr LET = 39 MeV/(mg/cm ²) Energy = 312 MeV Range = 39 μm	
VGS Bias (Volts)	VDS Bias (Volts)
0	150
-5	150
-10	150
-15	150
-20	150

Ion Xe LET = 59 MeV/(mg/cm ²) Energy = 825 MeV Range = 66 μm	
VGS Bias (Volts)	VDS Bias (Volts)
0	150
-5	150
-9	150
-10	140
-11	50
-15	40

Ion Au LET = 90 MeV/(mg/cm ²) Energy = 1480 MeV Range = 80 μm	
VGS Bias (Volts)	VDS Bias (Volts)
0	50
-5	50
-10	30

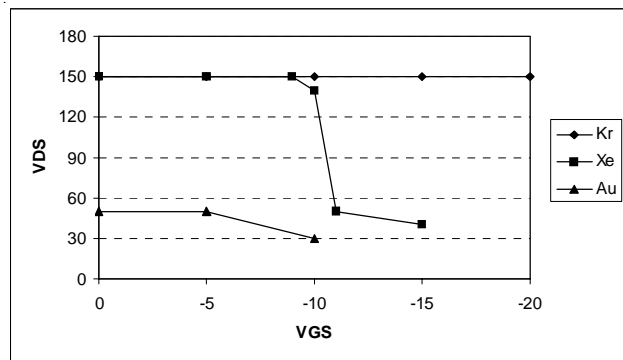

Fig a. Single Event Effect, Safe Operating Area

For footnotes refer to the last page

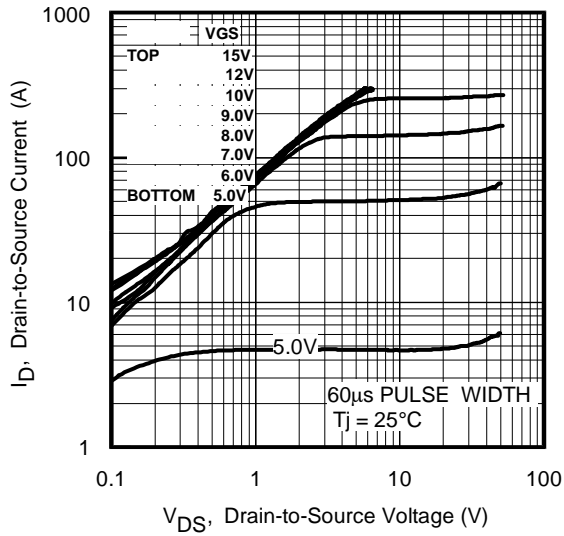

Fig 1. Typical Output Characteristics

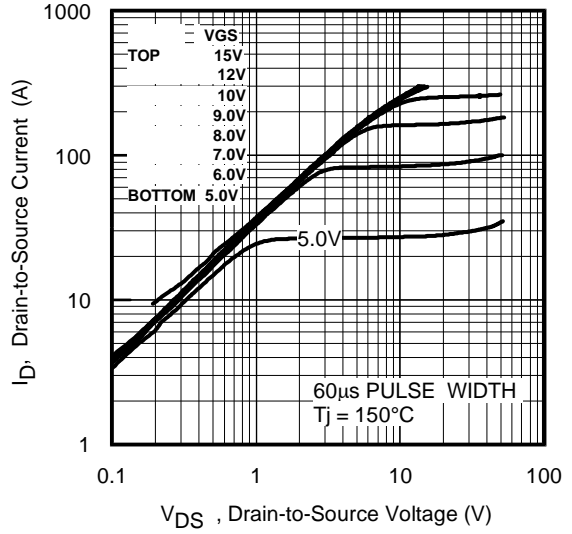

Fig 2. Typical Output Characteristics

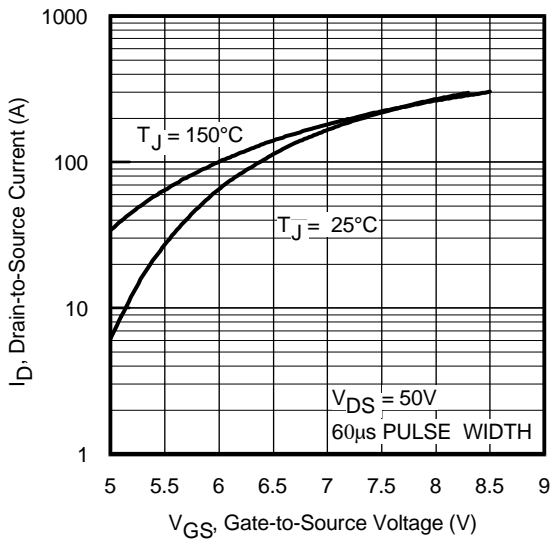

Fig 3. Typical Transfer Characteristics

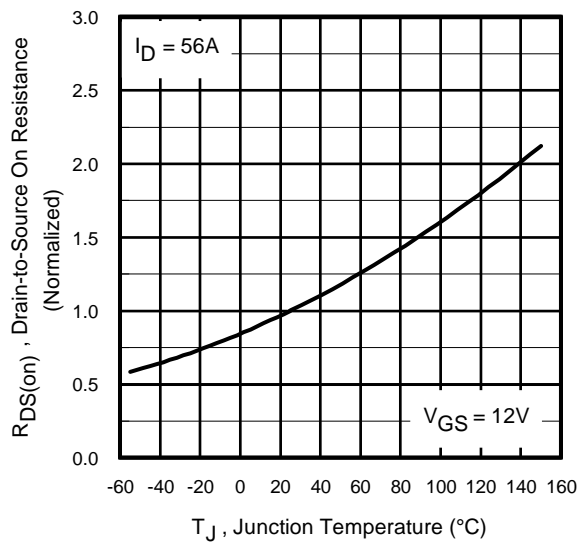

Fig 4. Normalized On-Resistance Vs. Temperature

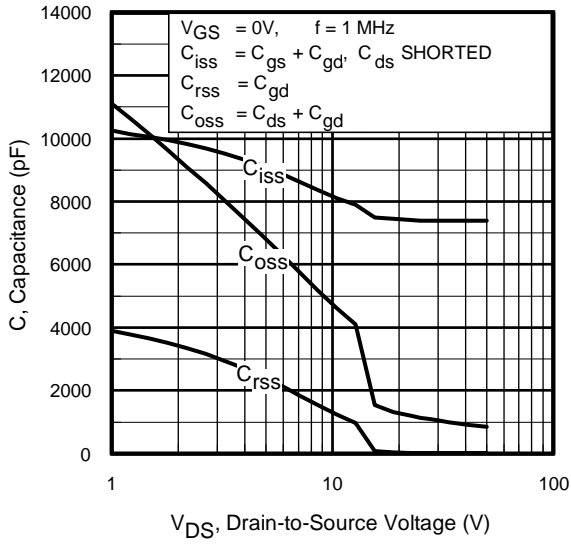

Fig 5. Typical Capacitance Vs. Drain-to-Source Voltage

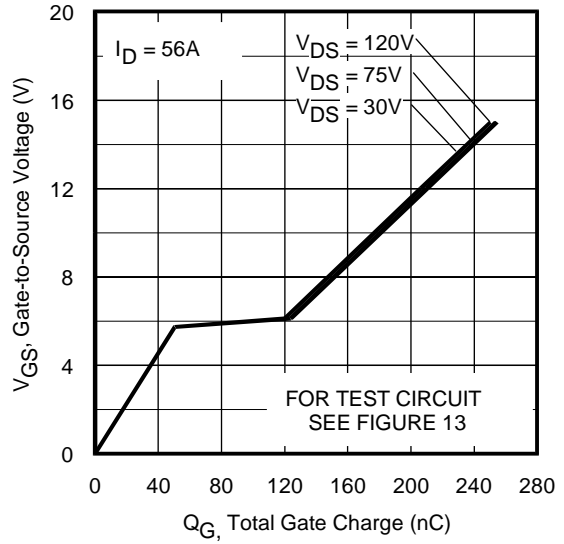

Fig 6. Typical Gate Charge Vs. Gate-to-Source Voltage

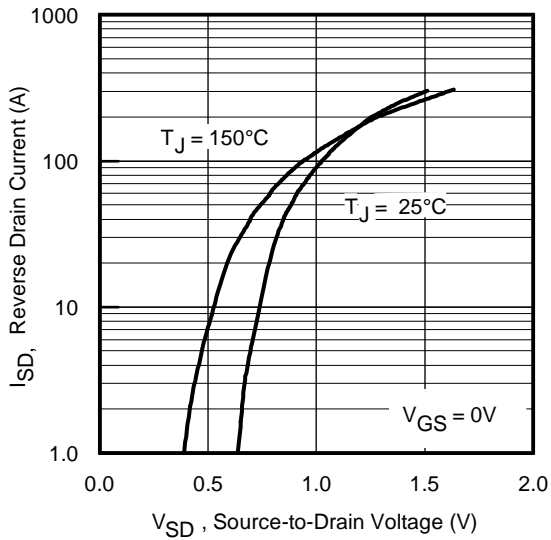

Fig 7. Typical Source-Drain Diode Forward Voltage

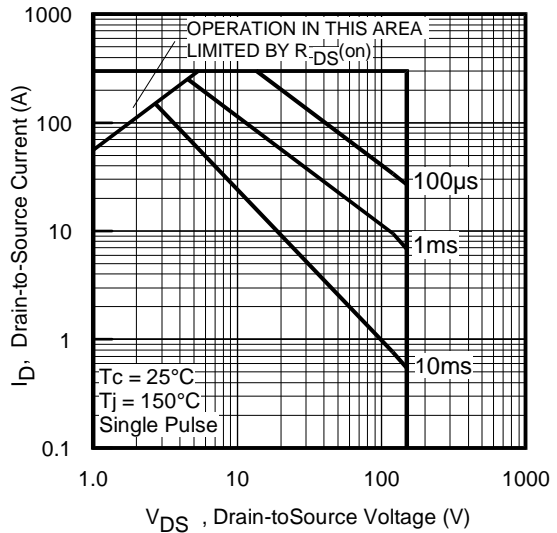

Fig 8. Maximum Safe Operating Area

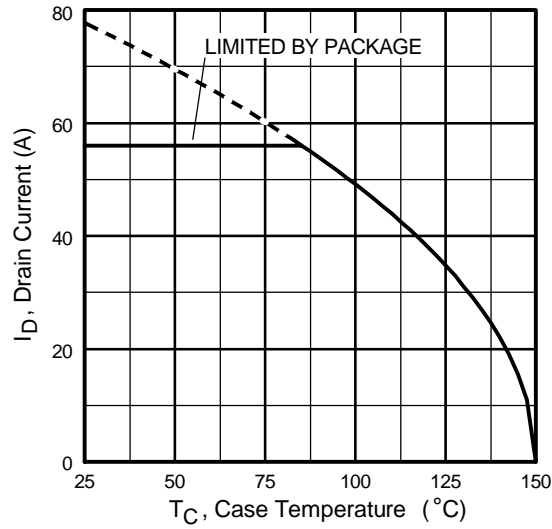

Fig 9. Maximum Drain Current Vs. Case Temperature

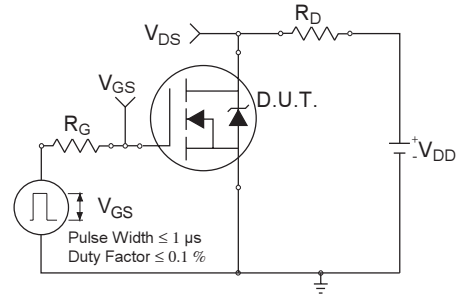

Fig 10a. Switching Time Test Circuit

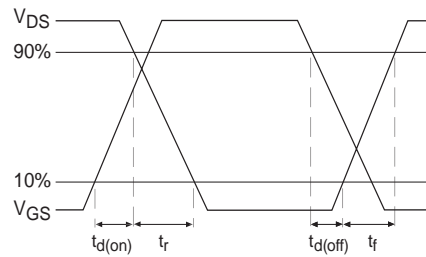

Fig 10b. Switching Time Waveforms

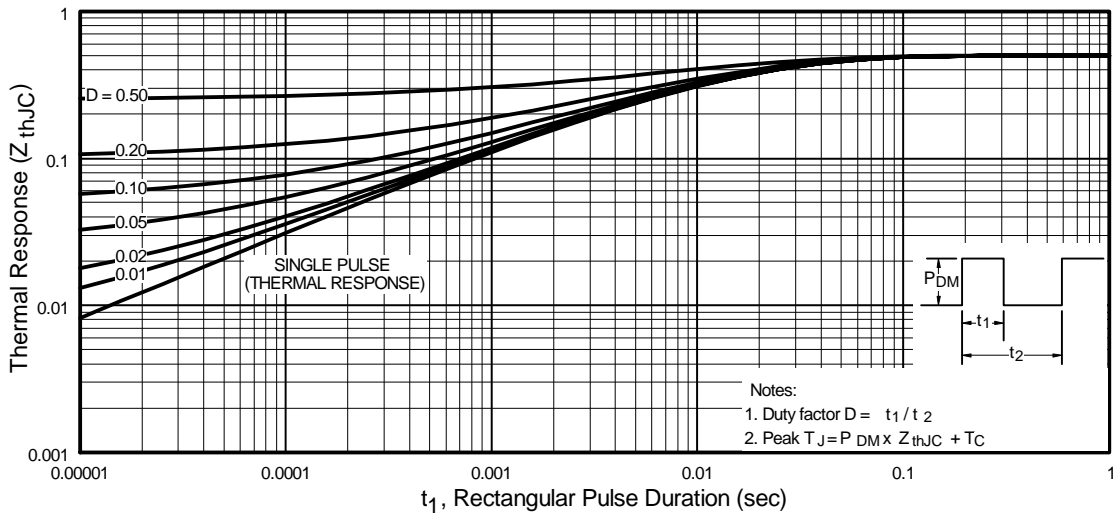

Fig 11. Maximum Effective Transient Thermal Impedance, Junction-to-Case

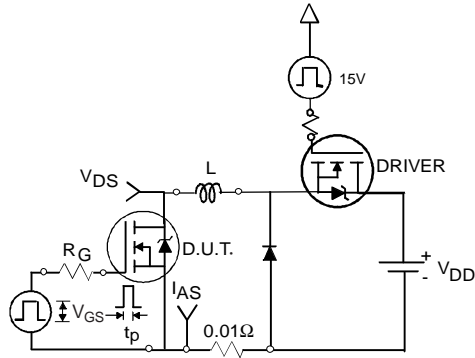

Fig 12a. Unclamped Inductive Test Circuit

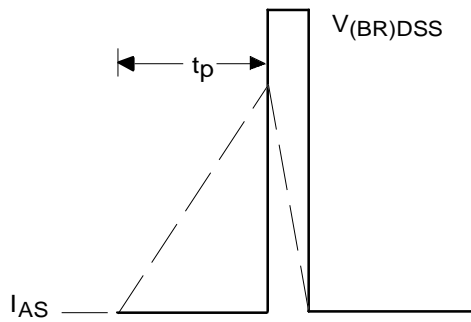

Fig 12b. Unclamped Inductive Waveforms

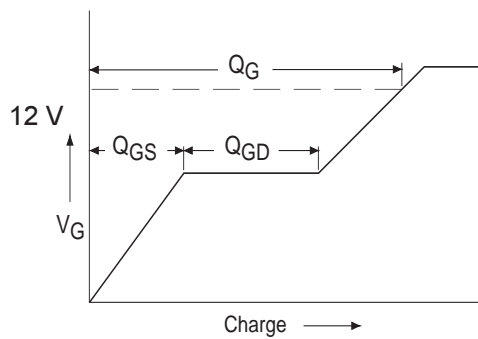

Fig 13a. Basic Gate Charge Waveform

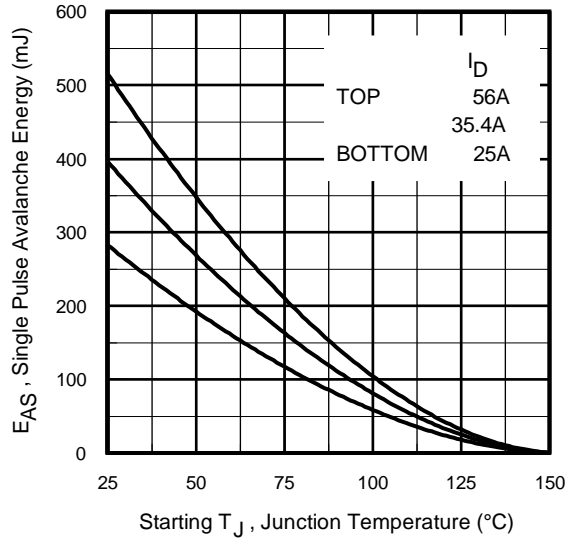

Fig 12c. Maximum Avalanche Energy Vs. Drain Current

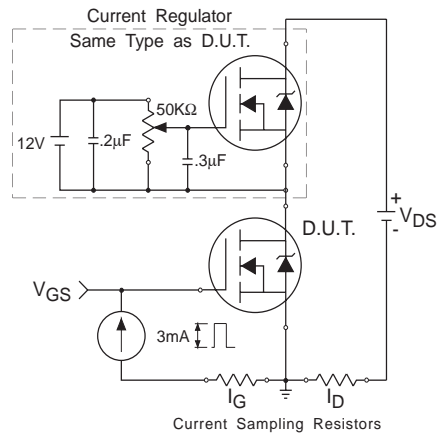

Fig 13b. Gate Charge Test Circuit

