

**N-CHANNEL ENHANCEMENT MODE FIELD EFFECT TRANSISTOR**

NEW PRODUCT

**Features**

- Low On-Resistance:  $R_{DS(ON)}$
- Low Gate Threshold Voltage
- Low Input Capacitance
- Fast Switching Speed
- Low Input/Output Leakage
- **Lead Free By Design/RoHS Compliant (Note 2)**
- **ESD Protected up to 2KV**
- "Green" Device (Note 4)
- **Qualified to AEC-Q101 standards for High Reliability**

**Mechanical Data**

- Case: SOT-323
- Case Material: Molded Plastic, "Green" Molding Compound. UL Flammability Classification Rating 94V-0
- Moisture sensitivity: Level 1 per J-STD-020C
- Terminals: Finish — Matte Tin annealed over Alloy 42 leadframe. Solderable per MIL-STD-202, Method 208
- Terminal Connections: See Diagram
- Marking: See Last Page
- Ordering & Date Code Information: See Last Page
- Weight: 0.006 grams (approximate)

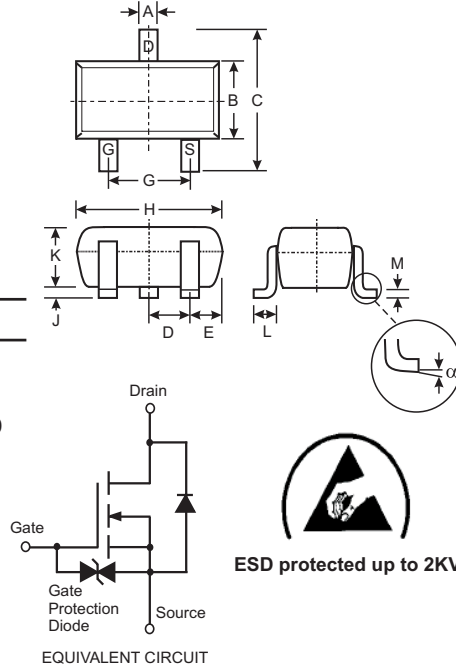

SOT-323		
Dim	Min	Max
A	0.25	0.40
B	1.15	1.35
C	2.00	2.20
D	0.65 Nominal	
E	0.30	0.40
G	1.20	1.40
H	1.80	2.20
J	0.0	0.10
K	0.90	1.00
L	0.25	0.40
M	0.10	0.18
$\alpha$	0°	8°
All Dimensions in mm		

**Maximum Ratings** @  $T_A = 25^\circ\text{C}$  unless otherwise specified

Characteristic		Symbol	Value	Units
Drain-Source Voltage		$V_{DSS}$	20	V
Gate-Source Voltage		$V_{GSS}$	$\pm 8$	V
Drain Current (Note 1)	Steady State	$I_D$	$T_A = 25^\circ\text{C}$	540
			$T_A = 85^\circ\text{C}$	390
Pulsed Drain Current (Note 3)		$I_{DM}$	1.5	A
Total Power Dissipation (Note 1)		$P_d$	200	mW
Thermal Resistance, Junction to Ambient		$R_{\theta JA}$	625	$^\circ\text{C/W}$
Operating and Storage Temperature Range		$T_j, T_{STG}$	-65 to +150	$^\circ\text{C}$

- Note:
1. Device mounted on FR-4 PCB.
  2. No purposefully added lead.
  3. Pulse width  $\leq 10\mu\text{s}$ , Duty Cycle  $\leq 1\%$ .
  4. Diodes Inc.'s "Green" policy can be found on our website at [http://www.diodes.com/products/lead\\_free/index.php](http://www.diodes.com/products/lead_free/index.php).

**Electrical Characteristics** @  $T_A = 25^\circ\text{C}$  unless otherwise specified

Characteristic	Symbol	Min	Typ	Max	Unit	Test Condition
<b>OFF CHARACTERISTICS (Note 5)</b>						
Drain-Source Breakdown Voltage	$BV_{DSS}$	20	—	—	V	$V_{GS} = 0V, I_D = 10\mu A$
Zero Gate Voltage Drain Current	$I_{DSS}$	—	—	1	$\mu A$	$V_{DS} = 16V, V_{GS} = 0V$
Gate-Source Leakage	$I_{GSS}$	—	—	$\pm 1$	$\mu A$	$V_{GS} = \pm 4.5V, V_{DS} = 0V$
<b>ON CHARACTERISTICS (Note 5)</b>						
Gate Threshold Voltage	$V_{GS(th)}$	0.5	—	1.0	V	$V_{DS} = V_{GS}, I_D = 250\mu A$
Static Drain-Source On-Resistance	$R_{DS(on)}$	—	0.4	0.55	$\Omega$	$V_{GS} = 4.5V, I_D = 540mA$
			0.5	0.70		$V_{GS} = 2.5V, I_D = 500mA$
			0.7	0.9		$V_{GS} = 1.8V, I_D = 350mA$
Forward Transfer Admittance	$ Y_{fs} $	200	—	—	ms	$V_{DS} = 10V, I_D = 0.2A$
Diode Forward Voltage (Note 5)	$V_{SD}$	0.5	—	1.4	V	$V_{GS} = 0V, I_S = 115mA$
<b>DYNAMIC CHARACTERISTICS</b>						
Input Capacitance	$C_{iss}$	—	—	150	pF	$V_{DS} = 16V, V_{GS} = 0V$ $f = 1.0MHz$
Output Capacitance	$C_{oss}$	—	—	25	pF	
Reverse Transfer Capacitance	$C_{rss}$	—	—	20	pF	

Notes: 5. Short duration test pulse used to minimize self-heating effect.

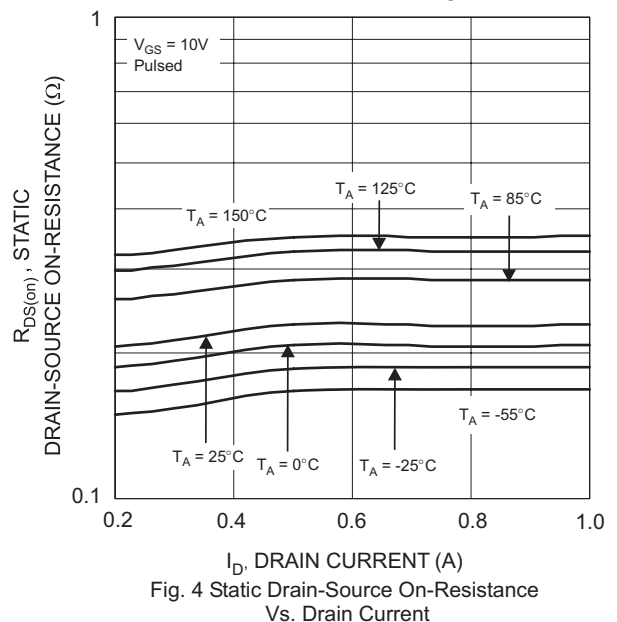
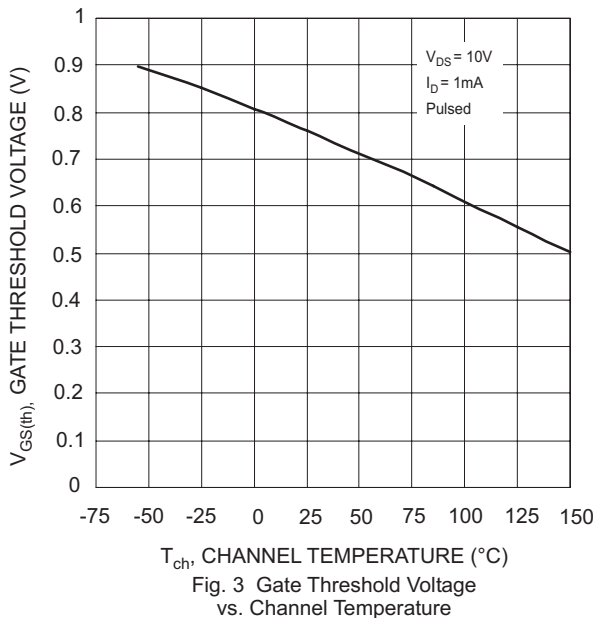
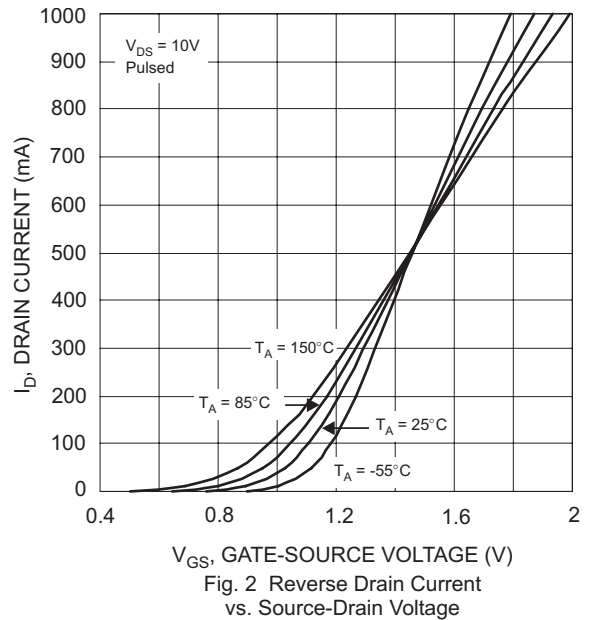
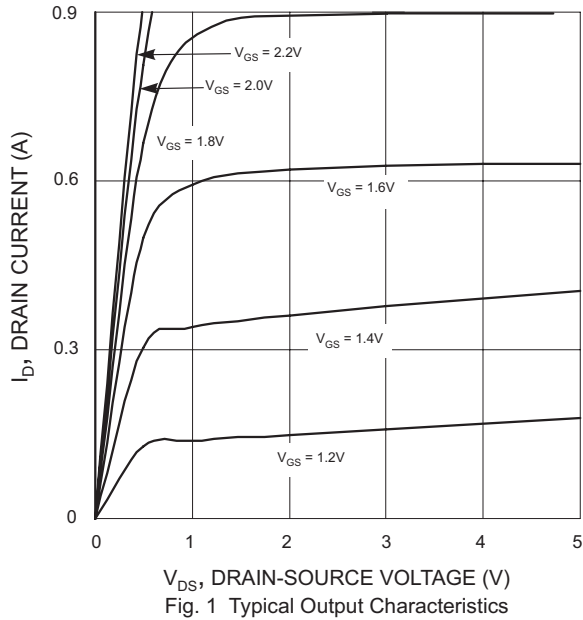

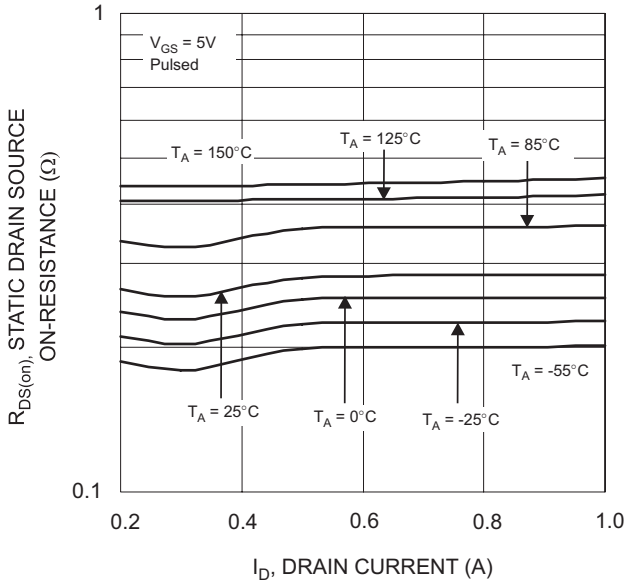

Fig. 5 Static Drain-Source On-Resistance vs. Drain Current

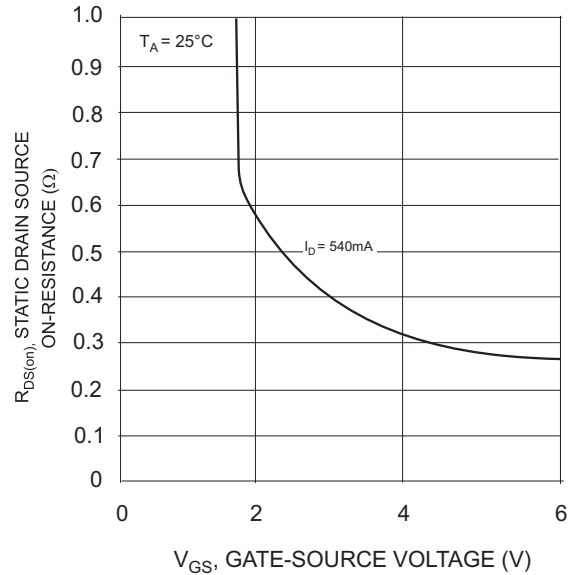

Fig. 6 Static Drain-Source, On-Resistance vs. Gate-Source Voltage

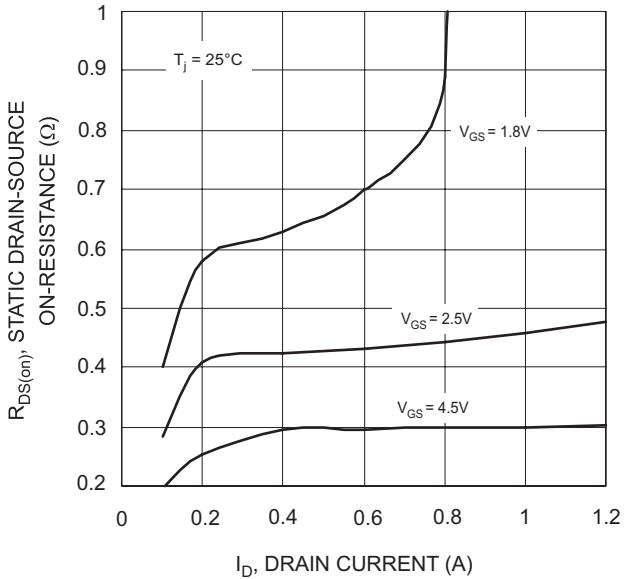

Fig. 7 On-Resistance vs. Drain Current and Gate Voltage

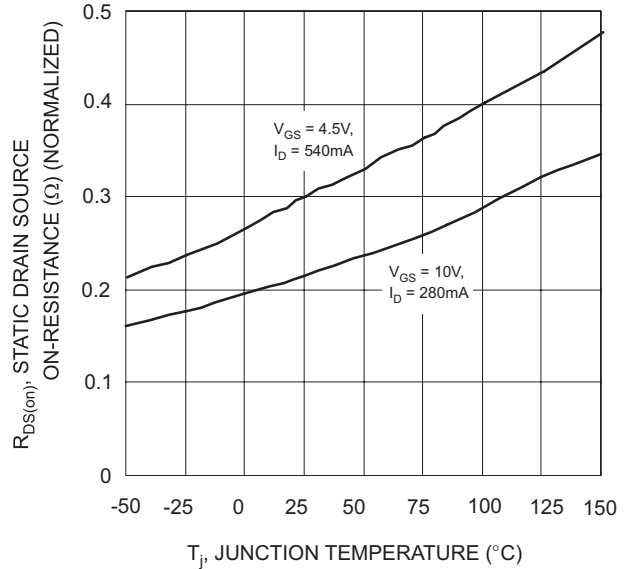

Fig. 8 Static Drain-Source, On-Resistance vs. Temperature

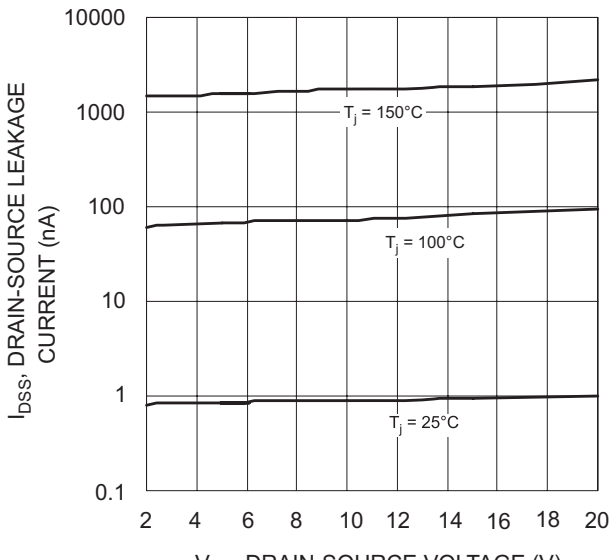

Fig. 9 Drain Source Leakage Current vs. Voltage

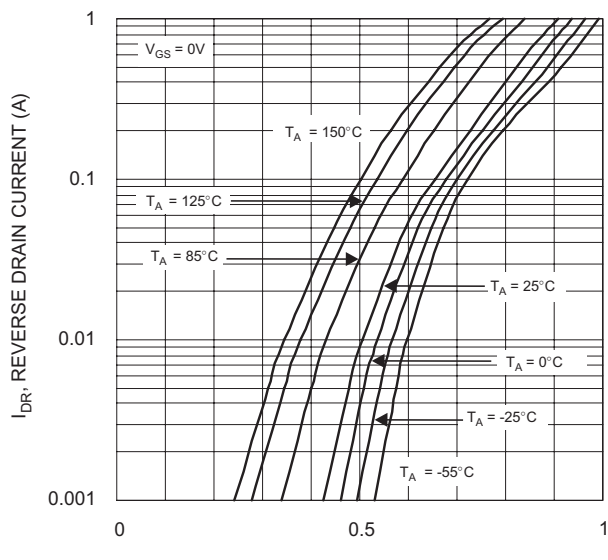

Fig. 10 Reverse Drain Current vs. Source-Drain Voltage

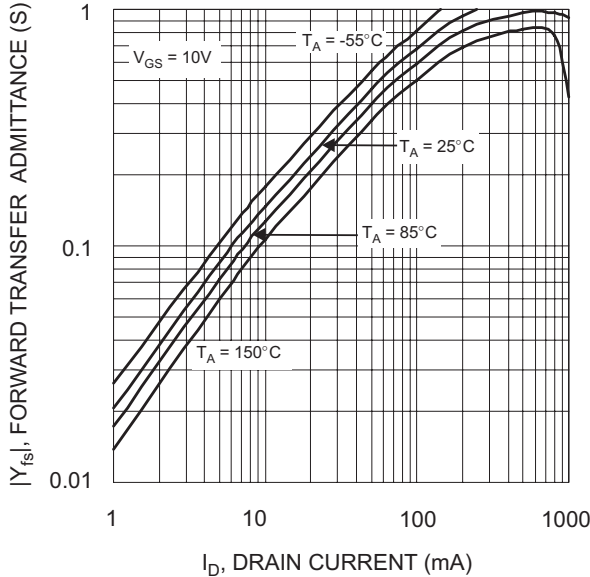

Fig. 11 Forward Transfer Admittance vs. Drain Current

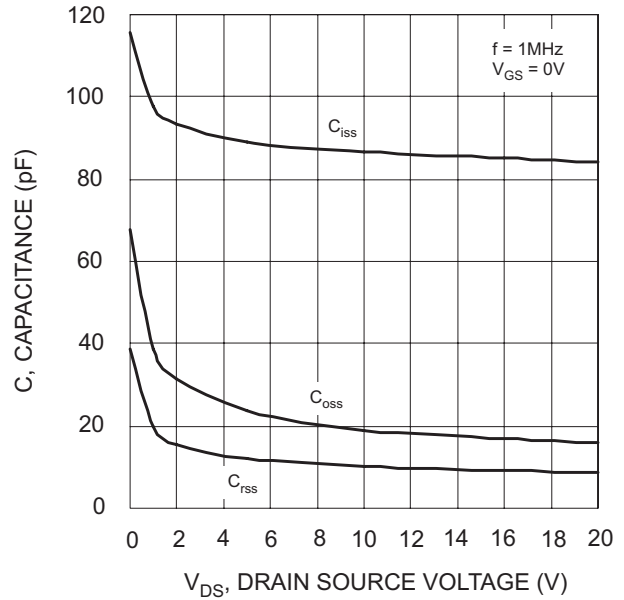

Fig. 12 Capacitance Variation

**Ordering Information** (Note 6)

Device	Packaging	Shipping
DMN2004WK-7	SOT-323	3000/Tape & Reel

Notes: 6. For Packaging Details, go to our website at <http://www.diodes.com/datasheets/ap02007.pdf>.

**Marking Information**

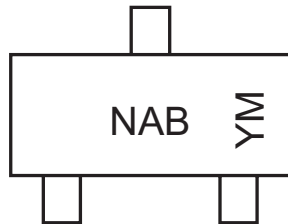

NAB = Product Type Marking Code  
 YM = Date Code Marking  
 Y = Year ex: T = 2006  
 M = Month ex: 9 = September

Date Code Key

Year	2006			2007			2008			2009		
Code	T			U			V			W		
Month	Jan	Feb	Mar	Apr	May	Jun	Jul	Aug	Sep	Oct	Nov	Dec
Code	1	2	3	4	5	6	7	8	9	O	N	D

**IMPORTANT NOTICE**

Diodes Incorporated and its subsidiaries reserve the right to make modifications, enhancements, improvements, corrections or other changes without further notice to any product herein. Diodes Incorporated does not assume any liability arising out of the application or use of any product described herein; neither does it convey any license under its patent rights, nor the rights of others. The user of products in such applications shall assume all risks of such use and will agree to hold Diodes Incorporated and all the companies whose products are represented on our website, harmless against all damages.

**LIFE SUPPORT**

Diodes Incorporated products are not authorized for use as critical components in life support devices or systems without the expressed written approval of the President of Diodes Incorporated.