

TABLE OF CONTENTS

Specifications.....	3	Laser Control	13
SFP Timing Specifications.....	5	Control Methods	13
Absolute Maximum Ratings.....	6	Voltage Setpoint Calibration.....	13
Temperature Specifications	6	Resistor Setpoint Calibration.....	15
ESD Caution.....	6	IMPD Monitoring	15
Pin Configuration and Function Descriptions.....	7	Loop Bandwidth Selection.....	16
Optical Waveforms	8	Power Consumption	16
Multirate Performance Using Low Cost Fabry Perot Tosa NEC NX7315UA	8	Automatic Laser Shutdown (Tx_Disable)	16
Performance Over Temperature Using DFB Tosa SUMITOMO SLT2486.....	8	Bias and Modulation Monitor Currents.....	16
Typical Performance Characteristics	9	Data Inputs.....	17
Single-Ended Output	9	Laser Diode Interfacing.....	17
Differential Output.....	10	Alarms.....	18
Performance Characteristics.....	11	Outline Dimensions	19
Theory of Operation	13	Ordering Guide	19

REVISION HISTORY**6/05—Revision 0: Initial Version**

SPECIFICATIONS

$V_{CC} = 3.0\text{ V to }3.6\text{ V}$. All specifications T_{MIN} to T_{MAX}^1 , unless otherwise noted. Typical values as specified at 25°C .

Table 1.

Parameter	Min	Typ	Max	Unit	Conditions/Comments
LASER BIAS CURRENT (IBIAS)					
Output Current IBIAS	2		100	mA	
Compliance Voltage	1.2		V_{CC}	V	
IBIAS when ALS is High			0.1	mA	
MODULATION CURRENT (IMODP, IMODN) ²					
Output Current IMOD	5		90	mA	
Compliance Voltage	1.5		V_{CC}	V	
IMOD when ALS is High			0.1	mA	5 mA < IMOD < 90 mA
Rise Time Single-Ended Output ^{2,3}		60	104	ps	5 mA < IMOD < 90 mA
Fall Time Single-Ended Output ^{2,3}		60	96	ps	5 mA < IMOD < 90 mA
Random Jitter Single-Ended Output ^{2,3}		0.8	1.1	ps (rms)	5 mA < IMOD < 90 mA
Deterministic Jitter Single-Ended Output ^{3,4}		19	35	ps	20 mA < IMOD < 90 mA
Pulse-Width Distortion ^{2,3} Single-Ended Output		21	30	ps	20 mA < IMOD < 90 mA
Rise Time Differential Output ^{3,5}		47.1		ps	5 mA < IMOD < 30 mA
Fall Time Differential Output ^{3,5}		46		ps	5 mA < IMOD < 30 mA
Random Jitter Differential Output ^{3,5}		0.64		ps (rms)	5 mA < IMOD < 30 mA
Deterministic Jitter Differential Output ^{3,6}		12		ps	5 mA < IMOD < 30 mA
Pulse-Width Distortion Differential Output ^{3,5}		2.1		ps	5 mA < IMOD < 30 mA
Rise Time Differential Output ^{3,5}		56		ps	5 mA < IMOD < 90 mA
Fall Time Differential Output ^{3,5}		55		ps	5 mA < IMOD < 90 mA
Random Jitter Differential Output ^{3,5}		0.61		ps (rms)	5 mA < IMOD < 90 mA
Deterministic Jitter Differential Output ^{3,7}		17		ps	5 mA < IMOD < 90 mA
Pulse Width Distortion Differential Output ^{3,5}		1.6		ps	5 mA < IMOD < 90 mA
AVERAGE POWER SET (PAVSET)					
Pin Capacitance			80	pF	
Voltage	1.1	1.2	1.3	V	
Photodiode Monitor Current (Average Current)	50		1200	μA	Resistor setpoint mode
EXTINCTION RATIO SET INPUT (ERSET)					
Resistance Range	1.5		25	k Ω	Resistor setpoint mode
Resistance Range	0.99	1	1.01	k Ω	Voltage setpoint mode
AVERAGE POWER REFERENCE VOLTAGE INPUT (PAVREF)					
Voltage Range	0.07		1	V	Voltage setpoint mode (RPAV fixed at 1 k Ω)
Photodiode Monitor Current (Average Current)	70		1000	μA	Voltage setpoint mode (RPAV fixed at 1 k Ω)
EXTINCTION RATIO REFERENCE VOLTAGE INPUT (ERREF)					
Voltage Range	0.05		0.9	V	Voltage setpoint mode (RERSET fixed at 1 k Ω)
ERREF Voltage to IMOD Gain		100		mA/V	
DATA INPUTS (DATAP, DATAN) ⁸					
V p-p (Differential)	0.4		2.4	V	AC-coupled
Input Impedance (Single-Ended)		50		Ω	
LOGIC INPUTS (ALS)					
V_{IH}	2			V	
V_{IL}			0.8	V	

ADN2871

Parameter	Min	Typ	Max	Unit	Conditions/Comments
ALARM OUTPUT (FAIL) ⁹					
V_{OFF}		>1.8		V	Voltage required at FAIL for IBIAS and IMOD to turn off when FAIL asserted
V_{ON}		<1.3		V	Voltage required at FAIL for IBIAS and IMOD to stay on when FAIL asserted
IBMON, IMON DIVISION RATIO					
IBIAS/IBMON ³	76	94	112	A/A	2 mA < IBIAS < 11 mA
IBIAS/IBMON ³	85	100	115	A/A	11 mA < IBIAS < 50 mA
IBIAS/IBMON ³	92	100	108	A/A	50 mA < IBIAS < 100 mA
IBIAS/IBMON STABILITY ^{3,10}			±5	%	10 mA < IBIAS < 100 mA
IMOD/IMON		42		A/A	
IBMON Compliance Voltage	0		1.3	V	
SUPPLY					
I_{CC} ¹¹		32		mA	When IBIAS = IMOD = 0
V_{CC} (with respect to GND) ¹²	3.0	3.3	3.6	V	

¹ Temperature range: -40°C to +85°C.

² Measured into a single-ended 15 Ω load (22 Ω resistor in parallel with digital scope 50 Ω input) using a 1111111100000000 pattern at 2.5 Gbps, shown in Figure 2.

³ Guaranteed by design and characterization. Not production tested.

⁴ Measured into a single-ended 15 Ω load using a K28.5 pattern at 2.5 Gbps, shown in Figure 2.

⁵ Measured into a differential 30 Ω (43 Ω differential resistor in parallel with a digital scope of 50 Ω input) load using a 1111111100000000 pattern at 4.25 Gbps, as shown in Figure 3.

⁶ Measured into a differential 30 Ω load using a K28.5 pattern at 4.25 Gbps, as shown in Figure 3.

⁷ Measured into a differential 30 Ω load using a K28.5 pattern at 2.7Gbps, as shown in Figure 3.

⁸ When the voltage on DATAP is greater than the voltage on DATAN, the modulation current flows in the IMODP pin.

⁹ Guaranteed by design. Not production tested.

¹⁰ IBIAS/IBMON ratio stability is defined in SFF-8472 Revision 9 over temperature and supply variation.

¹¹ See the I_{CC} minimum for power calculation in the Power Consumption section.

¹² All V_{CC} pins should be shorted together.

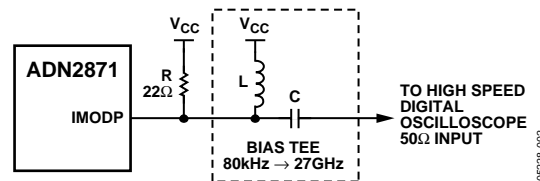

Figure 2. High Speed Electrical Test Single-Ended Output Circuit

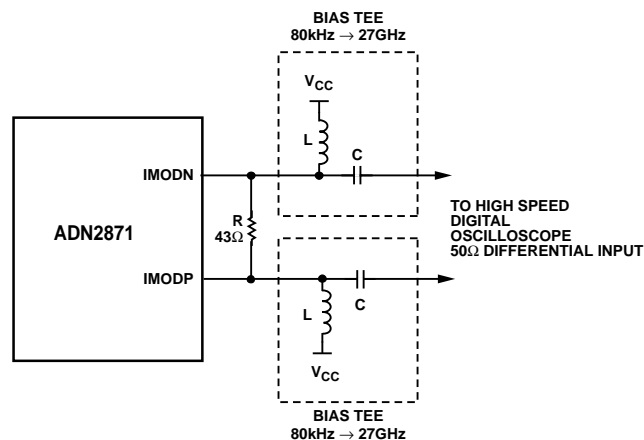

Figure 3. High Speed Electrical Test Differential Output Circuit

SFP TIMING SPECIFICATIONS

Table 2.

Parameter	Symbol	Min	Typ	Max	Unit	Conditions/Comments
ALS Assert Time	t_off		1	5	μs	Time for the rising edge of ALS (Tx_DISABLE) to when the bias current falls below 10% of nominal.
ALS Negate Time ¹	t_on		0.15	0.4	ms	Time for the falling edge of ALS to when the modulation current rises above 90% of nominal.
Time to Initialize, Including Reset of FAIL ¹	t_init		25	275	ms	From power-on or negation of FAIL using ALS.
FAIL Assert Time	t_fault			100	μs	Time to fault to FAIL on.
ALS to Reset Time	t_reset			5	μs	Time Tx_DISABLE must be held high to reset Tx_FAULT.

¹ Guaranteed by design and characterization. Not production tested.

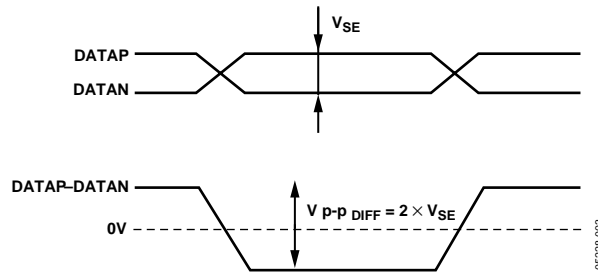

Figure 4. Signal Level Definition

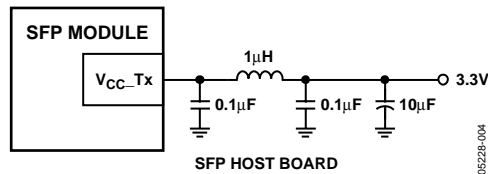

Figure 5. Recommended SFP Supply

ABSOLUTE MAXIMUM RATINGS

Table 3.

Parameter	Rating
V _{CC} to GND	4.2 V
IMODN, IMODP	-0.3 V to +4.8 V
All Other Pins	-0.3 to 3.9 V
Junction Temperature	150°C

Stresses above those listed under Absolute Maximum Ratings may cause permanent damage to the device. This is a stress rating only; functional operation of the device at these or any other conditions above those listed in the operational sections of this specification is not implied. Exposure to absolute maximum rating conditions for extended periods may affect device reliability.

TEMPERATURE SPECIFICATIONS

Table 4.

Parameter	Rating
Operating Temperature Range	
Industrial	-40°C to +85°C
Storage Temperature Range	-65°C to +150°C
Junction Temperature (T _J max)	125°C
LFCSP	
Power Dissipation ¹	(T _J max - T _A)/θ _{JA} W
θ _{JA} Thermal Impedance ²	30°C/W
θ _{JC} Thermal Impedance	29.5°C/W
Lead Temperature (Soldering 10 sec)	300°C

¹ Power consumption equations are provided in the Power Consumption section.

² θ_{JA} is defined when part is soldered on a 4-layer board.

ESD CAUTION

ESD (electrostatic discharge) sensitive device. Electrostatic charges as high as 4000 V readily accumulate on the human body and test equipment and can discharge without detection. Although this product features proprietary ESD protection circuitry, permanent damage may occur on devices subjected to high energy electrostatic discharges. Therefore, proper ESD precautions are recommended to avoid performance degradation or loss of functionality.



PIN CONFIGURATION AND FUNCTION DESCRIPTIONS

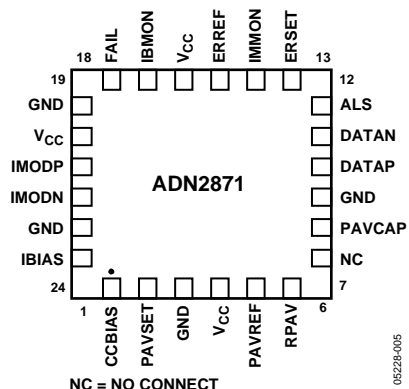

Figure 6. Pin Configuration—Top View

Note: The LFCSP has an exposed paddle that must be connected to ground.

Table 5. Pin Function Descriptions

Pin No.	Mnemonic	Description
1	CCBIAS	Connect to IBIAS, Pin 24
2	PAVSET	Average Optical Power Set Pin
3	GND	Supply Ground
4	V _{CC}	Supply Voltage
5	PAVREF	Reference Voltage Input for Average Optical Power Control
6	RPAV	Average Power Resistor when Using PAVREF
7	NC	No Connect
8	PAVCAP	Average Power Loop Capacitor
9	GND	Supply Ground
10	DATAP	Data, Positive Differential Input
11	DATAN	Data, Negative Differential Input
12	ALS	Automatic Laser Shutdown
13	ERSET	Extinction Ratio Set Pin
14	IMMON	Modulation Current Monitor Current Source
15	ERREF	Reference Voltage Input for Extinction Ratio Control
16	V _{CC}	Supply Voltage
17	IBMON	Bias Current Monitor Current Source
18	FAIL	FAIL Alarm Output
19	GND	Supply Ground
20	V _{CC}	Supply Voltage
21	IMODP	Modulation Current Positive Output; connect to laser diode
22	IMODN	Modulation Current Negative Output
23	GND	Supply Ground
24	IBIAS	Laser Diode Bias (Current Sink to Ground)

OPTICAL WAVEFORMS

$V_{CC} = 3.3\text{ V}$ and $T_A = 25^\circ\text{C}$, unless otherwise noted.

MULTIRATE PERFORMANCE USING LOW COST FABRY PEROT TOSA NEC NX7315UA

Note: No change to PAVCAP and ERCAP values.

(ACQ LIMIT TEST) WAVEFORMS 1000

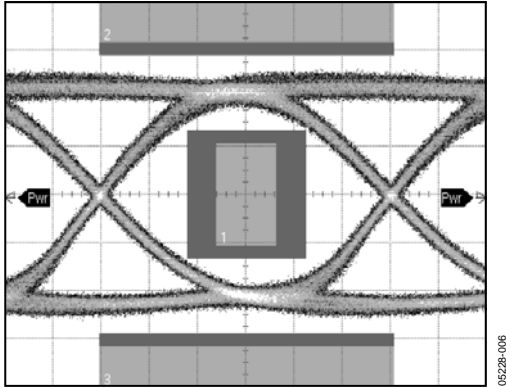

Figure 7. Optical Eye 2.488 Gbps, 65 ps/div, PRBS $2^{31}-1$
PAV = -4.5 dBm, ER = 9 dB, Mask Margin 25%

(ACQ LIMIT TEST) WAVEFORMS 1000

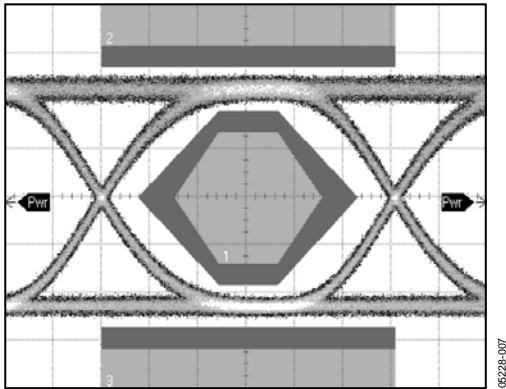

Figure 8. Optical Eye 622 Mbps, 264 ps/div, PRBS $2^{31}-1$
PAV = -4.5 dBm, ER = 9 dB, Mask Margin 50%

(ACQ LIMIT TEST) WAVEFORMS 1000

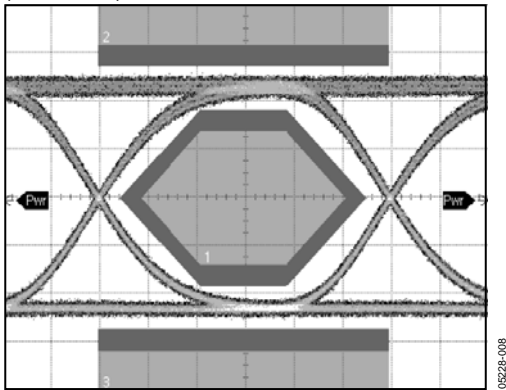

Figure 9. Optical Eye 155 Mbps, 1.078 ns/div, PRBS $2^{31}-1$
PAV = -4.5 dBm, ER = 9 dB, Mask Margin 50%

PERFORMANCE OVER TEMPERATURE USING DFB TOSA SUMITOMO SLT2486

(ACQ LIMIT TEST) WAVEFORMS 1001

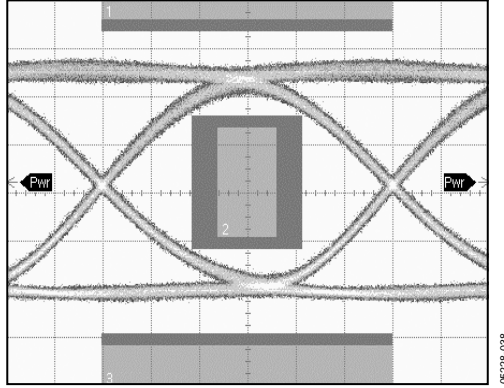

Figure 10. Optical Eye 2.488 Gbps, 65 ps/div, PRBS $2^{31}-1$
PAV = 0 dBm, ER = 9 dB, Mask Margin 22%, $T_A = 25^\circ\text{C}$

(ACQ LIMIT TEST) WAVEFORMS 1001

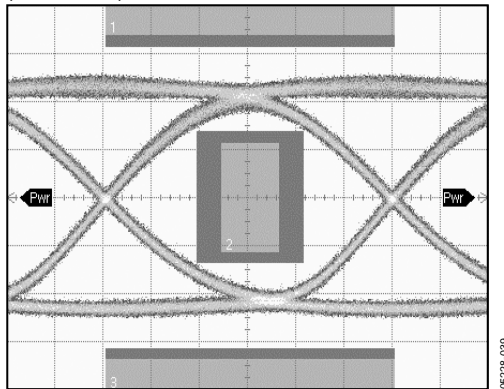

Figure 11. Optical Eye 2.488 Gbps, 65 ps/div, PRBS $2^{31}-1$
PAV = -0.2 dBm, ER = 8.96 dB, Mask Margin 21%, $T_A = 85^\circ\text{C}$

TYPICAL PERFORMANCE CHARACTERISTICS

SINGLE-ENDED OUTPUT

These performance characteristics were measured using the high speed electrical single-ended output circuit shown in Figure 2.

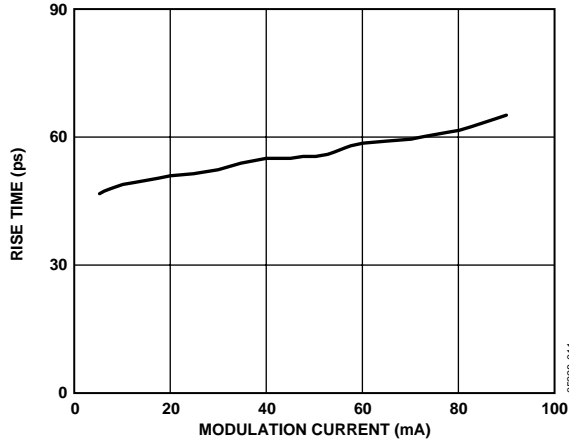

Figure 12. Rise Time vs. Modulation Current, $I_{BIAS} = 20$ mA

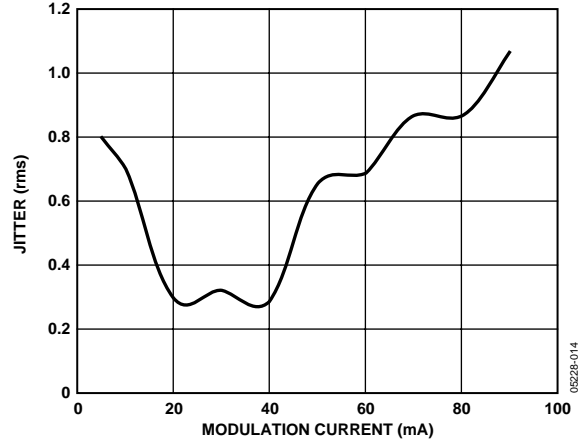

Figure 14. Random Jitter vs. Modulation Current, $I_{BIAS} = 20$ mA

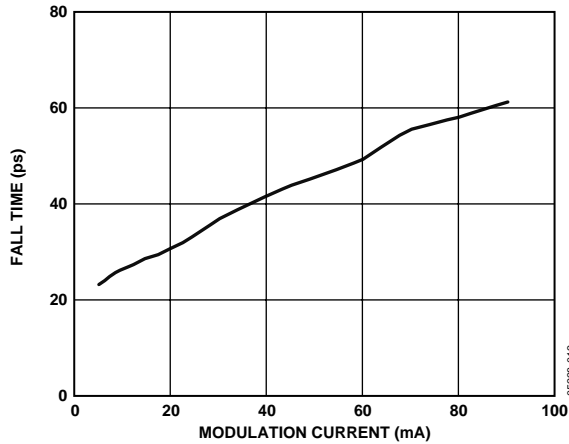

Figure 13. Fall Time vs. Modulation Current, $I_{BIAS} = 20$ mA

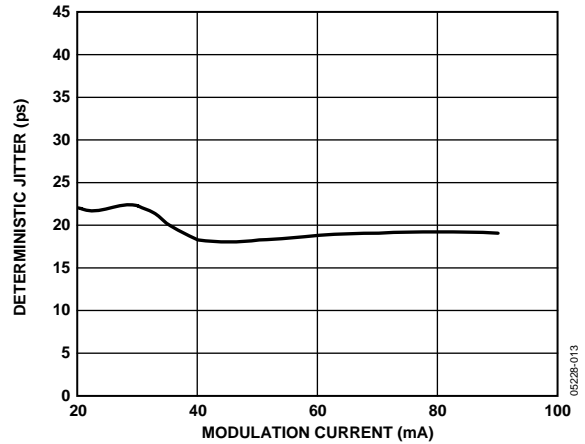

Figure 15. Deterministic Jitter at 2.488 Gbps vs. Modulation Current, $I_{BIAS} = 20$ mA

DIFFERENTIAL OUTPUT

These performance characteristics were measured using the high speed electrical differential output circuit shown in Figure 3.

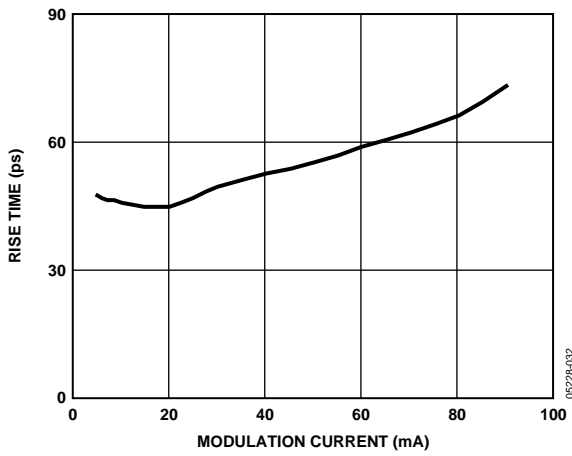

Figure 16. Rise Time vs. Modulation Current, $I_{BIAS} = 20$ mA

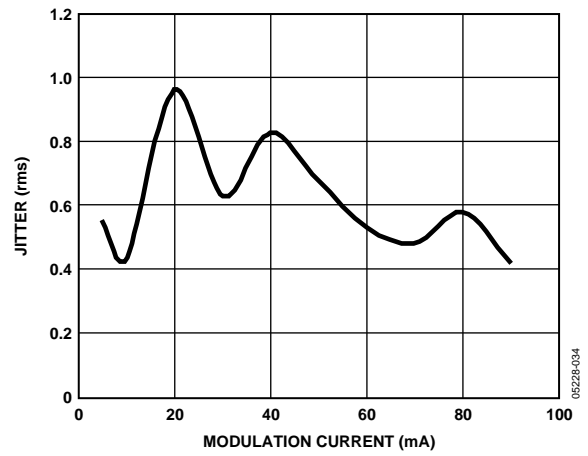

Figure 18. Random Jitter vs. Modulation Current, $I_{BIAS} = 20$ mA

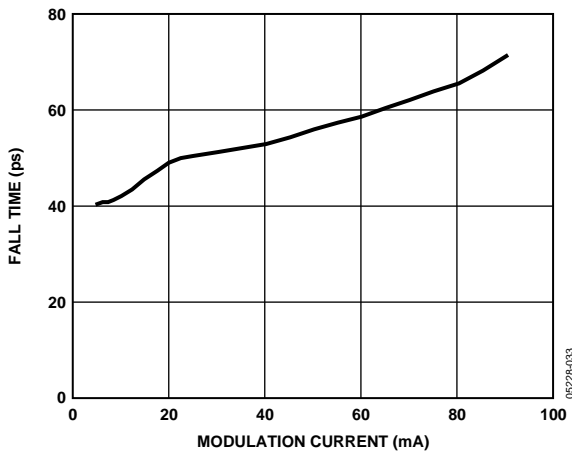

Figure 17. Fall Time vs. Modulation Current, $I_{BIAS} = 20$ mA

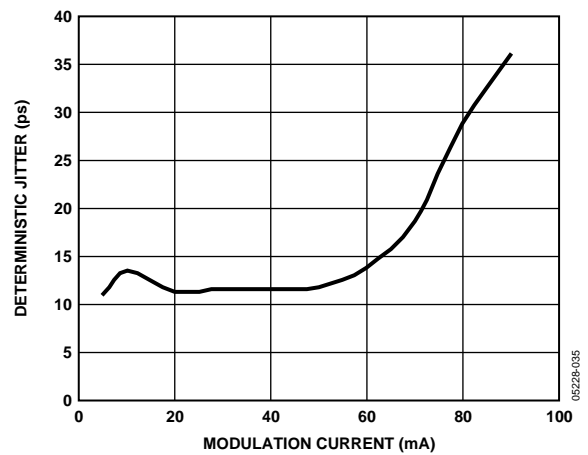

Figure 19. Deterministic Jitter at 4.25 Gbps vs. Modulation Current, $I_{BIAS} = 20$ mA

PERFORMANCE CHARACTERISTICS

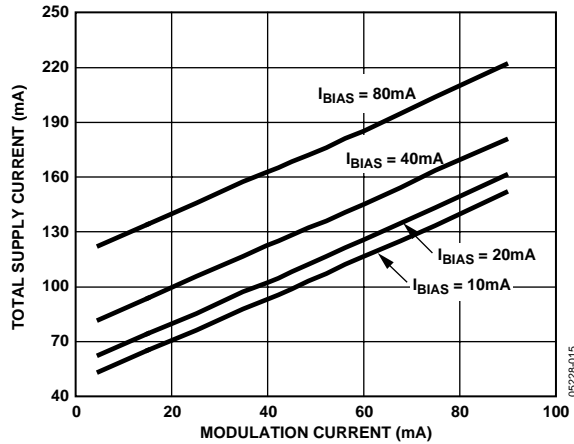

Figure 20. Total Supply Current vs. Modulation Current
 Total Supply Current = $I_{CC} + I_{BIAS} + I_{MOD}$

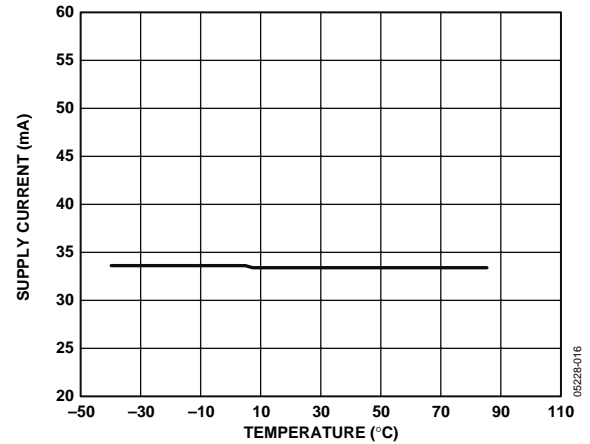

Figure 23. Supply Current (I_{CC}) vs. Temperature with ALS Asserted,
 $I_{BIAS} = 20\text{ mA}$

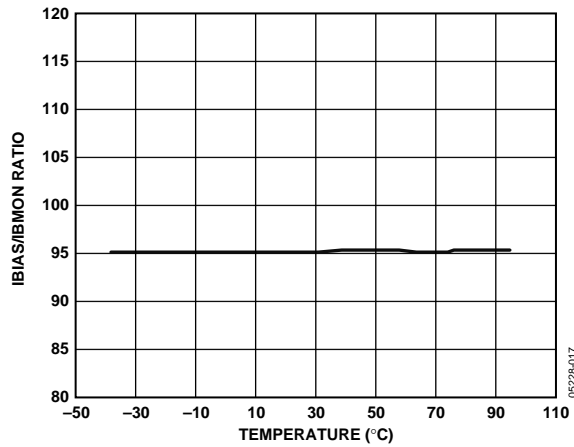

Figure 21. IBIAS/IBMON Gain vs. Temperature, $I_{BIAS} = 20\text{ mA}$

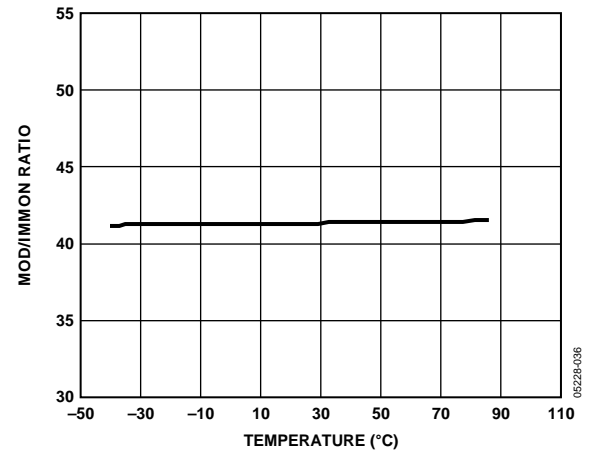

Figure 24. IMOD/IMMON Gain vs. Temperature, $I_{MOD} = 30\text{ mA}$

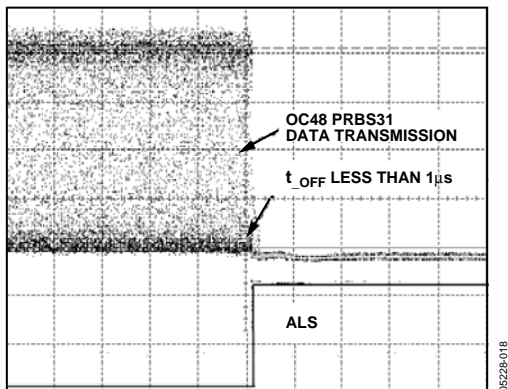

Figure 22. ALS Assert Time, 5 µs/div

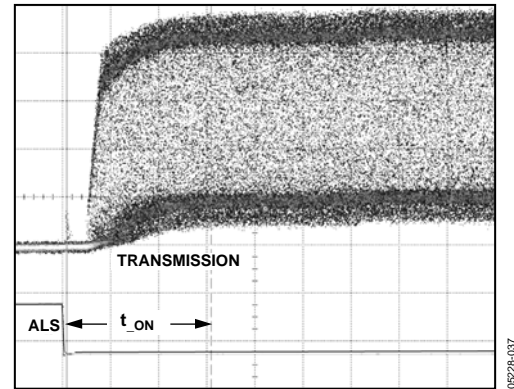

Figure 25. ALS Negate Time, 50 µs/div

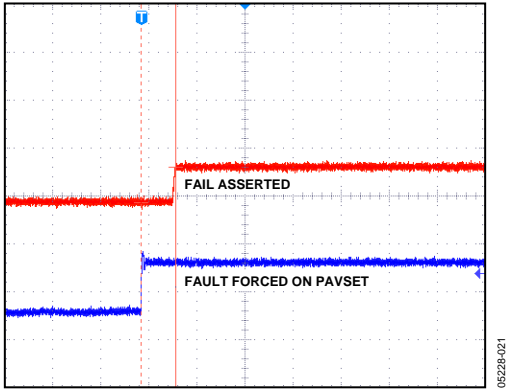

Figure 26. FAIL Assert Time, 1 μ s/div

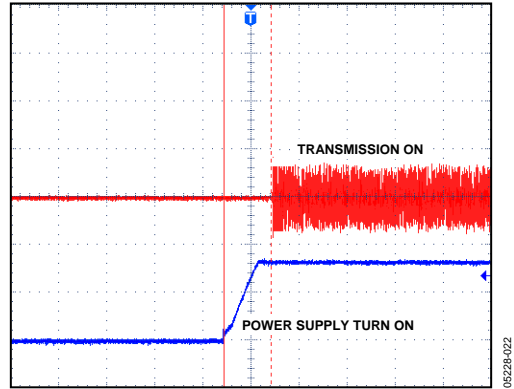

Figure 27. Time to Initialize, Including Reset, 40 ms/div

THEORY OF OPERATION

Laser diodes have a current-in to light-out transfer function, as shown in Figure 28. Two key characteristics of this transfer function are the threshold current, I_{th} , and the slope in the linear region beyond the threshold current, referred to as the slope efficiency, LI .

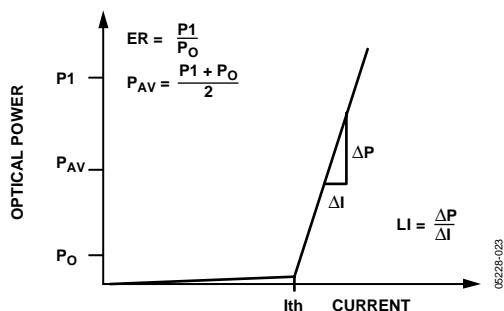

Figure 28. Laser Transfer Function

LASER CONTROL

Typically laser threshold current and slope efficiency are both functions of temperature. For FP- and DFB-type lasers, the threshold current increases and the slope efficiency decreases with increasing temperature. In addition, these parameters vary as the laser ages. To maintain a constant optical average power and a constant optical extinction ratio over temperature and laser lifetime, it is necessary to vary the applied electrical bias current and modulation current to compensate for the changing LI characteristics of the laser.

Average Power Control Loop (APCL)

The APCL compensates for changes in I_{th} and LI by varying I_{BIAS} . Average power control is performed by measuring MPD current, I_{MPD} . This current is bandwidth-limited by the MPD. This is not a problem because the APCL is required to respond to the average current from the MPD.

Extinction Ratio (ER) Control

ER control is implemented by adjusting the modulation current. Temperature calibration is required in order to adjust the modulation current to compensate for variations of the laser characteristics with temperature.

CONTROL METHODS

The ADN2871 has two methods for setting the average power (P_{AV}) and extinction ratio (ER). The average power and extinction ratio can be voltage-set using the output of a microcontroller's voltage DACs to provide controlled reference voltages, P_{AVREF} and $ERREF$. Alternatively, the average power and extinction ratio can be resistor-set using potentiometers at the P_{AVSET} and $ERSET$ pins, respectively.

VOLTAGE SETPOINT CALIBRATION

The ADN2871 allows interface to a microcontroller for both control and monitoring (see Figure 29). The average power and extinction ratio can be set using the microcontroller DACs to provide controlled reference voltages P_{AVREF} and $ERREF$.

$$P_{AVREF} = P_{AV} \times R_{SP} \times R_{PAV} \text{ (Volts)}$$

$$ERREF = \frac{I_{MOD} \times R_{ERSET}}{100} \text{ (Volts)}$$

where:

- R_{SP} = is the optical responsivity (in amperes per watt).
- P_{AV} is the average power required.
- $R_{PAV} = R_{ERSET} = 1 \text{ k}\Omega$.
- I_{MOD} = Modulation current

In voltage setpoint mode, R_{PAV} and R_{ERSET} must be $1 \text{ k}\Omega$ resistors with a 1% tolerance and a temperature coefficient of $50 \text{ ppm}/^\circ\text{C}$.

Power-On Sequence in Voltage Setpoint Mode

Note that during power up, there is an internal sequence that allows 25 ms before enabling the alarms; therefore, the customer must ensure that the voltage for P_{AVREF} and $ERREF$ are active within 20 ms after ramp-up of the power supply. If the P_{AVREF} and $ERREF$ voltages are supplied after 25 ms then the part alarms and FAIL is activated.

RESISTOR SETPOINT CALIBRATION

In resistor setpoint calibration, PAVREF, ERREF, and RPAV must all be tied to V_{CC}. The average power and extinction ratio can be set using the PAVSET and ERSET pins, respectively. A resistor is placed between the pin and GND to set the current flowing in each pin as shown in Figure 30. The ADN2871 ensures that both PAVSET and ERSET are kept 1.23 V above GND. The PAVSET and ERSET resistors are given by

$$R_{PAVSET} = \frac{1.2 \text{ V}}{P_{AV} \times R_{SP}} (\Omega)$$

$$R_{ERSET} = \frac{1.2 \text{ V} \times 100}{I_{MOD}} (\Omega)$$

where:

- R_{SP} = is the optical responsivity (in amperes per watt).
- I_{MOD} is the modulation current required.
- P_{AV} is the average power required.

IMPD MONITORING

IMPD monitoring can be implemented for voltage setpoint and resistor setpoint as described next.

Voltage Setpoint

In voltage setpoint calibration, two methods may be used for IMPD monitoring.

Method 1: Measuring Voltage at RPAV

The IMPD current is equal to the voltage at RPAV divided by the value of RPAV (see Figure 31) as long as the laser is on and is being controlled by the control loop. This method does not provide a valid IMPD reading when the laser is in shutdown or fail mode. A microconverter buffered ADC input may be connected to RPAV to make this measurement. No decoupling or filter capacitors should be placed on the RPAV node because this can disturb the control loop.

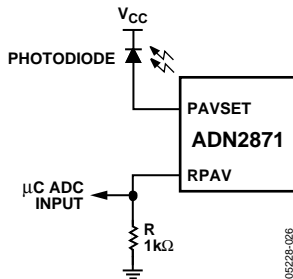

Figure 31. Single Measurement of IMPD RPAV in Voltage Setpoint Mode

Method 2: Measuring IMPD Across a Sense Resistor

The second method has the advantage of providing a valid IMPD reading at all times, but has the disadvantage of requiring a differential measurement across a sense resistor directly in series with the IMPD. As shown in Figure 32, a small resistor, R_x, is placed in series with the IMPD. If the laser used in the design has a pinout where the monitor photodiode cathode and the lasers anode are not connected, a sense resistor can be placed in series with the photodiode cathode and V_{CC}, as shown in Figure 33. When choosing the value of the resistor, the user must take into account the expected IMPD value in normal operation. The resistor must be large enough to make a significant signal for the buffered ADC to read, but small enough not to cause a significant voltage reduction across the IMPD. The voltage across the sense resistor should not exceed 250 mV when the laser is in normal operation. It is recommended that a 10 pF capacitor be placed in parallel with the sense resistor.

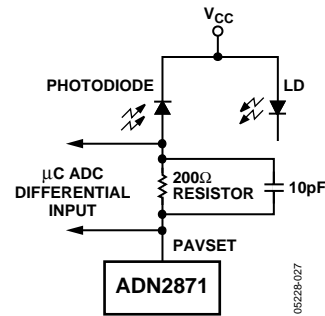

Figure 32. Differential Measurement of IMPD Across a Sense Resistor

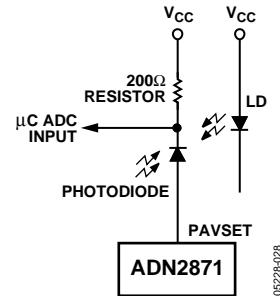

Figure 33. Single Measurement of IMPD Across a Sense Resistor

Resistor Setpoint

In resistor setpoint calibration, the current through the resistor from PAVSET to ground is the IMPD current. The recommended method for measuring the IMPD current is to place a small resistor in series with the PAVSET resistor (or potentiometer) and measure the voltage across this resistor as shown in Figure 34. The IMPD current is then equal to this voltage divided by the value of resistor used. In resistor setpoint calibration, PAVSET is held to 1.2 V nominal; it is recommended that the sense resistor should be selected so that the voltage across the sense resistor does not exceed 250 mV.

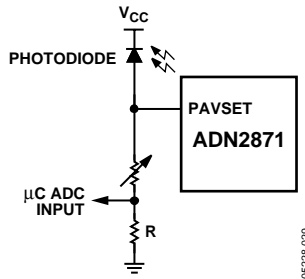

Figure 34. Single Measurement of IMPD Across a Sense Resistor in Resistor Setpoint IMPD Monitoring

LOOP BANDWIDTH SELECTION

To ensure that the ADN2871 control loop has sufficient bandwidth, the average power loop capacitor (PAVCAP) is calculated using the laser's slope efficiency (watts/amperes) and the average power required.

For resistor setpoint control:

$$PAVCAP = 3.2E - 6 \times \frac{LI}{PAV} \text{ (Farad)}$$

For voltage setpoint control:

$$PAVCAP = 1.28E - 6 \times \frac{LI}{PAV} \text{ (Farad)}$$

where PAV is the average power required and LI (mW/mA) is the typical slope efficiency at 25°C of a batch of lasers that are used in a design.

LI can be calculated as

$$LI = \frac{PI - P0}{I_{MOD}} \text{ (mW/mA)}$$

where PI is the optical power (mW) at the one level, and $P0$ is the optical power (mW) at the zero level.

The capacitor value equation is used to get a centered value for the particular type of laser that is used in a design and an average power setting. The laser LI can vary by a factor of 7 between different physical lasers of the same type and across temperatures without the need to recalculate the PAVCAP value.

This capacitor is placed between the PAVCAP pin and ground. It is important that the capacitor is a low leakage, multilayer ceramic type with an insulation resistance greater than 100 GΩ or a time constant of 1000 seconds, whichever is less. Pick a standard off-the-shelf capacitor value such that the actual capacitance is within ±30% of the calculated value after the capacitor's own tolerance is taken into account.

POWER CONSUMPTION

The ADN2871 die temperature must be kept below 125°C. The LFCSP has an exposed paddle, which should be connected so that it is at the same potential as the ADN2871 ground pins. Power consumption can be calculated as

$$I_{CC} = I_{CC \text{ min}} + 0.3 I_{MOD}$$

$$P = V_{CC} \times I_{CC} + (I_{BIAS} \times V_{BIAS_PIN}) + I_{MOD} (V_{MODP_PIN} + V_{MODN_PIN})/2$$

$$T_{DIE} = T_{AMBIENT} + \theta_{JA} \times P$$

Thus, the maximum combination of $I_{BIAS} + I_{MOD}$ must be calculated

where:

$I_{CC \text{ min}} = 30$ mA, the typical value of I_{CC} provided in Table 1 with $I_{BIAS} = I_{MOD} = 0$.

T_{DIE} is the die temperature.

$T_{AMBIENT}$ is the ambient temperature.

V_{BIAS_PIN} is the voltage at the IBIAS pin.

V_{MODP_PIN} is the voltage at the IMODP pin.

V_{MODN_PIN} is the voltage at the IMODN pin.

AUTOMATIC LASER SHUTDOWN (TX_DISABLE)

ALS (TX_DISABLE) is an input that is used to shut down the transmitter's optical output. The ALS pin is pulled up internally with a 6 kΩ resistor, and conforms to SFP MSA specifications. When ALS is logic high or when open, both the bias and modulation currents are turned off. If an alarm has triggered and the bias and modulation currents are turned off, ALS can be brought high and then low to clear the alarm.

BIAS AND MODULATION MONITOR CURRENTS

IBMON and IMMON are current-controlled current sources that mirror a ratio of the bias and modulation current. The monitor bias current, IBMON, and the monitor modulation current, IMMON, both should be connected to ground through a resistor to provide a voltage proportional to the bias current and modulation current, respectively. When using a microcontroller, the voltage developed across these resistors can be connected to two of the ADC channels, making available a digital representation of the bias and modulation current.

DATA INPUTS

Data inputs should be ac-coupled (10 nF capacitors are recommended) and are terminated via a 100 Ω internal resistor between the DATAP and DATAN pins. A high impedance circuit sets the common-mode voltage and is designed to allow maximum input voltage headroom over temperature. It is necessary to use ac-coupling to eliminate the need for matching between common-mode voltages.

LASER DIODE INTERFACING

Figure 35 shows the recommended circuit for interfacing the ADN2871 to most TO-Can or coax lasers. DFB and FP lasers typically have impedances of 5 Ω to 7 Ω, and have axial leads. The circuit shown works over the full range of data rates from 155 Mbps to 3.3Gbps, including multirate operation (with no change to PAVCAP and ERCAP values); see the Multirate Performance Using Low Cost Fabry Perot Tosa NEC NX7315UA section for multirate performance examples. Coax lasers have special characteristics that make them difficult to interface to. They tend to have higher inductance, and their impedance is not well controlled. The circuit in Figure 35 operates by deliberately mismaturing the transmission line on the laser side, while providing a very high quality matching network on the driver side. The impedance of the driver side matching network is very flat in comparison to frequency and enables multirate operation. A series damping resistor should not be used.

The 30 Ω transmission line used is a compromise between drive current required and the total power consumed. Other transmission line values can be used, with some modification of the component values. In Figure 35, the R and C snubber values 24 Ω and 2.2 pF, respectively, represent a starting point and must be tuned for the particular model of laser being used. R_p, the pull-up resistor, is in series with a very small (0.5 nH) inductor. In some cases, an inductor is not required or can be accommodated with deliberate parasitic inductance, such as a thin trace or a via, placed on the PC board.

Care should be taken to mount the laser as close as possible to the PC board, minimizing the exposed lead length between the laser can and the edge of the board. The axial lead of a coax laser is very inductive (approximately 1 nH per mm). Long exposed leads result in slower edge rates and reduced eye margin.

Recommended component layouts and gerber files are available by contacting the factory. Note that the circuit in Figure 35 can supply up to 56 mA of modulation current to the laser, sufficient for most lasers available today. Higher currents can be accommodated by changing transmission lines and backmatch values; contact the factory for recommendations. This interface circuit is not recommended for butterfly-style lasers or other lasers with 25 Ω characteristic impedance. Instead, a 25 Ω transmission line and inductive (instead of resistive) pull-up is recommended. The ADN2871 single-ended application shown in Figure 35 is recommended for use up to 2.7 Gbps. From 2.7 Gbps to 4.25 Gbps, a differential drive is recommended when driving VCSELs or lasers that have slow fall times. Differential drive can be implemented by adding a few extra components. A possible implementation is shown in Figure 36. The bias and modulation currents that are programmed into the ADN2871 need to be larger than the bias and modulation current required at the laser, due to the laser ac coupling interface and because some modulation current flows in pull-up resistors R1 and R2.

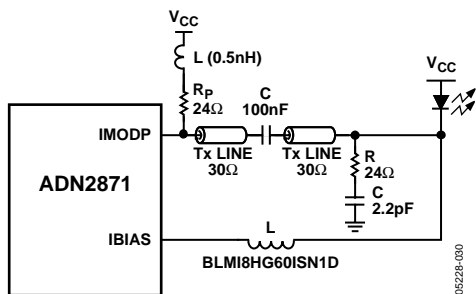
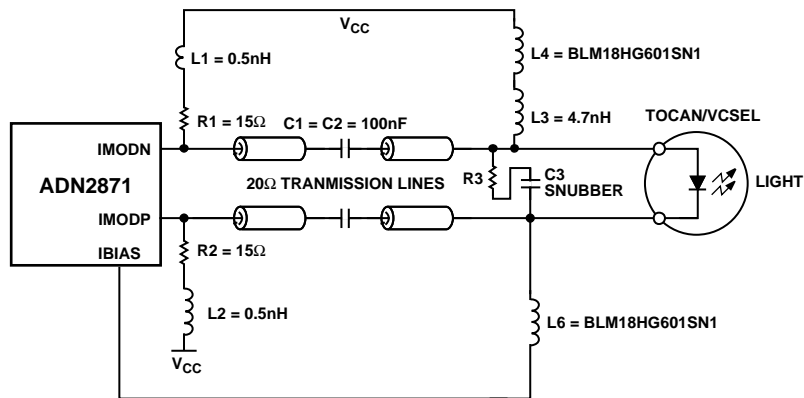

Figure 35. Recommended Interface for ADN2871 AC Coupling



SNUBBER SETTINGS: 40Ω AND 1.5pF, NOT OPTIMIZED, OPTIMIZATION SHOULD CONSIDER PARASITIC.

Figure 36. Recommended Differential Drive Circuit

ADN2871

ALARMS

The ADN2871 has a latched, active high monitoring alarm (FAIL). The FAIL alarm output is an open drain in conformance to SFP MSA specification requirements.

The ADN2871 has a three-fold alarm system that covers

- Use of a bias current higher than expected, probably as a result of laser aging.
- Out-of-bounds average voltage at the monitor photodiode (MPD) input, indicating an excessive amount of laser power or a broken loop.
- Undervoltage in the IBIAS node (laser diode cathode) that would increase the laser power.

The bias current alarm trip point is set by selecting the value of resistor on the IBMON pin to GND. The alarm is triggered when the voltage on the IBMON pin goes above 1.2 V. FAIL is activated when the single-point faults in Table 6 occur. The

circuit in Figure 37 can be used to indicate that FAIL has been activated while allowing the bias and modulation currents to remain on. The transistor's V_{BE} clamps the FAIL voltage to below 1.3 V disabling the automatic shutdown of bias and modulation currents. If an alarm has triggered and FAIL is activated ALS can be brought high and then low to clear the alarm.

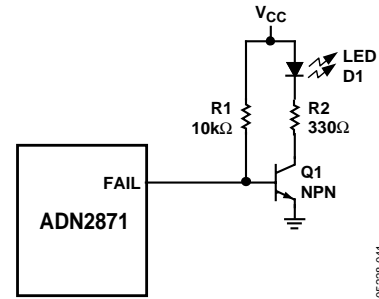

Figure 37. FAIL Indication Circuit

Table 6. ADN2871 Single-Point Alarms

Alarm Type	Pin Name	Over Voltage or Short to VCC Condition	Under Voltage or Short to GND Condition
Bias Current	IBMON	Alarm if >1.2 V typical (+/-10% tolerance)	Ignore
MPD Current	PAVSET	Alarm if >threshold (typical threshold 1.5 V to 2.1 V)	Alarm if < threshold (typical threshold (0.6 V to 1.1 V)
Crucial Nodes	ERREF	Alarm if shorted to VCC	Ignore
	IBIAS	Ignore	Alarm if shorted to GND

Table 7. ADN2871 Response to Various Single-Point Faults in AC-Coupled Configuration (as shown in Figure 35)

Pin	Short to VCC	Short to GND	Open
CCBIAS	Fault state occurs	Fault state occurs	Does not increase laser average power
PAVSET	Fault state occurs	Fault state occurs	Fault state occurs
PAVREF	Voltage mode: Fault state occurs Resistor mode: Tied to VCC	Fault state occurs	Fault state occurs
RPAV	Voltage mode: Fault state occurs Resistor mode: Tied to VCC	Fault state occurs	Voltage mode: Fault state occurs Resistor mode: Does not increase average power
PAVCAP	Fault state occurs	Fault state occurs	Fault state occurs
DATAP	Does not increase laser average power	Does not increase laser average power	Does not increase laser average power
DATAN	Does not increase laser average power	Does not increase laser average power	Does not increase laser average power
ALS	Output currents shut off	Normal currents	Output currents shut off
ERSET	Does not increase laser average power	Does not increase laser average power	Does not increase laser average power
IMMON	Does not affect laser power	Does not increase laser average power	Does not increase laser average power
ERREF	Voltage mode: Fault state occurs Resistor mode: Tied to VCC	Voltage mode: Does not increase average power Resistor mode: Fault state occurs	Does not increase laser average power
IBMON	Fault state occurs	Does not increase laser average power	Does not increase laser average power
FAIL	Fault state occurs	Does not increase laser average power	Does not increase laser average power
IMODP	Does not increase laser average power	Does not increase laser average power	Does not increase laser average power
IMODN	Does not increase laser average power	Does not increase laser average power	Does not increase laser power
IBIAS	Fault state occurs	Fault state occurs	Fault state occurs

OUTLINE DIMENSIONS

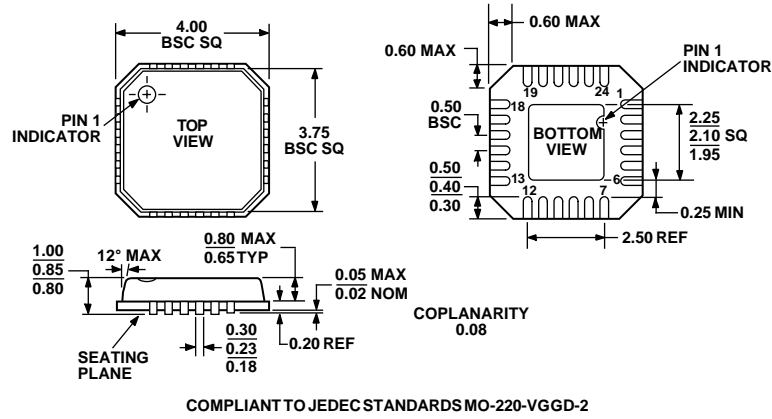

Figure 38. 24-Lead Lead Frame Chip Scale Package [LFCSP_VQ]
 4 mm × 4 mm Body, Very Thin Quad
 (CP-24-3)
 Dimensions shown in millimeters

Note: The LFCSP has an exposed paddle that must be connected to ground.

ORDERING GUIDE

Model	Temperature Range	Package Description	Package Option
ADN2871ACPZ ¹	-40°C to +85°C	24-Lead Lead Frame Chip Scale Package (LFCSP_VQ)	CP-24-3
ADN2871ACPZ-RL ¹	-40°C to +85°C	24-Lead Lead Frame Chip Scale Package (LFCSP_VQ)	CP-24-3
ADN2871ACPZ-RL7 ¹	-40°C to +85°C	24-Lead Lead Frame Chip Scale Package (LFCSP_VQ)	CP-24-3

¹ Z = Pb-free part.

ADN2871

NOTES