

1M x 32Bit x 4 Banks Mobile SDRAM in 90FBGA

FEATURES

- 1.8V power supply.
- LVCMOS compatible with multiplexed address.
- Four banks operation.
- MRS cycle with address key programs.
 - CAS latency (1, 2 & 3).
 - Burst length (1, 2, 4, 8 & Full page).
 - Burst type (Sequential & Interleave).
- EMRS cycle with address key programs.
- All inputs are sampled at the positive going edge of the system clock.
- Burst read single-bit write operation.
- Special Function Support.
 - PASR (Partial Array Self Refresh).
 - Internal TCSR (Temperature Compensated Self Refresh)
 - DS (Driver Strength)
 - DPD (Deep Power Down)
- DQM for masking.
- Auto refresh.
- 64ms refresh period (4K cycle).
- Commercial Temperature Operation (-25°C ~ 70°C).
- Extended Temperature Operation (-25°C ~ 85°C).
- 90Balls FBGA (-FXXX -Pb, -HXXX -Pb Free).

GENERAL DESCRIPTION

The K4M28323PH is 134,217,728 bits synchronous high data rate Dynamic RAM organized as 4 x 1,048,576 words by 32 bits, fabricated with SAMSUNG's high performance CMOS technology. Synchronous design allows precise cycle control with the use of system clock and I/O transactions are possible on every clock cycle. Range of operating frequencies, programmable burst lengths and programmable latencies allow the same device to be useful for a variety of high bandwidth and high performance memory system applications.

ORDERING INFORMATION

Part No.	Max Freq.	Interface	Package
K4M28323PH-F(H)E/G/C/F75	133MHz(CL3), 83MHz(CL2)	LVCMOS	90 FBGA Pb (Pb Free)
K4M28323PH-F(H)E/G/C/F90	111MHz(CL3), 83MHz(CL2)		
K4M28323PH-F(H)E/G/C/F1L	111MHz(CL3) ^{*1} , 66MHz(CL2)		

- F(H)E/G : Normal / Low Power, Extended Temperature(-25°C ~ 85°C)
 - F(H)C/F : Normal / Low Power, Commercial Temperature(-25°C ~ 70°C)

Notes :

1. In case of 40MHz Frequency, CL1 can be supported.

Address configuration

Organization	Bank	Row	Column Address
4M x 32	BA0, BA1	A0 - A11	A0 - A7

INFORMATION IN THIS DOCUMENT IS PROVIDED IN RELATION TO SAMSUNG PRODUCTS, AND IS SUBJECT TO CHANGE WITHOUT NOTICE. NOTHING IN THIS DOCUMENT SHALL BE CONSTRUED AS GRANTING ANY LICENSE, EXPRESS OR IMPLIED, BY ESTOPPEL OR OTHERWISE, TO ANY INTELLECTUAL PROPERTY RIGHTS IN SAMSUNG PRODUCTS OR TECHNOLOGY. ALL INFORMATION IN THIS DOCUMENT IS PROVIDED ON AS "AS IS" BASIS WITHOUT GUARANTEE OR WARRANTY OF ANY KIND.

1. For updates or additional information about Samsung products, contact your nearest Samsung office.

2. Samsung products are not intended for use in life support, critical care, medical, safety equipment, or similar applications where Product failure could result in loss of life or personal or physical harm, or any military or defense application, or any governmental procurement to which special terms or provisions may apply.

FUNCTIONAL BLOCK DIAGRAM

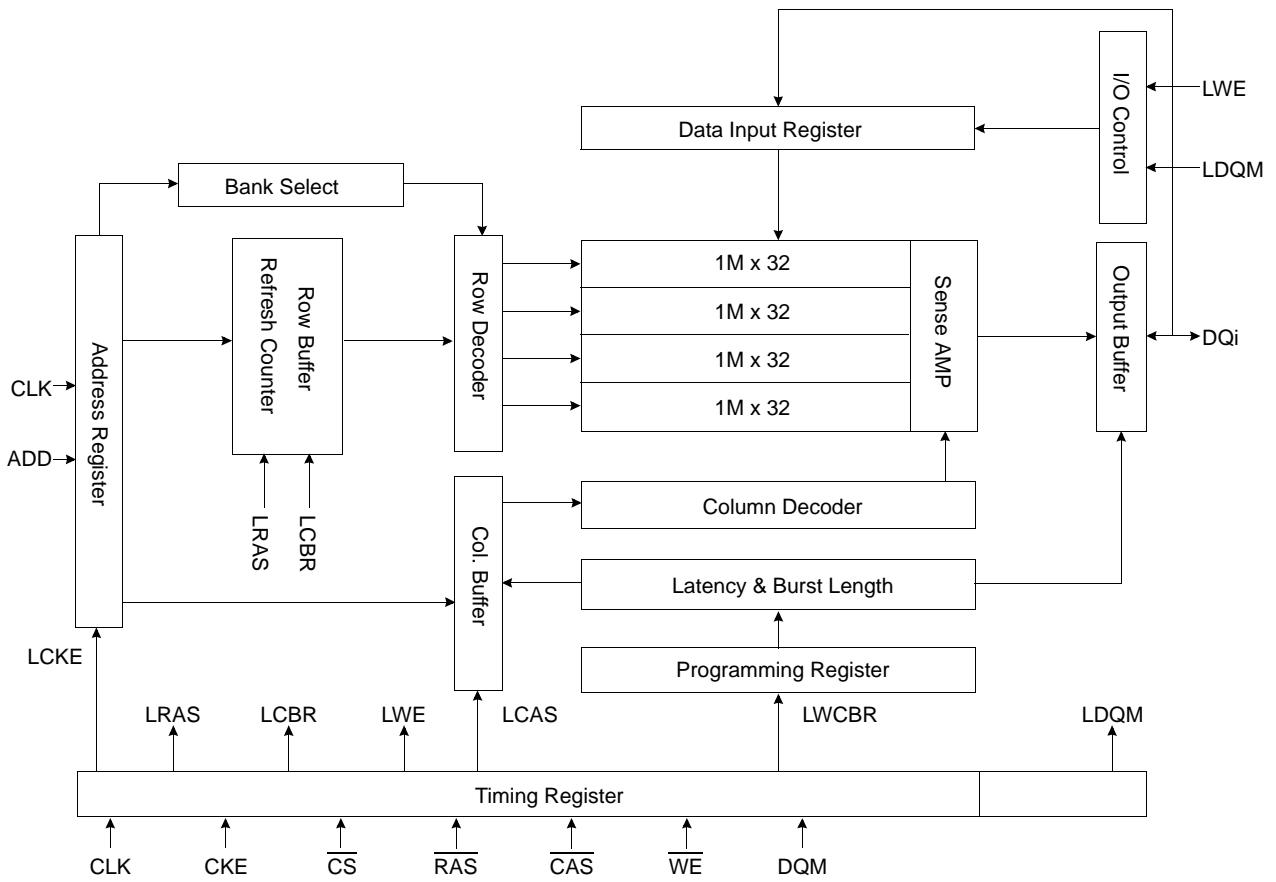

Package Dimension and Pin Configuration

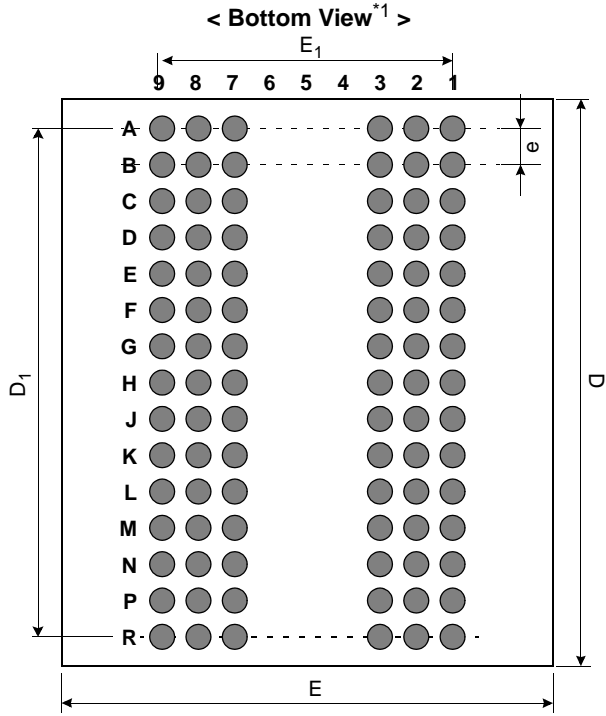

< Top View^{*2} >

90Ball(6x15) FBGA						
	1	2	3	7	8	9
A	DQ26	DQ24	Vss	VDD	DQ23	DQ21
B	DQ28	VDDQ	VSSQ	VDDQ	VSSQ	DQ19
C	VSSQ	DQ27	DQ25	DQ22	DQ20	VDDQ
D	VSSQ	DQ29	DQ30	DQ17	DQ18	VDDQ
E	VDDQ	DQ31	NC	NC	DQ16	VSSQ
F	Vss	DQM3	A3	A2	DQM2	VDD
G	A4	A5	A6	A10	A0	A1
H	A7	A8	NC	NC	BA1	A11
J	CLK	CKE	A9	BA0	\overline{CS}	RAS
K	DQM1	NC	NC	\overline{CAS}	\overline{WE}	DQM0
L	VDDQ	DQ8	Vss	VDD	DQ7	VSSQ
M	VSSQ	DQ10	DQ9	DQ6	DQ5	VDDQ
N	VSSQ	DQ12	DQ14	DQ1	DQ3	VDDQ
P	DQ11	VDDQ	VSSQ	VDDQ	VSSQ	DQ4
R	DQ13	DQ15	Vss	VDD	DQ0	DQ2

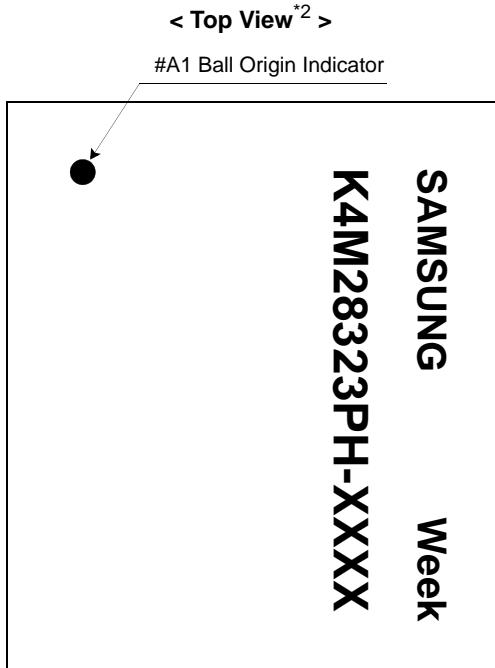
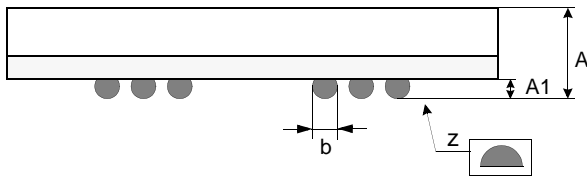

Pin Name	Pin Function
CLK	System Clock
\overline{CS}	Chip Select
CKE	Clock Enable
A0 ~ A11	Address
BA0 ~ BA1	Bank Select Address
RAS	Row Address Strobe
\overline{CAS}	Column Address Strobe
\overline{WE}	Write Enable
DQM0 ~ DQM3	Data Input/Output Mask
DQ0 ~ 31	Data Input/Output
VDD/VSS	Power Supply/Ground
VDDQ/VSSQ	Data Output Power/Ground

[Unit:mm]

Symbol	Min	Typ	Max
A	-	-	1.00
A ₁	0.25	-	-
E	7.90	8.00	8.10
E ₁	-	6.40	-
D	12.90	13.00	13.10
D ₁	-	11.20	-
e	-	0.80	-
b	0.45	0.50	0.55
z	-	-	0.10

ABSOLUTE MAXIMUM RATINGS

Parameter	Symbol	Value	Unit
Voltage on any pin relative to V _{ss}	V _{IN} , V _{OUT}	-1.0 ~ 2.6	V
Voltage on V _{DD} supply relative to V _{ss}	V _{DD} , V _{DDQ}	-1.0 ~ 2.6	V
Storage temperature	T _{STG}	-55 ~ +150	°C
Power dissipation	P _D	1.0	W
Short circuit current	I _{OS}	50	mA

NOTES:

Permanent device damage may occur if ABSOLUTE MAXIMUM RATINGS are exceeded.
 Functional operation should be restricted to recommended operating condition.
 Exposure to higher than recommended voltage for extended periods of time could affect device reliability.

DC OPERATING CONDITIONS

Recommended operating conditions (Voltage referenced to V_{ss} = 0V, T_A = -25°C ~ 85°C for Extended, -25°C ~ 70°C for Commercial)

Parameter	Symbol	Min	Typ	Max	Unit	Note
Supply voltage	V _{DD}	1.7	1.8	1.95	V	1
	V _{DDQ}	1.7	1.8	1.95	V	1
Input logic high voltage	V _{IH}	0.8 x V _{DDQ}	1.8	V _{DDQ} + 0.3	V	2
Input logic low voltage	V _{IL}	-0.3	0	0.3	V	3
Output logic high voltage	V _{OH}	V _{DDQ} - 0.2	-	-	V	I _{OH} = -0.1mA
Output logic low voltage	V _{OL}	-	-	0.2	V	I _{OL} = 0.1mA
Input leakage current	I _{LI}	-2	-	2	uA	4

NOTES :

- Under all conditions, V_{DDQ} must be less than or equal to V_{DD}.
- V_{IH} (max) = 2.2V AC. The overshoot voltage duration is ≤ 3ns.
- V_{IL} (min) = -1.0V AC. The undershoot voltage duration is ≤ 3ns.
- Any input 0V ≤ V_{IN} ≤ V_{DDQ}.
 Input leakage currents include Hi-Z output leakage for all bi-directional buffers with tri-state outputs.
- Dout is disabled, 0V ≤ V_{OUT} ≤ V_{DDQ}.

CAPACITANCE (V_{DD} = 1.8V, T_A = 23°C, f = 1MHz, V_{REF} = 0.9V ± 50 mV)

Pin	Symbol	Min	Max	Unit	Note
Clock	C _{CLK}	1.5	3.5	pF	
RAS, CAS, WE, CS, CKE, DQM	C _{IN}	1.5	3.0	pF	
Address	C _{ADD}	1.5	3.0	pF	
DQ0 ~ DQ31	C _{OUT}	2.0	4.5	pF	

DC CHARACTERISTICS

Recommended operating conditions (Voltage referenced to V_{SS} = 0V, T_A = -25°C ~ 85°C for Extended, -25°C ~ 70°C for Commercial)

Parameter	Symbol	Test Condition	Version			Unit	Note	
			-75	-90	-1L			
Operating Current (One Bank Active)	I _{CC1}	Burst length = 1 t _{RC} ≥ t _{RC(min)} I _O = 0 mA	45	40	40	mA	1	
Precharge Standby Current in power-down mode	I _{CC2P}	CKE ≤ V _{IL(max)} , t _{CC} = 10ns	0.3			mA		
	I _{CC2PS}	CKE & CLK ≤ V _{IL(max)} , t _{CC} = ∞	0.3					
Precharge Standby Current in non power-down mode	I _{CC2N}	CKE ≥ V _{IH(min)} , \overline{CS} ≥ V _{IH(min)} , t _{CC} = 10ns Input signals are changed one time during 20ns	10			mA		
	I _{CC2NS}	CKE ≥ V _{IH(min)} , CLK ≤ V _{IL(max)} , t _{CC} = ∞ Input signals are stable	1					
Active Standby Current in power-down mode	I _{CC3P}	CKE ≤ V _{IL(max)} , t _{CC} = 10ns	5			mA		
	I _{CC3PS}	CKE & CLK ≤ V _{IL(max)} , t _{CC} = ∞	2					
Active Standby Current in non power-down mode (One Bank Active)	I _{CC3N}	CKE ≥ V _{IH(min)} , \overline{CS} ≥ V _{IH(min)} , t _{CC} = 10ns Input signals are changed one time during 20ns	20			mA		
	I _{CC3NS}	CKE ≥ V _{IH(min)} , CLK ≤ V _{IL(max)} , t _{CC} = ∞ Input signals are stable	10					
Operating Current (Burst Mode)	I _{CC4}	I _O = 0 mA Page burst 4Banks Activated t _{CCD} = 2CLKs	60	50	50	mA	1	
Refresh Current	I _{CC5}	t _{ARFC} ≥ t _{ARFC(min)}	100	95	95	mA	2	
Self Refresh Current	I _{CC6}	CKE ≤ 0.2V	Internal TCSR		45 ^{*4}	85/70	°C	3
			-E/C	Full Array	150	250		
				1/2 of Full	140	210		
				1/4 of Full	135	190		
			-G/F	Full Array	100	200	6	
				1/2 of Full	90	160		
1/4 of Full	85	140						
Deep Power Down Current	I _{CC8}	CKE ≤ 0.2V	10			uA	7	

NOTES:

1. Measured with outputs open.
2. Refresh period is 64ms.
3. Internal TCSR can be supported.
In commercial Temp : 45°C/Max 70°C. In extended Temp : 45°C/Max 85°C.
4. It has +/-5 °C tolerance.
5. K4M28323PH-S(D)E/C**
6. K4M28323PH-S(D)G/F**
7. DPD(Deep Power Down) function is an optional feature and it will be enabled upon request.
Please contact Samsung for more information.
7. Unless otherwise noted, input swing level is CMOS(V_{IH} /V_{IL}=V_{DDQ}/V_{SSQ}).

AC OPERATING TEST CONDITIONS ($V_{DD} = 1.7V \sim 1.95V$, $T_A = -25 \sim 85^\circ C$ for Extended, $-25 \sim 70^\circ C$ for Commercial)

Parameter	Value	Unit
AC input levels (V_{ih}/V_{il})	$0.9 \times V_{DDQ} / 0.2$	V
Input timing measurement reference level	$0.5 \times V_{DDQ}$	V
Input rise and fall time	$t_r/t_f = 1/1$	ns
Output timing measurement reference level	$0.5 \times V_{DDQ}$	V
Output load condition	See Figure 2	

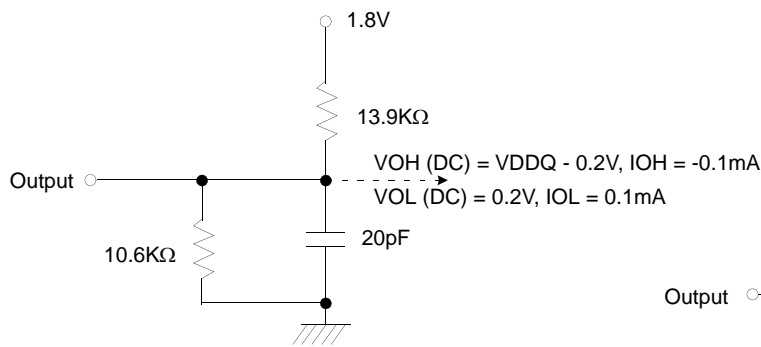

Figure 1. DC Output Load Circuit

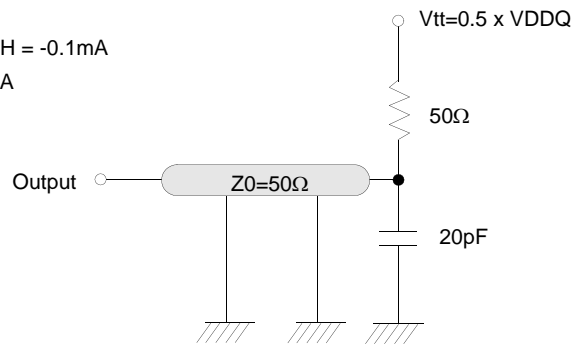

Figure 2. AC Output Load Circuit

OPERATING AC PARAMETER

(AC operating conditions unless otherwise noted)

Parameter	Symbol	Version			Unit	Note
		-75	-90	-1L		
Row active to row active delay	tRRD(min)	15	18	18	ns	1
RAS to CAS delay	trCD(min)	22.5	24	27	ns	1
Row precharge time	tRP(min)	22.5	24	27	ns	1
Row active time	tRAS(min)	50	50	50	ns	1
	tRAS(max)	100			us	
Row cycle time	tRC(min)	72.5	74	77	ns	1
Last data in to row precharge	tRDL(min)	15			ns	2
Last data in to Active delay	tDAL(min)	tRDL + tRP			-	
Last data in to new col. address delay	tCDL(min)	1			CLK	2
Last data in to burst stop	tBDL(min)	1			CLK	2
Auto refresh cycle time	tARFC(min)	80			ns	3
Exit self refresh to active command	tSRFX(min)	120			ns	
Col. address to col. address delay	tCCD(min)	1			CLK	4
Number of valid output data	CAS latency=3	2			ea	5
Number of valid output data	CAS latency=2	1				
Number of valid output data	CAS latency=1	-	0			

NOTES:

1. The minimum number of clock cycles is determined by dividing the minimum time required with clock cycle time and then rounding off to the next higher integer.
2. Minimum delay is required to complete write.
3. Maximum burst refresh cycle : 8
4. All parts allow every cycle column address change.
5. In case of row precharge interrupt, auto precharge and read burst stop.

AC CHARACTERISTICS(AC operating conditions unless otherwise noted)

Parameter		Symbol	-75		-90		-1L		Unit	Note
			Min	Max	Min	Max	Min	Max		
CLK cycle time	CAS latency=3	tCC	7.5	1000	9	1000	9	1000	ns	1
	CAS latency=2	tCC	12		12		15			
	CAS latency=1	tCC	-		-		25			
CLK to valid output delay	CAS latency=3	tSAC		6		7		7	ns	1,2
	CAS latency=2	tSAC		9		9		10		
	CAS latency=1	tSAC		-		-		20		
Output data hold time	CAS latency=3	tOH	2.5		2.5		2.5		ns	2
	CAS latency=2	tOH	2.5		2.5		2.5			
	CAS latency=1	tOH	-		-		2.5			
CLK high pulse width		tCH	2.5		3.0		3.0		ns	3
CLK low pulse width		tCL	2.5		3.0		3.0		ns	3
Input setup time		tSS	2.0		2.0		2.0		ns	3
Input hold time		tSH	1		1		1		ns	3
CLK to output in Low-Z		tSLZ	1		1		1		ns	2
CLK to output in Hi-Z	CAS latency=3	tSHZ		6		7		7	ns	
	CAS latency=2			9		9		10		
	CAS latency=1			-		-		20		

NOTES :

- Parameters depend on programmed CAS latency.
- If clock rising time is longer than 1ns, (tr/2-0.5)ns should be added to the parameter.
- Assumed input rise and fall time (tr & tf) = 1ns.
If tr & tf is longer than 1ns, transient time compensation should be considered, i.e., [(tr + tf)/2-1]ns should be added to the parameter.

SIMPLIFIED TRUTH TABLE

COMMAND		CKEn-1	CKEn	\overline{CS}	\overline{RAS}	\overline{CAS}	\overline{WE}	DQM	BA0,1	A10/AP	A11, A9 ~ A0	Note
Register	Mode Register Set	H	X	L	L	L	L	X	OP CODE			1, 2
Refresh	Auto Refresh	H	H	L	L	L	H	X	X			3
	Self Refresh		Entry								L	
		Exit	L	H	L	H	H	H	X	X		3
	H				X	X	X	3				
Bank Active & Row Addr.		H	X	L	L	H	H	X	V	Row Address		
Read & Column Address	Auto Precharge Disable	H	X	L	H	L	H	X	V	L	Column Address (A0~A7)	4
	Auto Precharge Enable									H		4, 5
Write & Column Address	Auto Precharge Disable	H	X	L	H	L	L	X	V	L	Column Address (A0~A7)	4
	Auto Precharge Enable									H		4, 5
Deep Power Down	Entry	H	L	L	H	H	L	X	X			
	Exit	L	H	H	X	X	X	X				
Burst Stop		H	X	L	H	H	L	X	X			6
Precharge	Bank Selection	H	X	L	L	H	L	X	V	L	X	
	All Banks								X	H		
Clock Suspend or Active Power Down	Entry	H	L	H	X	X	X	X	X			
	Exit			L	H	X	X				X	X
Precharge Power Down Mode	Entry	H	L	H	X	X	X	X	X			
				L	H	H	H					
	Exit	L	H	H	X	X	X	X				
				L	V	V	V					
DQM		H	X				V	X			7	
No Operation Command		H	X	H	X	X	X	X	X			
				L	H	H	H					

(V=Valid, X=Don't Care, H=Logic High, L=Logic Low)

NOTES :

- OP Code : Operand Code
A0 ~ A11 & BA0 ~ BA1 : Program keys. (@MRS)
- MRS can be issued only at all banks precharge state.
A new command can be issued after 2 CLK cycles of MRS.
- Auto refresh functions are the same as CBR refresh of DRAM.
The automatical precharge without row precharge command is meant by "Auto".
Auto/self refresh can be issued only at all banks precharge state.
Partial self refresh can be issued only after setting partial self refresh mode of EMRS.
- BA0 ~ BA1 : Bank select addresses.
- During burst read or write with auto precharge, new read/write command can not be issued.
Another bank read/write command can be issued after the end of burst.
New row active of the associated bank can be issued at tRP after the end of burst.
- Burst stop command is valid at every burst length.
- DQM sampled at the positive going edge of CLK masks the data-in at that same CLK in write operation (Write DQM latency is 0), but in read operation, it makes the data-out Hi-Z state after 2 CLK cycles. (Read DQM latency is 2).

A. MODE REGISTER FIELD TABLE TO PROGRAM MODES

Register Programmed with Normal MRS

Address	BA0 ~ BA1	A11 ~ A10/AP	A9*2	A8	A7	A6	A5	A4	A3	A2	A1	A0
Function	"0" Setting for Normal MRS	RFU	W.B.L	Test Mode		CAS Latency			BT	Burst Length		

Normal MRS Mode

Test Mode			CAS Latency				Burst Type			Burst Length				
A8	A7	Type	A6	A5	A4	Latency	A3	Type		A2	A1	A0	BT=0	BT=1
0	0	Mode Register Set	0	0	0	Reserved	0	Sequential		0	0	0	1	1
0	1	Reserved	0	0	1	1	1	Interleave		0	0	1	2	2
1	0	Reserved	0	1	0	2	Mode Select			0	1	0	4	4
1	1	Reserved	0	1	1	3	BA1	BA0	Mode	0	1	1	8	8
Write Burst Length			1	0	0	Reserved	0	0	Setting for Normal MRS	1	0	0	Reserved	Reserved
A9	Length		1	0	1	Reserved				1	0	1	Reserved	Reserved
0	Burst		1	1	0	Reserved				1	1	0	Reserved	Reserved
1	Single Bit		1	1	1	Reserved				1	1	1	Full Page	Reserved

Register Programmed with Extended MRS

Address	BA1	BA0	A11 ~ A10/AP	A9	A8	A7	A6	A5	A4	A3	A2	A1	A0
Function	Mode Select		RFU*1				DS		RFU*1		PASR		

EMRS for PASR(Partial Array Self Ref.) & DS(Driver Strength)

Mode Select			Driver Strength				PASR				
BA1	BA0	Mode	A6	A5	Driver Strength		A2	A1	A0	Size of Refreshed Array	
0	0	Normal MRS	0	0	Full		0	0	0	Full Array	
0	1	Reserved	0	1	1/2		0	0	1	1/2 of Full Array	
1	0	EMRS for Mobile SDRAM	1	0	1/4		0	1	0	1/4 of Full Array	
1	1	Reserved	1	1	1/8		0	1	1	Reserved	
Reserved Address							1	0	0	Reserved	
A11~A10/AP		A9	A8	A7	A4	A3	1	0	1	Reserved	
0		0	0	0	0	0	1	1	0	Reserved	
							1	1	1	Reserved	

NOTES:

1. RFU(Reserved for future use) should stay "0" during MRS cycle.
2. If A9 is high during MRS cycle, "Burst Read Single Bit Write" function will be enabled.

Partial Array Self Refresh

1. In order to save power consumption, Mobile SDRAM has PASR option.
2. Mobile SDRAM supports 3 kinds of PASR in self refresh mode : full array, 1/2 of full array, 1/4 of full array.

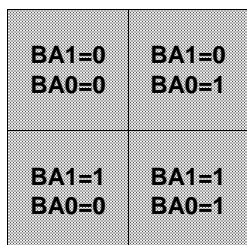

- Full Array

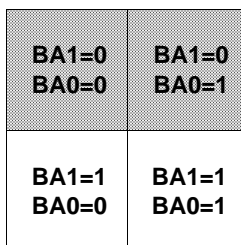

- 1/2 Array

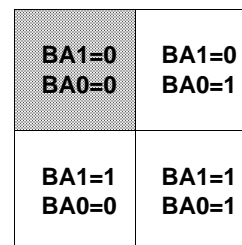

- 1/4 Array

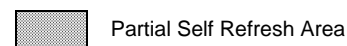

Internal Temperature Compensated Self Refresh (TCSR)

Note :

1. In order to save power consumption, Mobile-SDRAM includes the internal temperature sensor and control units to control the self refresh cycle automatically according to the two temperature range ; 45 °C and 85 °C(for Extended) / 70 °C(for Commercial).
2. If the EMRS for external TCSR is issued by the controller, this EMRS code for TCSR is ignored.
3. It has +/- 5 °C tolerance.

Temperature Range	Self Refresh Current (IDD6)						Unit
	- E / C			- G / F			
	Full Array	1/2 Array	1/4 Array	Full Array	1/2 Array	1/4 Array	
45 °C*3	150	140	135	100	90	85	uA
85/70 °C	250	210	190	200	160	140	

B. POWER UP SEQUENCE

1. Apply power and attempt to maintain CKE at a high state and all other inputs may be undefined.
 - Apply VDD before or at the same time as VDDQ.
2. Maintain stable power, stable clock and NOP input condition for a minimum of 200us.
3. Issue precharge commands for all banks of the devices.
4. Issue 2 or more auto-refresh commands.
5. Issue a mode register set command to initialize the mode register.
6. Issue a extended mode register set command to define DS or PASR operating type of the device after normal MRS.

For operating with DS or PASR , set DS or PASR mode in EMRS setting stage.
 In order to adjust another mode in the state of DS or PASR mode, additional EMRS set is required but power up sequence is not needed again at this time. In that case, all banks have to be in idle state prior to adjusting EMRS set.

C. BURST SEQUENCE

1. BURST LENGTH = 4

Initial Address		Sequential				Interleave			
A1	A0								
0	0	0	1	2	3	0	1	2	3
0	1	1	2	3	0	1	0	3	2
1	0	2	3	0	1	2	3	0	1
1	1	3	0	1	2	3	2	1	0

2. BURST LENGTH = 8

Initial Address			Sequential								Interleave								
A2	A1	A0																	
0	0	0	0	1	2	3	4	5	6	7	0	1	2	3	4	5	6	7	
0	0	1	1	2	3	4	5	6	7	0	1	0	3	2	5	4	7	6	
0	1	0	2	3	4	5	6	7	0	1	2	3	0	1	6	7	4	5	
0	1	1	3	4	5	6	7	0	1	2	3	2	1	0	7	6	5	4	
1	0	0	4	5	6	7	0	1	2	3	4	5	6	7	0	1	2	3	
1	0	1	5	6	7	0	1	2	3	4	5	4	7	6	1	0	3	2	
1	1	0	6	7	0	1	2	3	4	5	6	7	4	5	2	3	0	1	
1	1	1	7	0	1	2	3	4	5	6	7	6	5	4	3	2	1	0	