

TECHNICAL DATA
DATA SHEET 4590, REV. -

HERMETIC SCHOTTKY RECTIFIER

Very Low Forward Voltage Drop

Features:

- Soft Reverse Recovery at Low and High Temperature
- Very Low Forward Voltage Drop
- Low Power Loss, High Efficiency
- High Surge Capacity
- Guard Ring for Enhanced Durability and Long Term Reliability
- Guaranteed Reverse Avalanche Characteristics

Maximum Ratings

Characteristics	Symbol	Condition	Max.	Units
Peak Inverse Voltage	V_{RWM}	-	100	V
Max. Average Forward Current	$I_{F(AV)}$	50% duty cycle, rectangular wave form (Single)	15	A
Max. Average Forward Current	$I_{F(AV)}$	50% duty cycle, rectangular wave form (Common Cathode)	30	A
Max. Peak One Cycle Non-Repetitive Surge Current	I_{FSM}	8.3 ms, half Sine wave (per leg)	280	A
Non-Repetitive Avalanche Energy	E_{AS}	$T_J = 25\text{ }^\circ\text{C}$, $I_{AS} = 3.0\text{ A}$, $L = 4.4\text{ mH}$ (per leg)	20	mJ
Repetitive Avalanche Current	I_{AR}	I_{AS} decay linearly to 0 in 1 μs f limited by T_J max $V_A=1.5V_R$	3.0	A
Maximum Thermal Resistance	$R_{\theta JC}$	DC operation	0.40	$^\circ\text{C/W}$
Max. Junction Temperature	T_J	-	-65 to +200	$^\circ\text{C}$
Max. Storage Temperature	T_{stg}	-	-65 to +200	$^\circ\text{C}$

Electrical Characteristics

Characteristics	Symbol	Condition	Max.	Units
Max. Forward Voltage Drop (per leg)	V_{F1}	@ 15A, Pulse, $T_J = 25\text{ }^\circ\text{C}$	0.84	V
	V_{F2}	@ 15A, Pulse, $T_J = 125\text{ }^\circ\text{C}$	0.68	V
Max. Reverse Current (per leg)	I_{R1}	@ $V_R = 100\text{V}$, Pulse, $T_J = 25\text{ }^\circ\text{C}$	0.01	mA
	I_{R2}	@ $V_R = 100\text{V}$, Pulse, $T_J = 125\text{ }^\circ\text{C}$	1	mA
Max. Junction Capacitance (per leg)	C_T	@ $V_R = 5\text{V}$, $T_C = 25\text{ }^\circ\text{C}$ $f_{SIG} = 1\text{MHz}$, $V_{SIG} = 50\text{mV}$ (p-p)	500	pF

TECHNICAL DATA
DATA SHEET 4590, REV. -

MECHANICAL DIMENSIONS: In Inches / mm

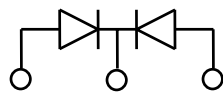
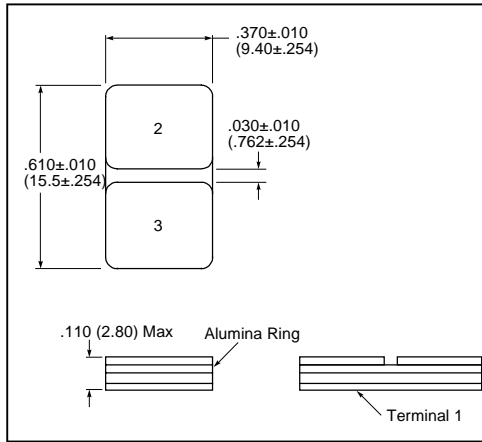

1 2 3
PINOUT TABLE

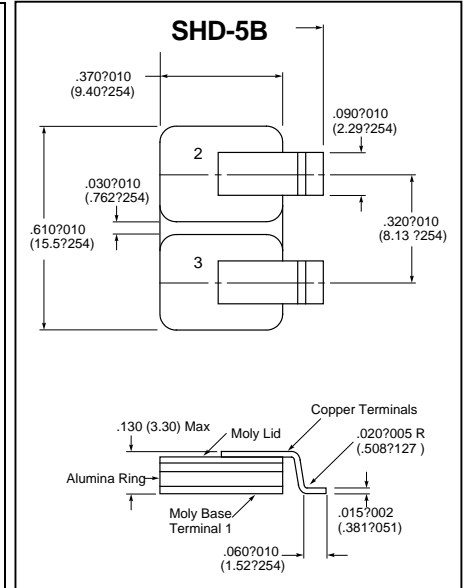
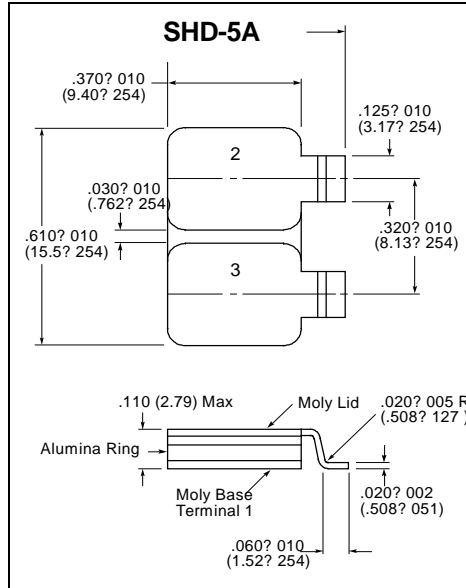

DEVICE TYPE	PIN 1	PIN 2	PIN 3
DUAL RECTIFIER, COMMON CATHODE (P)	COMMON CATHODE	ANODE	ANODE

Note: The V_f curves shown are for the SD125SCU100 unpackaged die only.

Typical Forward Characteristics

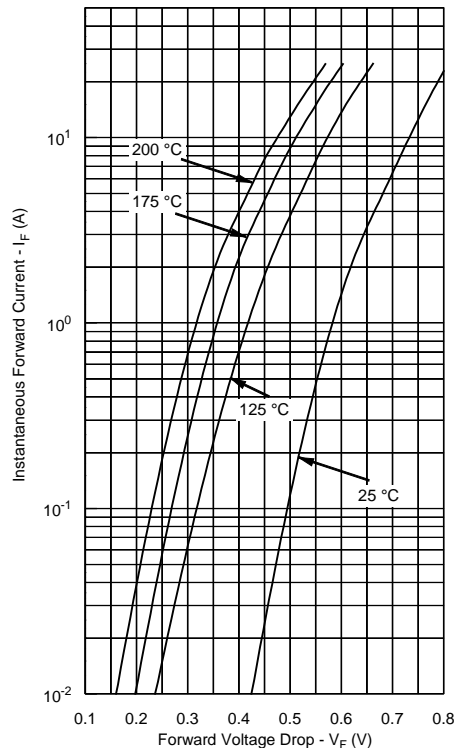

Typical Reverse Characteristics

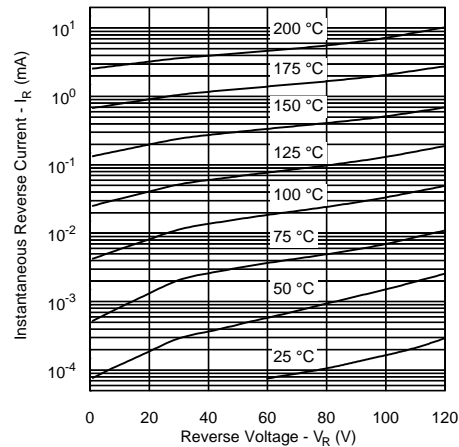

Typical Junction Capacitance

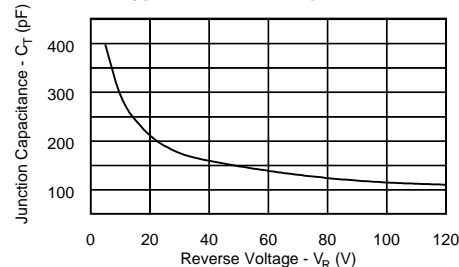

TECHNICAL DATA

DISCLAIMER:

- 1- The information given herein, including the specifications and dimensions, is subject to change without prior notice to improve product characteristics. Before ordering, purchasers are advised to contact the Sensitron Semiconductor sales department for the latest version of the datasheet(s).
- 2- In cases where extremely high reliability is required (such as use in nuclear power control, aerospace and aviation, traffic equipment, medical equipment, and safety equipment), safety should be ensured by using semiconductor devices that feature assured safety or by means of users' fail-safe precautions or other arrangement.
- 3- In no event shall Sensitron Semiconductor be liable for any damages that may result from an accident or any other cause during operation of the user's units according to the datasheet(s). Sensitron Semiconductor assumes no responsibility for any intellectual property claims or any other problems that may result from applications of information, products or circuits described in the datasheets.
- 4- In no event shall Sensitron Semiconductor be liable for any failure in a semiconductor device or any secondary damage resulting from use at a value exceeding the absolute maximum rating.
- 5- No license is granted by the datasheet(s) under any patents or other rights of any third party or Sensitron Semiconductor.
- 6- The datasheet(s) may not be reproduced or duplicated, in any form, in whole or part, without the expressed written permission of Sensitron Semiconductor.
- 7- The products (technologies) described in the datasheet(s) are not to be provided to any party whose purpose in their application will hinder maintenance of international peace and safety nor are they to be applied to that purpose by their direct purchasers or any third party. When exporting these products (technologies), the necessary procedures are to be taken in accordance with related laws and regulations.