

Silicon NPN Power Transistor

T-33-11

Applications: Switching mode power supply

Features:

- In triple diffusion technique
- Glass passivation
- High reverse voltage
- Short switching time
- Power dissipation 62 W

Dimensions in mm

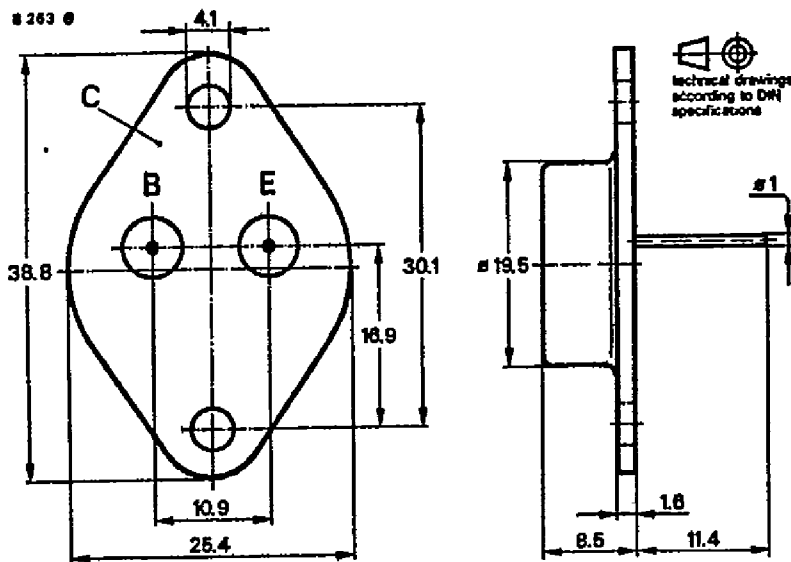

Collector connected with case

Standard metal case
3 B 2 DIN 41 872
JEDEC TO 3
Weight max. 20 g

Accessories

Isolating washer No. 569524

Absolute maximum ratings

Collector emitter voltage

V_{CEO} 480 V

V_{CES} 1100 V

V_{CER} 1100 V

$R_{BE} \approx 100 \Omega$

Collector peak current

I_{CM} 10 A

Collector current

I_C 8 A

Base current

I_{BM} 4 A

$-I_{BM}$ 4 A

Total power dissipation

P_{tot} 62 W

$T_{case} \leq 25^\circ C$

Junction temperature

T_j 150 $^\circ C$

Storage temperature range

T_{stg} -65 ... +150 $^\circ C$

Maximum thermal resistance

Junction case

R_{thJC} 2 K/W

Characteristics	Min.	Typ.	Max.
$T_{case} = 25^\circ C$, unless otherwise specified			
Collector cut-off current			
$V_{CE} = 1100 V$			1 mA
$T_j = 125^\circ C, V_{CE} = 1100 V$			2 mA
Collector-emitter breakdown voltage			
$I_C = 100 mA, L_C = 125 mH$	$V_{(BR)CEO}^{1)}$	480	V
Emitter-base breakdown voltage			
$I_C = 4 A, I_B = 1 A$	$V_{(BR)EBO}$	6	V
Base saturation voltage			
$I_C = 4 A, I_B = 0.8 A$	$V_{BEsat}^{1)}$		2 V
DC forward current transfer ratio			
$V_{CE} = 5 V, I_C = 1 A$	h_{FE}	10	
$V_{CE} = 5 V, I_C = 4 A$	h_{FE}	5.5	
Gain bandwidth product			
$V_{CE} = 10 V, I_C = 500 mA, f = 1 MHz$	f_T	10	MHz
Switching characteristics $I_C = 4 A, I_{B1} = -I_{B2} = 1.25 A, t_p = 20 \mu s$			
Fall time	$t_f^{2)}$		1 μs
Turn-off time	t_{off}		4 μs

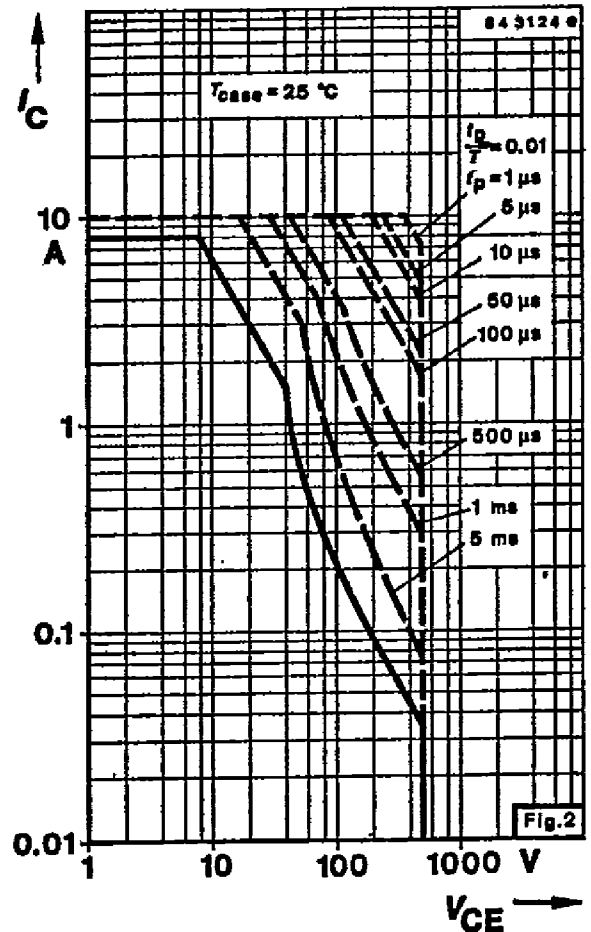
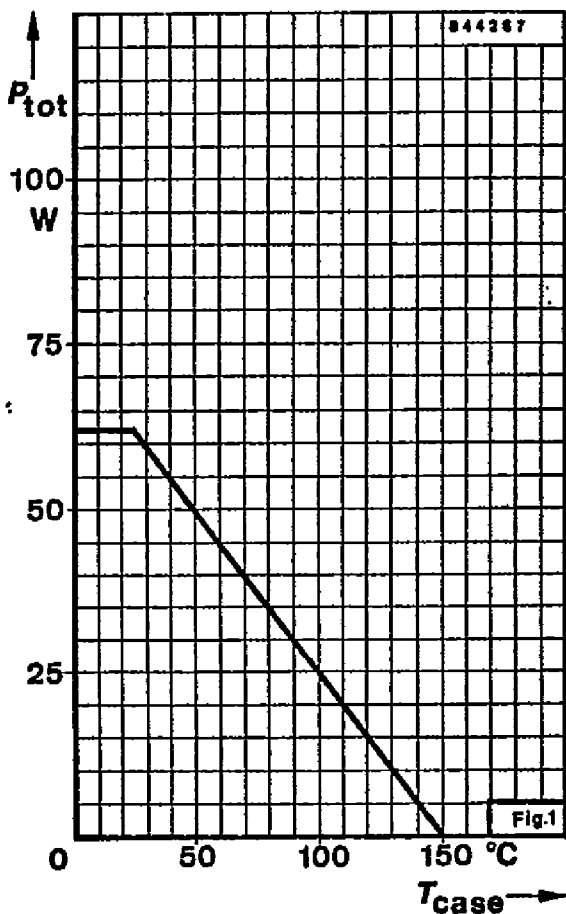

¹⁾ $\frac{t_p}{T} \geq 0.01, t_p = 0.1 ms$; ²⁾ By using retrace capacitor at switching-off inductive load

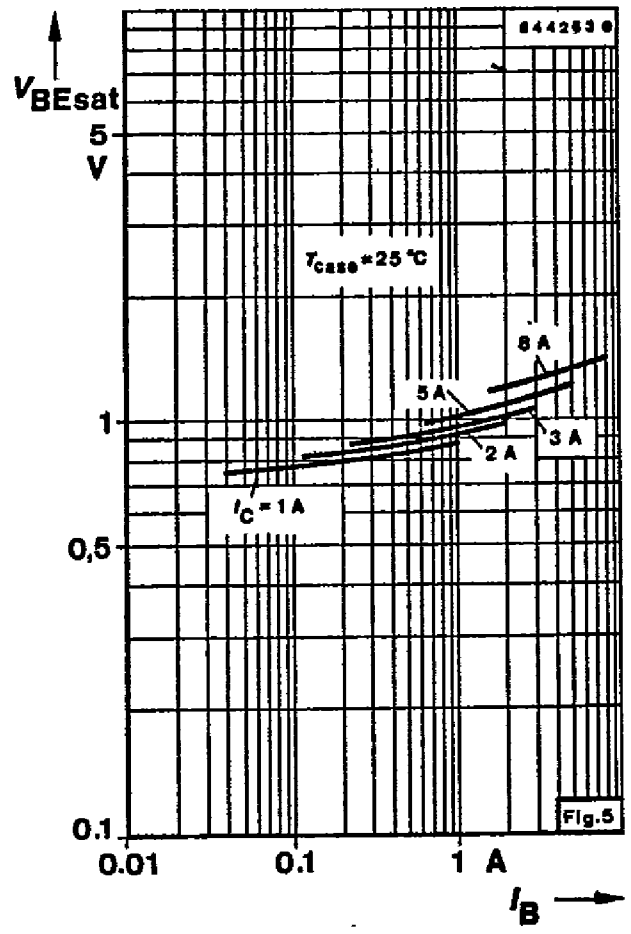
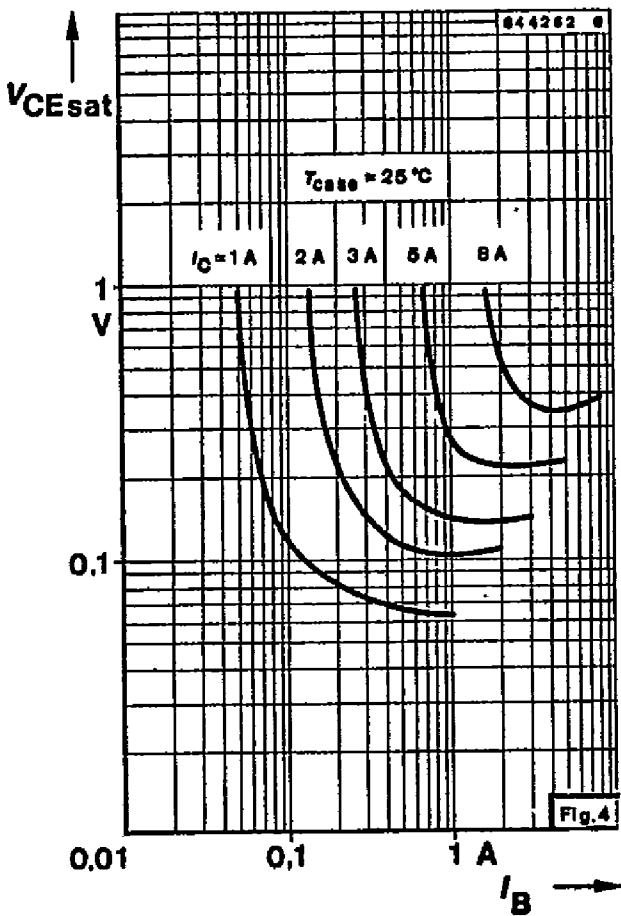
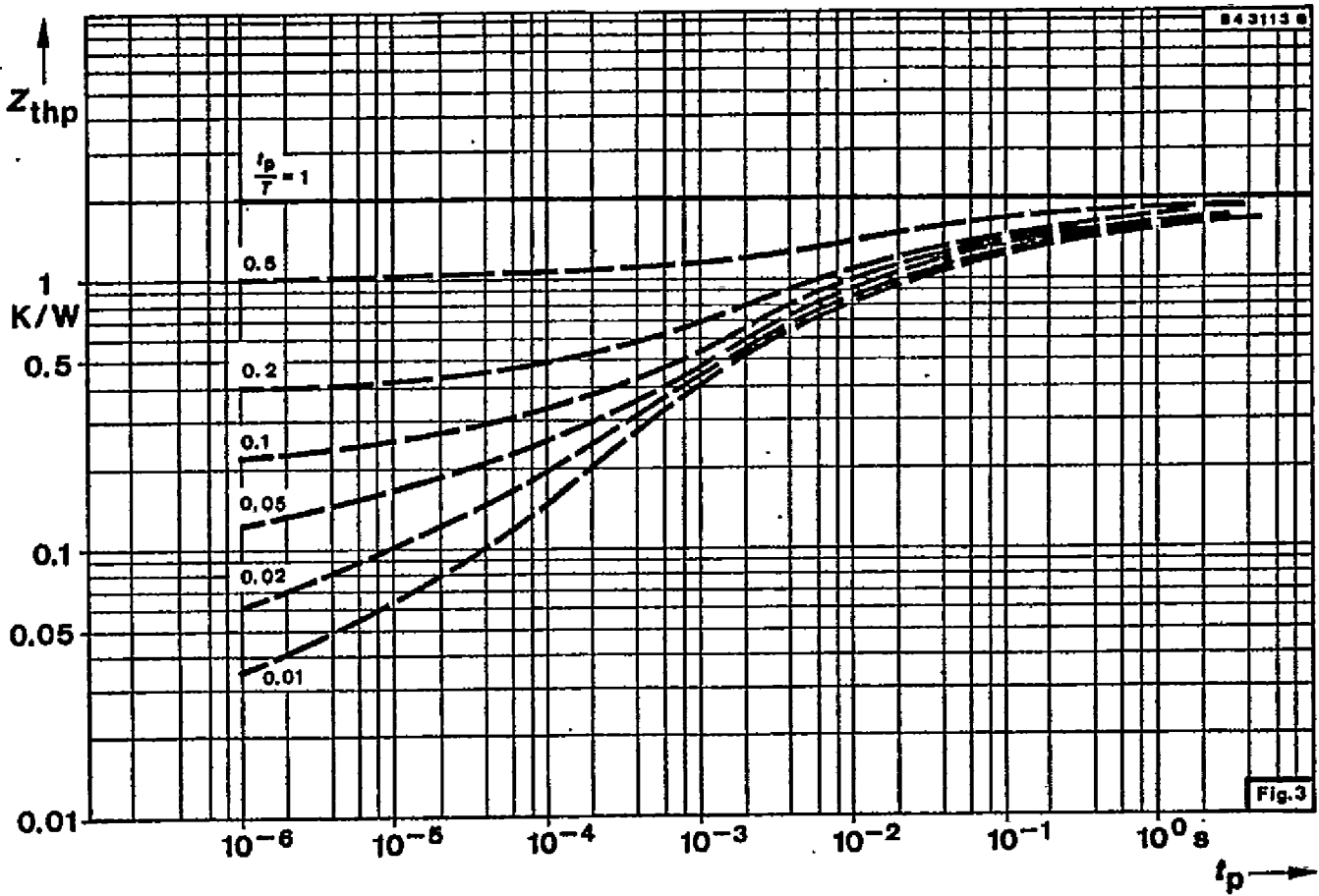

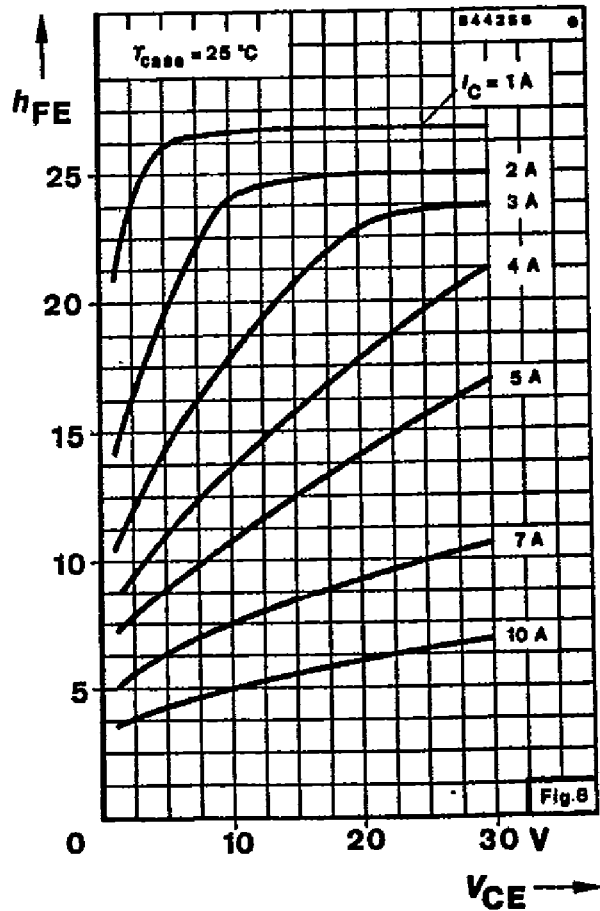
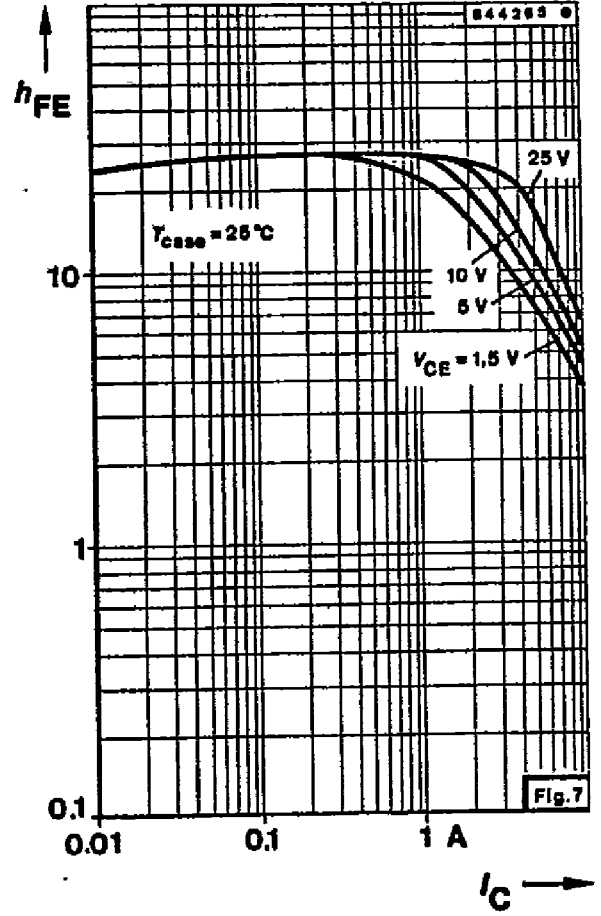
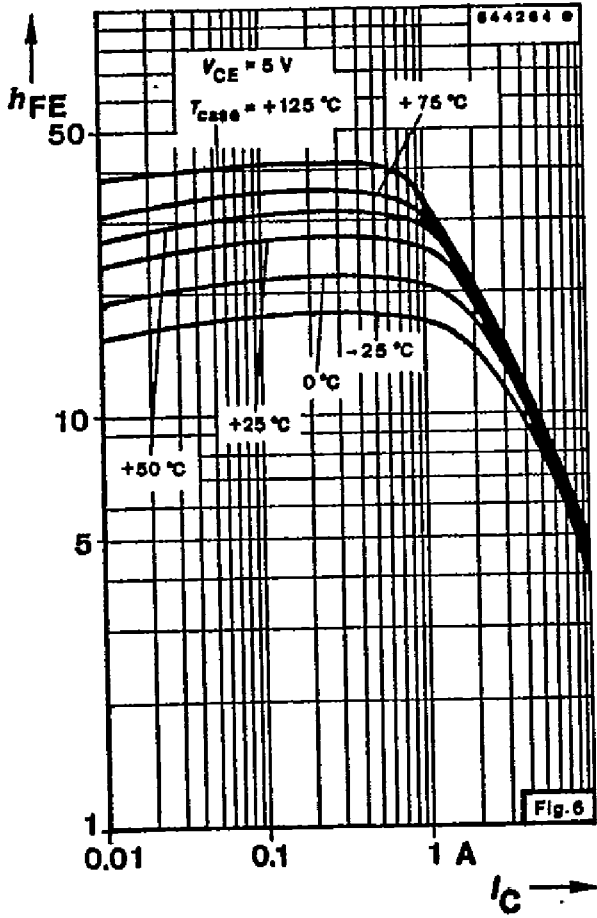

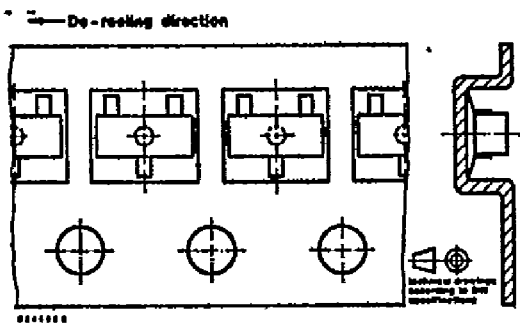

Fig. 7.4 Standard taped SOT 23

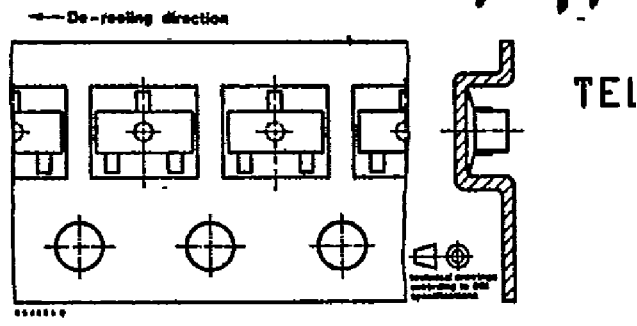

Fig. 7.6 Reverse taped SOT 23

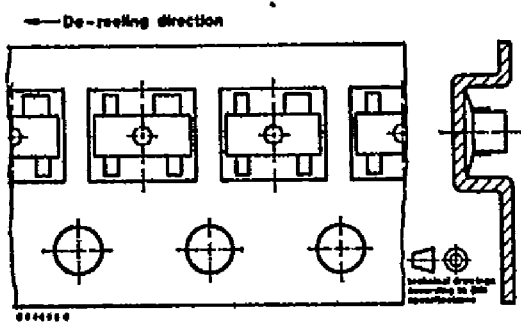

Fig. 7.5 Standard taped SOT 143

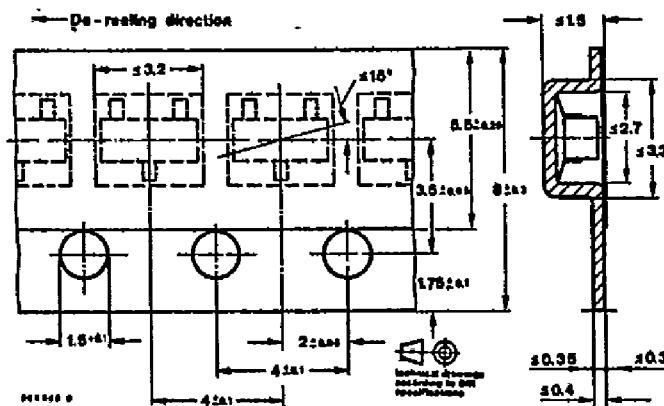

Fig. 7.7 Dimensions of tape in mm

b) Reverse taping

Designation is attached with code GS 07 in case of reverse taping. Example for normal version transistors as reverse taped: BF 569 R-GS 07. Example for R-version transistors as reverse taping: BF 569 R-GS 07.

In case of reverse taping, the transistor orientation on the tape is shown in Fig. 6. Regarding MOF-FET and MES-FET devices, reverse taping is at present not available.

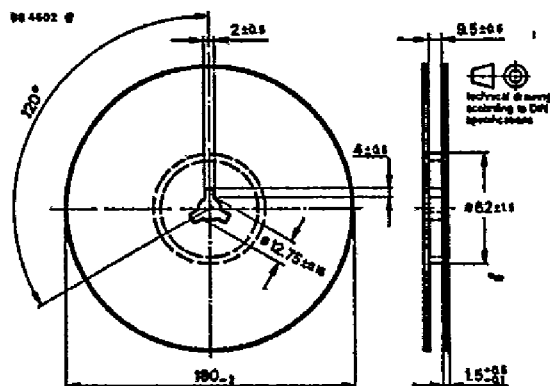

Fig. 7.8 Dimensions of reel in mm

8. Accessories

Number	Fig.	Designation
119880	8.1.	Isolating washer thickness 60 μ m
564542	8.2.	Isolating washer thickness 50 μ m
912884	8.3	Isolating washer thickness 50 μ m
191131	8.4	Isolating washer thickness 50 μ m
191140	8.5	Mounting clip
569524	8.6	Isolating washer thickness 100 μ m + 50 μ m

7.2.2 Quantity of devices

3000 devices per reel

For case

- 12A 3 DIN 41 869
- JEDEC TO 126 (SOT 32)
- 14A 3 DIN 41 869
- JEDEC TO 220 (SOT 78)
- 15A 3 DIN 41 869
- (TOP3) for clip mounting
- 15A 3 DIN 41 869
- (TOP3) for screw mounting
- 15A 3 DIN 41 869
- (TOP3)
- 3B 2 DIN 41 872
- JEDEC TO 3
- Devices with high reverse voltage