

RF POWER MOSFET

N-CHANNEL ENHANCEMENT MODE

165 V 150 W 100 MHz

The ARF520 is an RF power transistor designed for high voltage operation in narrow band ISM and MRI power amplifiers up to 100 MHz.

- **Specified 125 Volt, 81 MHz Characteristics:**
 - Output Power = 150 Watts.**
 - Gain = 13dB (Class AB)**
 - Efficiency = 50%**
- **High Voltage Breakdown and Large SOA for Superior Ruggedness.**
- **Industry standard package**
- **Low Vth thermal coefficient**

MAXIMUM RATINGS

All Ratings: $T_C = 25^\circ\text{C}$ unless otherwise specified.

Symbol	Parameter	ARF520	UNIT
V_{DSS}	Drain-Source Voltage	500	Volts
I_D	Continuous Drain Current @ $T_C = 25^\circ\text{C}$	10	Amps
V_{GS}	Gate-Source Voltage	± 30	Volts
P_D	Total Device Dissipation @ $T_C = 25^\circ\text{C}$	250	Watts
T_J, T_{STG}	Operating and Storage Junction Temperature Range	-55 to 200	°C
T_L	Lead Temperature: 0.063" from Case for 10 Sec.	300	

STATIC ELECTRICAL CHARACTERISTICS

Symbol	Characteristic / Test Conditions	MIN	TYP	MAX	UNIT
BV_{DSS}	Drain-Source Breakdown Voltage ($V_{GS} = 0V, I_D = 250 \mu\text{A}$)	500			Volts
$V_{DS(ON)}$	On State Drain Voltage ① ($I_{D(ON)} = 5A, V_{GS} = 10V$)			4	
I_{DSS}	Zero Gate Voltage Drain Current ($V_{DS} = V_{DSS}, V_{GS} = 0V$)			25	μA
	Zero Gate Voltage Drain Current ($V_{DS} = 50V, V_{GS} = 0, T_C = 125^\circ\text{C}$)			250	
I_{GSS}	Gate-Source Leakage Current ($V_{GS} = \pm 30V, V_{DS} = 0V$)			± 100	nA
g_{fs}	Forward Transconductance ($V_{DS} = 25V, I_D = 5A$)	4	6		mhos
$V_{GS(TH)}$	Gate Threshold Voltage ($V_{DS} = V_{GS}, I_D = 50mA$)	3		5	Volts

THERMAL CHARACTERISTICS

Symbol	Characteristic	MIN	TYP	MAX	UNIT
$R_{\theta JC}$	Junction to Case			0.7	°C/W
$R_{\theta CS}$	Case to Sink (Use High Efficiency Thermal Joint Compound and Planar Heat Sink Surface.)		0.1		



CAUTION: These Devices are Sensitive to Electrostatic Discharge. Proper Handling Procedures Should Be Followed.

DYNAMIC CHARACTERISTICS

ARF520

Symbol	Characteristic	Test Conditions	MIN	TYP	MAX	UNIT
C_{iss}	Input Capacitance	$V_{GS} = 0V$ $V_{DS} = 50V$ $f = 1\text{ MHz}$		800	1200	pF
C_{oss}	Output Capacitance			140	200	
C_{rss}	Reverse Transfer Capacitance			9	12	
$t_{d(on)}$	Turn-on Delay Time	$V_{GS} = 15V$ $V_{DD} = 0.5 V_{DSS}$ $I_D = I_{D[Cont.]} @ 25^\circ C$ $R_G = 1.6 \Omega$		5.1	10	ns
t_r	Rise Time			4.1	8	
$t_{d(off)}$	Turn-off Delay Time			12.8	20	
t_f	Fall Time			4.0	8	

FUNCTIONAL CHARACTERISTICS (Push-Pull Configuration)

Symbol	Characteristic	Test Conditions	MIN	TYP	MAX	UNIT
G_{PS}	Common Source Amplifier Power Gain	$f = 81\text{ MHz}$	13	14		dB
η	Drain Efficiency	$I_{dq} = 50\text{ mA}$ $V_{DD} = 125\text{ V}$	50	55		%
Ψ	Electrical Ruggedness VSWR 5:1	$P_{out} = 150\text{ W}$	No Degradation in Output Power			

① Pulse Test: Pulse width < 380 μs , Duty Cycle < 2%.

APT Reserves the right to change, without notice, the specifications and information contained herein.

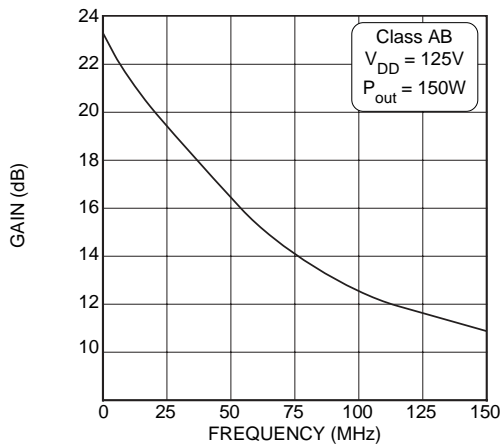

Figure 1, Typical Gain vs. Frequency

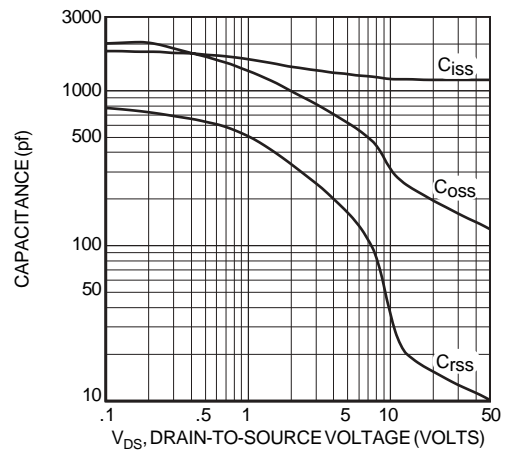

Figure 2, Typical Capacitance vs. Drain-to-Source Voltage

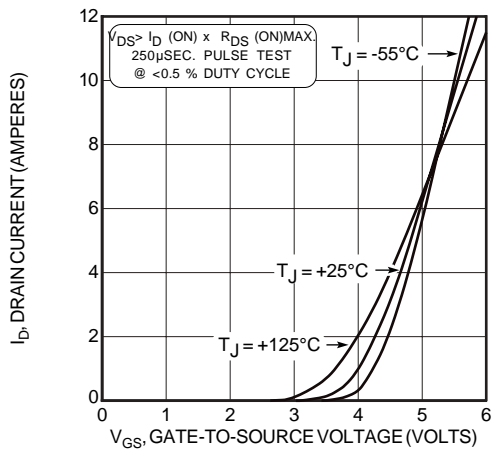

Figure 3, Typical Transfer Characteristics

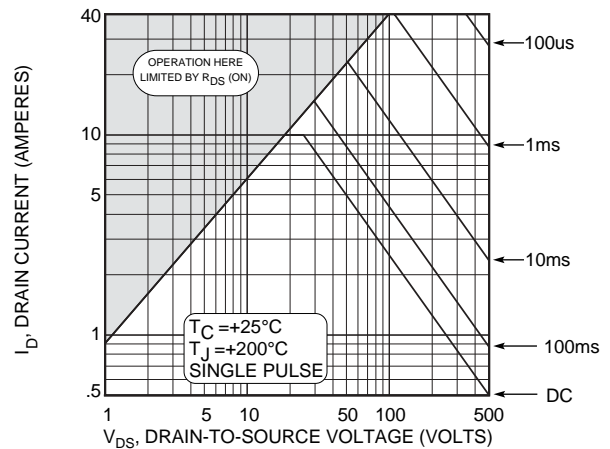

Figure 4, Typical Maximum Safe Operating Area

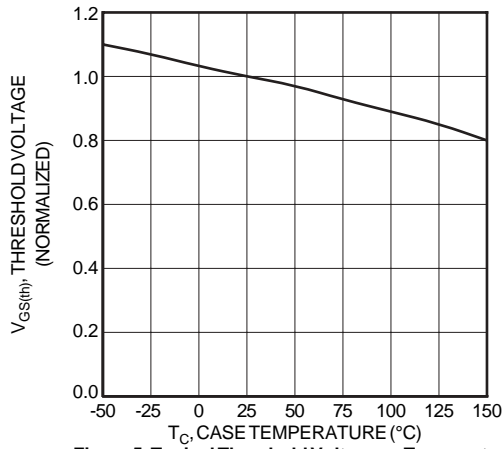

Figure 5, Typical Threshold Voltage vs Temperature

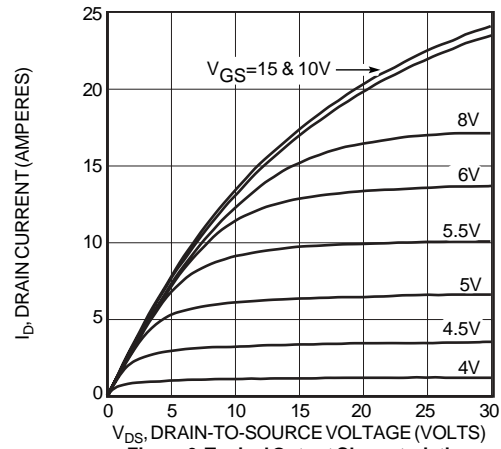

Figure 6, Typical Output Characteristics

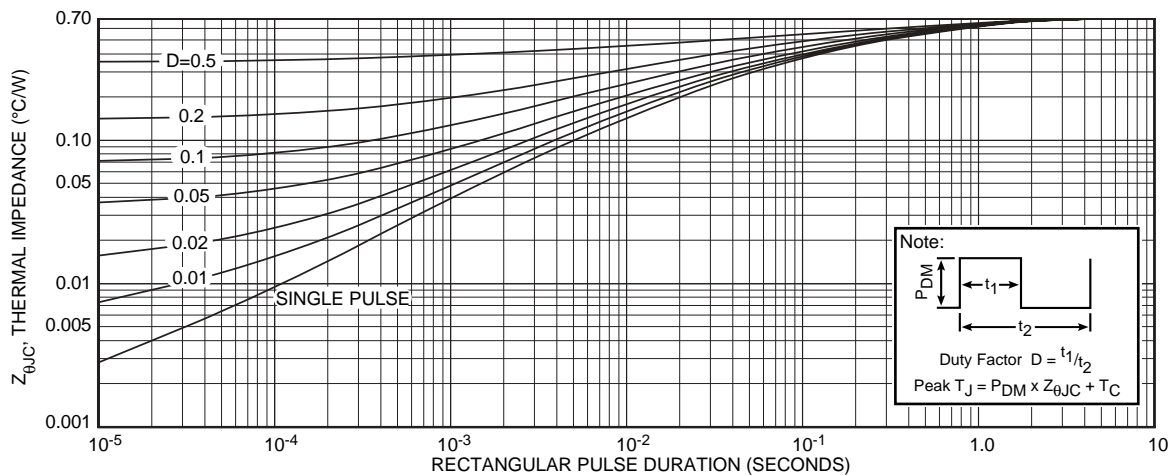

Figure 7, Maximum Effective Transient Thermal Impedance, Junction-to-Case vs. Pulse Duration

Table 1 - Typical Class AB Large Signal Input - Output Impedance

Freq. (MHz)	Z _{in} (Ω)	Z _{OL} (Ω)
2.0	24 - j 4.5	55 - j 4
13.5	8.3 - j 11.6	45 - j 22
27	2.5 - j 7.1	28.7 - j 28
40	1.0 - j 4.2	17.9 - j 26
65	.30 - j 1.1	9.0 - j 20.6
80	.25 + j 0.3	5.8 - j 17
100	.35 + j 1.6	4 - j 14.2

Z_{in} - Gate shunted with 25Ω

I_{dq} = 50mA

Z_{OL} - Conjugate of optimum load for 150 Watts output at V_{dd} = 125V

ARF520

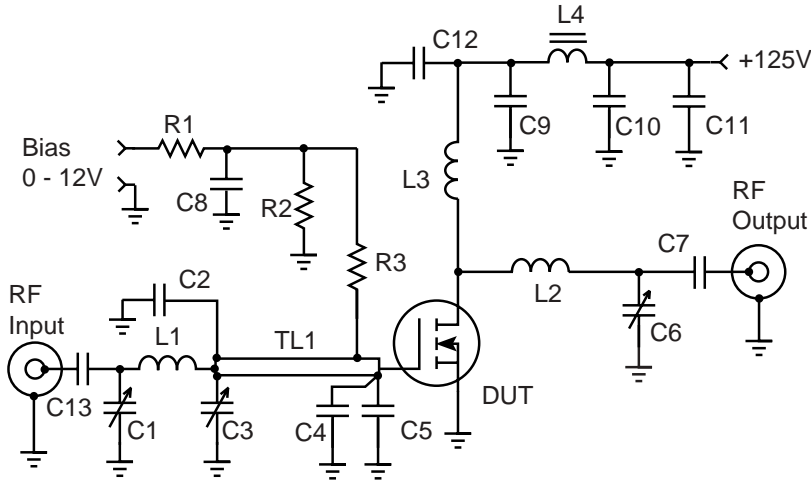

81.36 MHz Test Circuit

- C1 - Arco 406 Mica trimmer
- C2 - 220pF Semco metal clad
- C3 - Arco 464 Mica trimmer
- C4 - 820 pF ATC 700B
- C5- 1000 pF ATC 700B
- C6 - Arco 463 Mica trimmer
- C7-C10 10nF 500V chip
- C11-C13 1nF NPO 500V
- TL1 - .23" x 1.5" stripline
- L1 -- 2t #18 .3" ID .2"L ~50nH
- L2 -- 3t #16 AWG .31" ID .3"L ~65nH
- L3 -- 10t #22 AWG .25 ID ~470nH
- L4 -- VK200-4B ferrite choke ~3uH
- R1-R3 -- 1k Ohm 1/4W Carbon
- DUT = ARF520

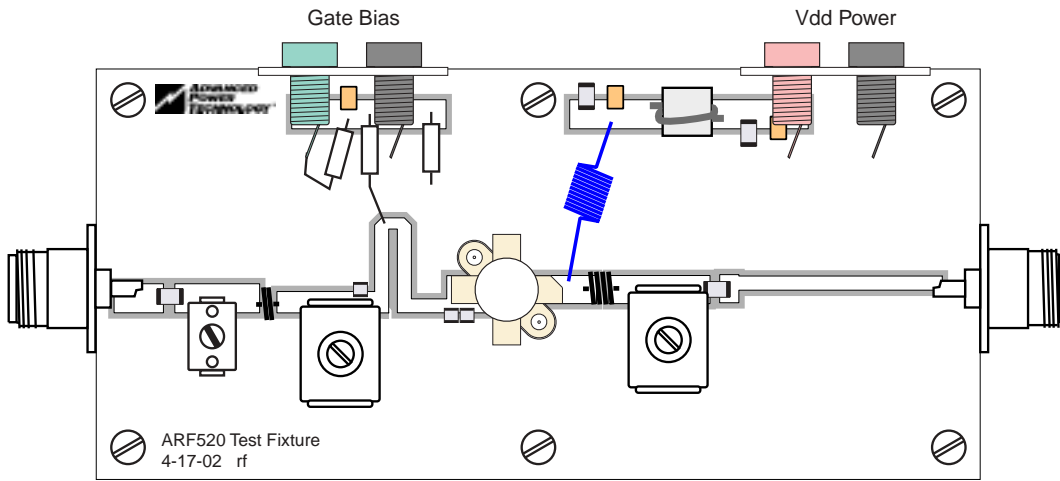

HAZARDOUS MATERIAL WARNING

The ceramic portion of the device between leads and mounting surface is beryllium oxide, BeO. Beryllium oxide dust is toxic when inhaled. Care must be taken during handling and mounting to avoid damage to this area. These devices must never be thrown away with general industrial or domestic waste.

.5" SOE Package Outline

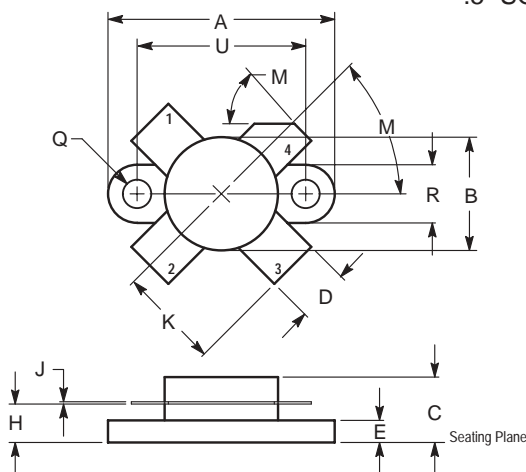

- PIN 1. SOURCE
- 2. GATE
- 3. SOURCE
- 4. DRAIN

DIM	INCHES		MILLIMETERS	
	MIN	MAX	MIN	MAX
A	0.960	0.990	24.39	25.14
B	0.465	0.510	11.82	12.95
C	0.229	0.275	5.82	6.98
D	0.216	0.235	5.49	5.96
E	0.084	0.110	2.14	2.79
H	0.144	0.178	3.66	4.52
J	0.003	0.007	0.08	0.17
K	0.435		11.0	
M	45'	NOM	45'	NOM
Q	0.115	0.130	2.93	3.30
R	0.246	0.255	6.25	6.47
U	0.720	0.730	18.29	18.54

Controlling Dimension: INCH.