

## MEMS INERTIAL SENSOR: 2-Axis - $\pm 2g/\pm 6g$ LINEAR ACCELEROMETER

### 1 Features

- 2.4V TO 5.25V SINGLE SUPPLY OPERATION
- LOW POWER CONSUMPTION
- $\pm 2g/\pm 6g$  USER SELECTABLE FULL-SCALE
- 0.3mg RESOLUTION OVER 100Hz BANDWIDTH
- EMBEDDED SELF TEST AND POWER DOWN
- OUTPUT VOLTAGE, OFFSET AND SENSITIVITY RATIO METRIC TO THE SUPPLY VOLTAGE
- HIGH SHOCK SURVIVABILITY
- LEAD FREE AND ECOPACK COMPATIBLE

### 2 Description

The LIS2L02AS4 is a low-power two axes linear accelerometer that includes a sensing element and an IC interface able to take the information from the sensing element and to provide an analog signal to the external world.

The sensing element, capable of detecting the acceleration, is manufactured using a dedicated process developed by ST to produce inertial sensors and actuators in silicon.

The IC interface is manufactured using a standard CMOS process that allows high level of integration to design a dedicated circuit which is trimmed to better match the sensing element characteristics.

The LIS2L02AS4 has a user selectable full scale

Figure 1. Package

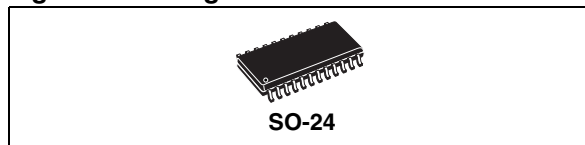

Table 1. Order Codes

Part Number	Package	Finishing
E-LIS2L02AS4	SO24	Tube
E-LIS2L02AS4TR	SO24	Tape & Reel

of  $\pm 2g$ ,  $\pm 6g$  and it is capable of measuring accelerations over a bandwidth of 1.5kHz for all axes. The device bandwidth may be reduced by using external capacitances. A self-test capability allows to check the mechanical and electrical signal path of the sensor.

The LIS2L02AS4 is available in plastic SMD package and it is specified over an extended temperature range of  $-40^{\circ}\text{C}$  to  $+85^{\circ}\text{C}$ .

The LIS2L02AS4 belongs to a family of products suitable for a variety of applications:

- Mobile terminals
- Gaming and Virtual Reality input devices
- Free-fall detection for data protection
- Antitheft systems and Inertial Navigation
- Appliance and Robotics

Figure 2. Block Diagram

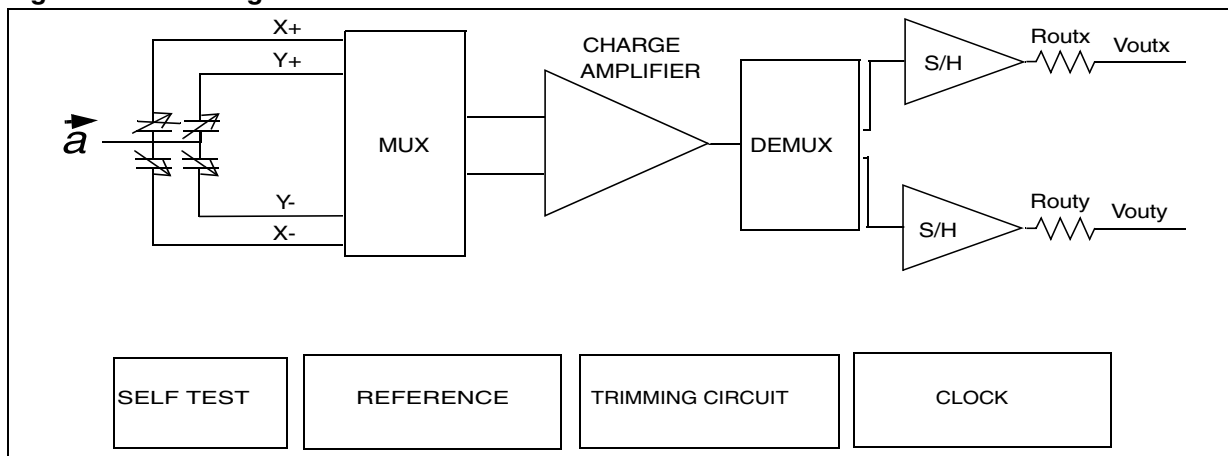

**Table 2. Pin Description**

N°	Pin	Function
1 to 5	NC	Internally not connected
6	GND	0V supply
7	Vdd	Power supply
8	Vouty	Output Voltage
9	ST	Self Test (Logic 0: normal mode; Logic 1: Self-test)
10	Voutx	Output Voltage
11	PD	Power Down (Logic 0: normal mode; Logic 1: Power-Down mode)
12	NC	Internally not connected
13	FS	Full Scale selection (Logic 0: 2g Full-scale; Logic 1: 6g Full-scale)
14-15	Reserved	Leave unconnected or connect to Vdd
16	Reserved	Connect to Vdd or ground
17	Reserved	Leave unconnected or connect to Vdd
18	Reserved	Leave unconnected or connect to ground
19 to 24	NC	Internally not connected

**Figure 3. Pin Connection (Top view)**

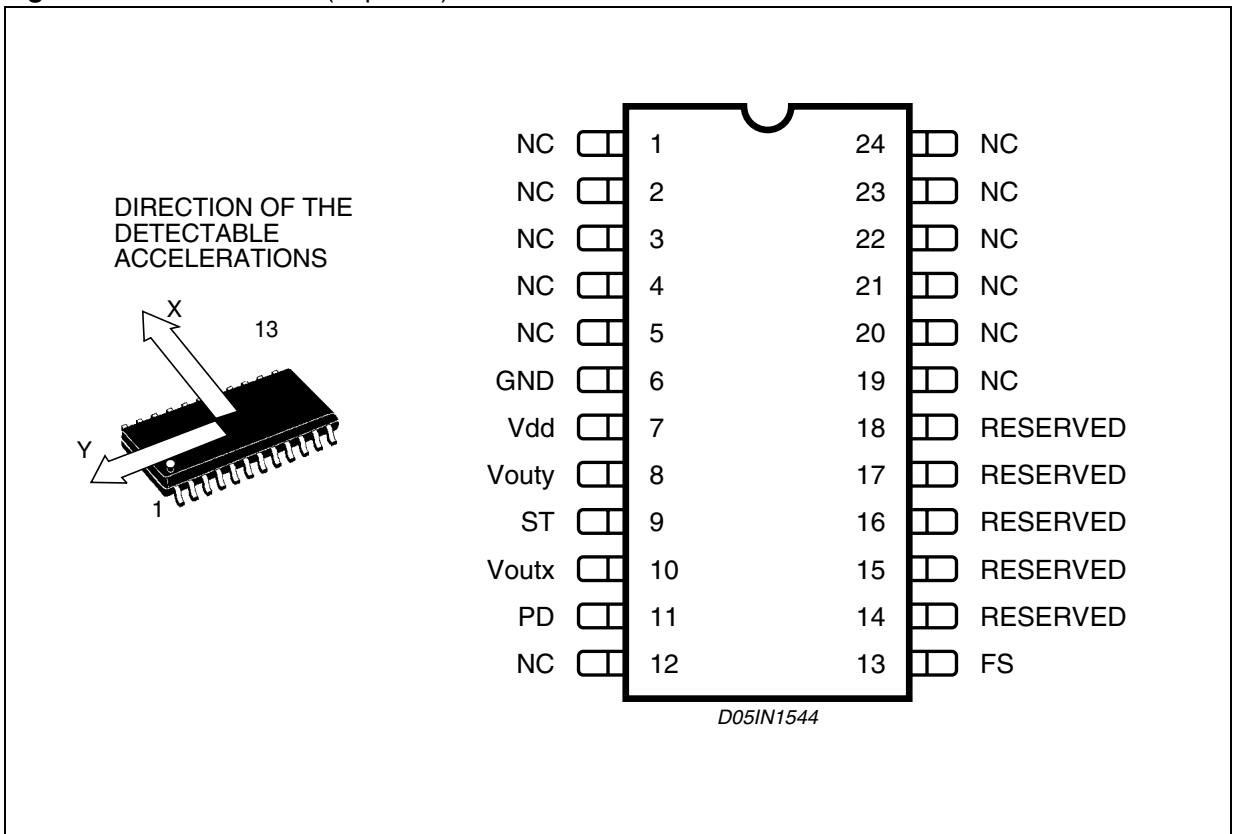

**Table 3. Mechanical Characteristics<sup>1</sup>**

(Temperature range -40°C to +85°C). All the parameters are specified @ Vdd =3.3V, T=25°C unless otherwise noted

Symbol	Parameter	Test Condition	Min.	Typ. <sup>2</sup>	Max.	Unit
Ar	Acceleration Range <sup>3</sup>	FS pin connected to GND	±1.8	±2.0		g
		FS pin connected to Vdd	±5.4	±6.0		g
So	Sensitivity <sup>4</sup>	Full-scale = 2g	Vdd/5-10%	Vdd/5	Vdd/5+10%	V/g
		Full-scale = 6g	Vdd/15-10%	Vdd/15	Vdd/15+10%	V/g
SoDr	Sensitivity Change Vs Temperature	Delta from +25°C		±0.01		%/°C
Voff	Zero-g Level <sup>4</sup>	T = 25°C	Vdd/2-10%	Vdd/2	Vdd/2+10%	V
OffDr	Zero-g level Change Vs Temperature	Delta from +25°C		±0.2		mg/°C
NL	Non Linearity <sup>5</sup>	Best fit straight line Full-scale = 2g X, Y axis		±0.3	±1.5	% FS
CrossAx	Cross-Axis <sup>6</sup>			±2	±4	%
An	Acceleration Noise Density	Vdd=3.3V; Full-scale = 2g		30		µg/√Hz
Vt	Self test Output Voltage Change <sup>7,8,9</sup>	T = 25°C Vdd=3.3V Full-scale = 2g X axis	-20	-50	-100	mV
		T = 25°C Vdd=3.3V Full-scale = 2g Y axis	20	50	100	mV
Fres	Sensing Element Resonance Frequency <sup>10</sup>	all axes	1.5			kHz
Top	Operating Temperature Range		-40		+85	°C
Wh	Product Weight			0.6		gram

Notes: 1. The product is factory calibrated at 3.3V. The device can be powered from 2.4V to 5.25V. Voff, So and Vt parameters will vary with supply voltage.

2. Typical specifications are not guaranteed

3. Verified by wafer level test and measurement of initial offset and sensitivity

4. Zero-g level and sensitivity are essentially ratiometric to supply voltage

5. Guaranteed by design

6. Contribution to the measuring output of an inclination/acceleration along any perpendicular axis

7. "Self test output voltage change" is defined as  $V_{out}(V_{st=Logic1}) - V_{out}(V_{st=Logic0})$

8. "Self test output voltage change" varies cubically with supply voltage

9. When full-scale is set to ±6g, "self-test output voltage change" is one third of the specified value.

10. Minimum resonance frequency  $F_{res}=1.5\text{kHz}$ . Sensor bandwidth= $1/(2*\pi*110\text{K}\Omega*C_{load})$  with  $C_{load}>1\text{nF}$ .

**Table 4. Electrical Characteristics<sup>1</sup>**

(Temperature range -40°C to +85°C) All the parameters are specified @ Vdd =3.3V, T=25°C unless otherwise noted

Symbol	Parameter	Test Condition	Min.	Typ. <sup>2</sup>	Max.	Unit
Vdd	Supply Voltage		2.4	3.3	5.25	V
Idd	Supply Current	mean value PD pin connected to GND		0.85	1.5	mA
IddPdn	Supply Current in Power Down Mode	rms value PD pin connected to Vdd		2	5	μA
Vst	Self Test Input	Logic 0 level	0		0.8	V
		Logic 1 level	2.2		Vdd	V
Rout	Output Impedance		80	110	140	kΩ
Cload	Capacitive Load Drive <sup>3</sup>		320			pF
Ton	Turn-On Time at exit from Power Down mode	Cload in μF		550*Cload+0.3		ms

Notes: 1. The product is factory calibrated at 3.3V.

2. Typical specifications are not guaranteed

3. Minimum resonance frequency  $F_{res}=1.5\text{kHz}$ . Sensor bandwidth= $1/(2*\pi*110\text{K}\Omega*Cload)$  with  $Cload>1\text{nF}$

### 3 Absolute Maximum Rating

Stresses above those listed as “absolute maximum ratings” may cause permanent damage to the device. This is a stress rating only and functional operation of the device under these conditions is not implied. Exposure to maximum rating conditions for extended periods may affect device reliability.

**Table 5. Absolute Maximum Rating**

Symbol	Ratings	Maximum Value	Unit
Vdd	Supply Voltage	-0.3 to 7	V
Vin	Input Voltage on any control pin (FS, PD, ST)	-0.3 to Vdd +0.3	V
A <sub>POW</sub>	Acceleration (Any axis, Powered, Vdd=3.3V)	3000g for 0.5 ms	
		10000g for 0.1 ms	
A <sub>UNP</sub>	Acceleration (Any axis, Not powered)	3000g for 0.5 ms	
		10000g for 0.1 ms	
T <sub>STG</sub>	Storage Temperature Range	-40 to +125	°C
ESD	Electrostatic Discharge Protection	2 (HBM)	kV
		200 (MM)	V
		1500 (CDM)	V



This is a Mechanical Shock sensitive device, improper handling can cause permanent damages to the part



This is an ESD sensitive device, improper handling can cause permanent damages to the part

## 3.1 Terminology

### 3.1.1 Sensitivity

Describes the gain of the sensor and can be determined by applying 1g acceleration to it. As the sensor can measure DC accelerations this can be done easily by pointing the axis of interest towards the center of the earth, note the output value, rotate the sensor by 180 degrees (point to the sky) and note the output value again thus applying  $\pm 1g$  acceleration to the sensor. Subtracting the larger output value from the smaller one and dividing the result by 2 will give the actual sensitivity of the sensor. This value changes very little over temperature (see sensitivity change vs. temperature) and also very little over time. The Sensitivity Tolerance describes the range of Sensitivities of a large population of sensors.

### 3.1.2 Zero-g level

Describes the actual output signal if there is no acceleration present. A sensor in a steady state on an horizontal surface will measure 0g in X axis and 0g in Y axis whereas the Z axis will measure +1g. The output is ideally for a 3.3V powered sensor  $V_{dd}/2 = 1650mV$ . A deviation from ideal 0-g level (1650mV in this case) is called Zero-g offset. Offset of precise MEMS sensors is to some extent a result of stress to the sensor and therefore the offset can slightly change after mounting the sensor onto a printed circuit board or exposing it to extensive mechanical stress. Offset changes little over temperature - see "Zero-g Level Change vs. Temperature" - the Zero-g level of an individual sensor is very stable over lifetime. The Zero-g level tolerance describes the range of zero-g levels of a population of sensors.

### 3.1.3 Self Test

Self Test allows to test the mechanical and electric part of the sensor, allowing the seismic mass to be moved by means of an electrostatic test-force. The Self Test function is off when the ST pin is connected to GND. When the ST pin is tied at Vdd an actuation force is applied to the sensor, simulating a definite input acceleration. In this case the sensor outputs will exhibit a voltage change in their DC levels which is related to the selected full scale and depending on the Supply Voltage through the device sensitivity. When ST is activated, the device output level is given by the algebraic sum of the signals produced by the acceleration acting on the sensor and by the electrostatic test-force. If the output signals change within the amplitude specified inside Table 3, then the sensor is working properly and the parameters of the interface chip are within the defined specification.

### 3.1.4 Output impedance

Describes the resistor inside the output stage of each channel. This resistor is part of a filter consisting of an external capacitor of at least 320pF and the internal resistor. Due to the high resistor level only small, inexpensive external capacitors are needed to generate low corner frequencies. When interfacing with an ADC it is important to use high input impedance input circuitries to avoid measurement errors. Note that the minimum load capacitance forms a corner frequency beyond the resonance frequency of the sensor. For a flat frequency response a corner frequency well below the resonance frequency is recommended. In general the smallest possible bandwidth for an particular application should be chosen to get the best results.

## **4 Functionality**

The LIS2L02AS4 is a high performance, low-power, analog output two axes linear accelerometer packaged in a SO24 package. The complete device includes a sensing element and an IC interface able to take the information from the sensing element and to provide an analog signal to the external world.

### **4.1 Sensing element**

A proprietary process is used to create a surface micro-machined accelerometer. The technology allows to carry out suspended silicon structures which are attached to the substrate in a few points called anchors and are free to move in the direction of the sensed acceleration. To be compatible with the traditional packaging techniques a cap is placed on top of the sensing element to avoid blocking the moving parts during the moulding phase of the plastic encapsulation.

When an acceleration is applied to the sensor the proof mass displaces from its nominal position, causing an imbalance in the capacitive half-bridge. This imbalance is measured using charge integration in response to a voltage pulse applied to the sense capacitor.

At steady state the nominal value of the capacitors are few pF and when an acceleration is applied the maximum variation of the capacitive load is up to 100fF.

### **4.2 IC Interface**

In order to increase robustness and immunity against external disturbances the complete signal processing chain uses a fully differential structure. The final stage converts the differential signal into a single-ended one to be compatible with the external world.

The signals of the sensing element are multiplexed and fed into a low-noise capacitive charge amplifier that implements a Correlated Double Sampling (CDS) at its output to cancel the offset and the 1/f noise. The output signal is de-multiplexed and transferred to two different S&Hs, one for each channel and made available to the outside.

The low noise input amplifier operates at 200 kHz while the two S&Hs operate at a sampling frequency of 66 kHz. This allows a large oversampling ratio, which leads to in-band noise reduction and to an accurate output waveform.

All the analog parameters (zero-g level, sensitivity and self-test) are ratiometric to the supply voltage. Increasing or decreasing the supply voltage, the sensitivity and the offset will increase or decrease almost linearly. The self test voltage change varies cubically with the supply voltage.

### **4.3 Factory calibration**

The IC interface is factory calibrated for Sensitivity ( $S_0$ ) and Zero-g Level ( $V_{off}$ ). The trimming values are stored inside the device by a non volatile structure. Any time the device is turned on, the trimming parameters are downloaded into the registers to be employed during the normal operation. This allows the user to employ the device without further calibration.

## 5 Application hints

Figure 4. LIS2L02AS4 Electrical Connection

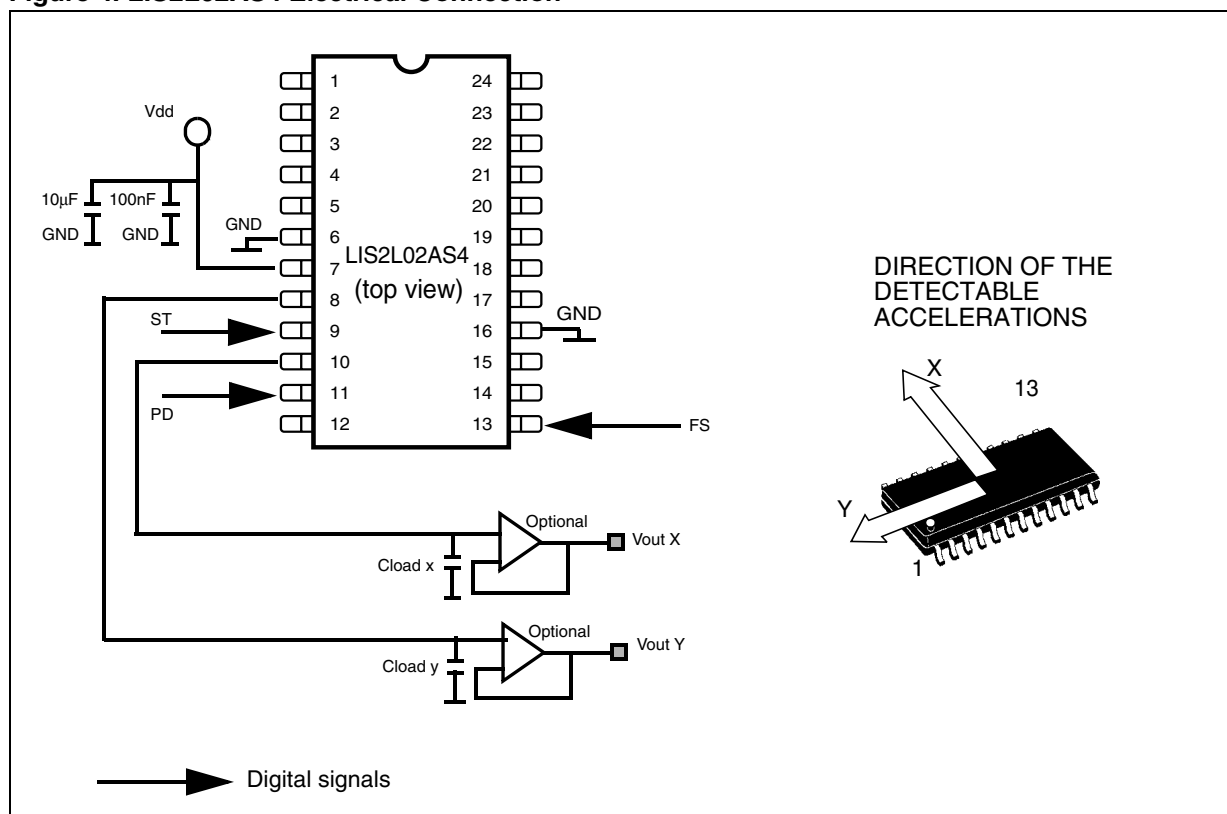

Power supply decoupling capacitors (100nF ceramic + 10µF Al) should be placed as near as possible to the device (common design practice).

The LIS2L02AS4 allows to band limit Voutx, Vouty through the use of external capacitors. The recommended frequency range spans from DC up to 1.5 kHz. In particular, capacitors must be added at output pins to implement low-pass filtering for antialiasing and noise reduction. The equation for the cut-off frequency ( $f_t$ ) of the external filters is:

$$f_t = \frac{1}{2\pi \cdot R_{out} \cdot C_{load}(x, y)}$$

Taking in account that the internal filtering resistor ( $R_{out}$ ) has a nominal value equal to 110kΩ, the equation for the external filter cut-off frequency may be simplified as follows:

$$f_t = \frac{1.45\mu\text{F}}{C_{load}(x, y)} [\text{Hz}]$$

The tolerance of the internal resistor can vary typically of  $\pm 20\%$  within its nominal value of 110kΩ, thus the cut-off frequency will vary accordingly. A minimum capacitance of 320 pF for  $C_{load}(x, y)$  is required in any case.

Table 6. Filter Capacitor Selection,  $C_{load}(x,y,z)$ . Capacitance Value Choose.

Cut-off frequency	Capacitor value
1 Hz	1500nF
10 Hz	150nF
50 Hz	30 nF
100 Hz	15 nF
200 Hz	6.8 nF
500 Hz	3 nF

### 5.1 Soldering information

The SO24 package is lead free qualified for soldering heat resistance according to JEDEC J-STD-020C.

### 5.2 Output response vs orientation

Figure 5. Output response vs orientation

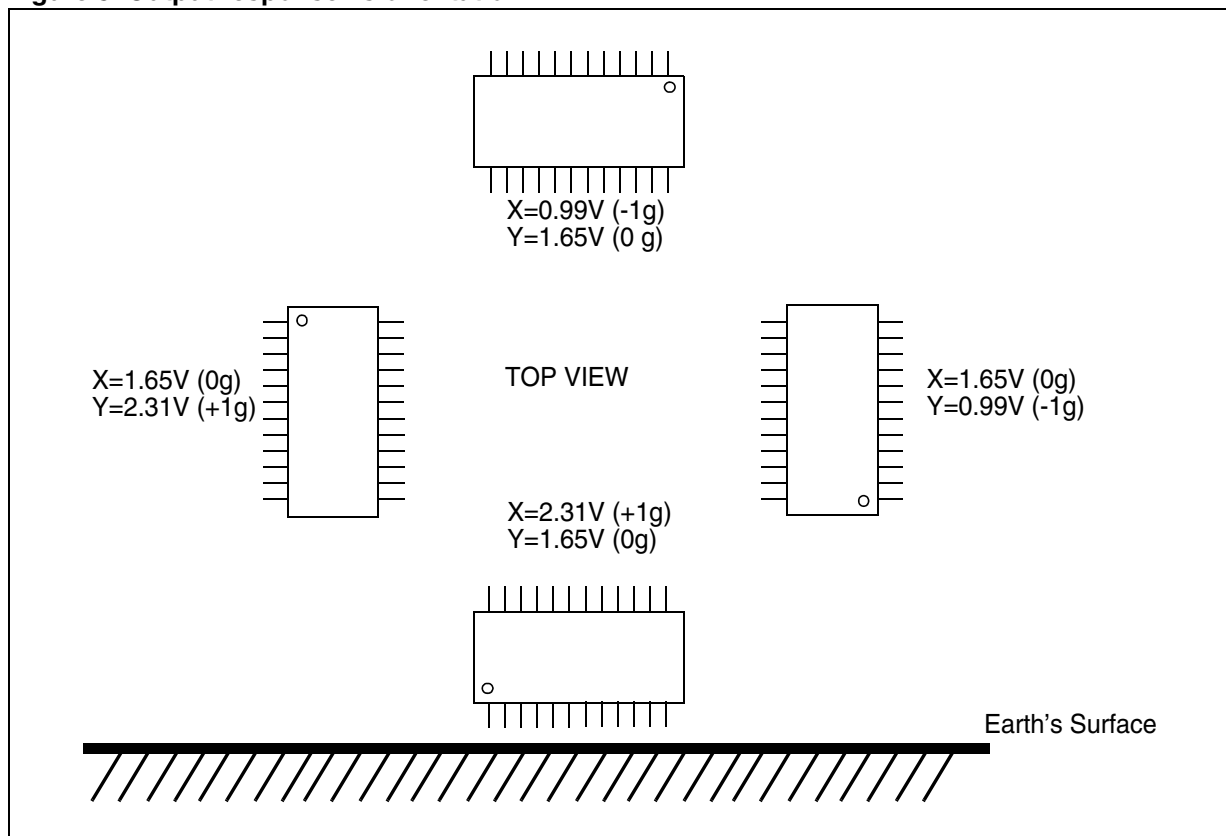

Figure 5 refers to LIS2L02AS4 device powered at 3.3V



## 6 Typical performance Characteristics

### 6.1 Mechanical Characteristics at 25°C

Figure 6. X axis Zero g Level at 3.3V

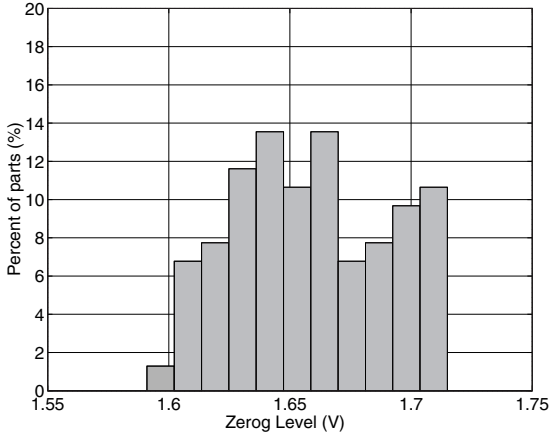

Figure 8. X axis Sensitivity at 3.3V

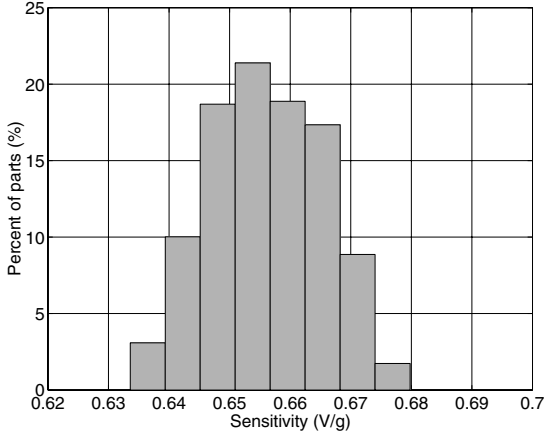

Figure 7. Y axis Zero g Level at 3.3V

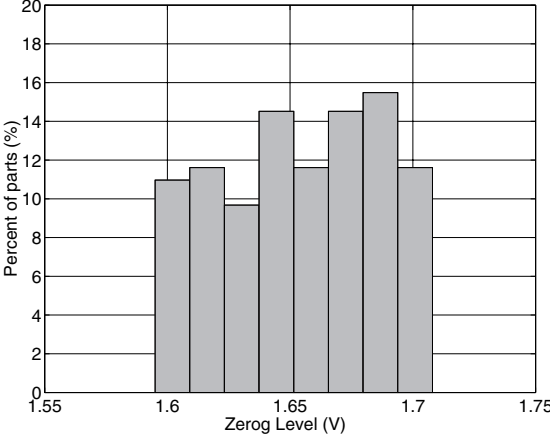
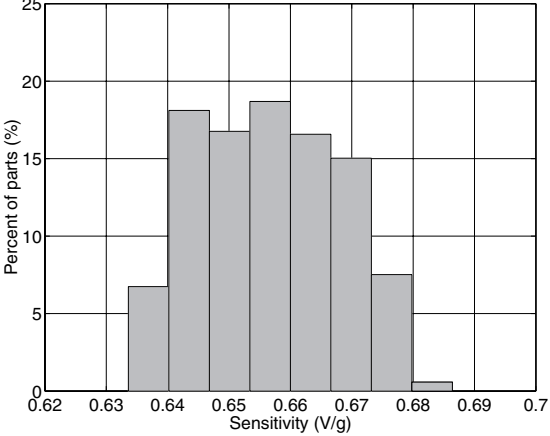

Figure 9. Y axis Sensitivity at 3.3V



6.2 Mechanical Characteristics derived from measurement in the -40°C to +85°C temperature range

Figure 10. X axis Zero g Level Change Vs. Temperature

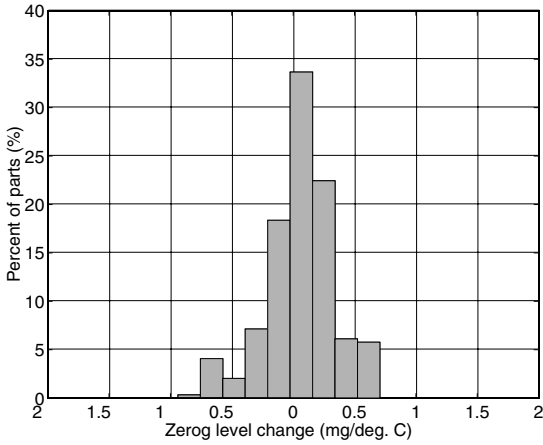

Figure 12. X axis Sensitivity Change Vs. Temperature

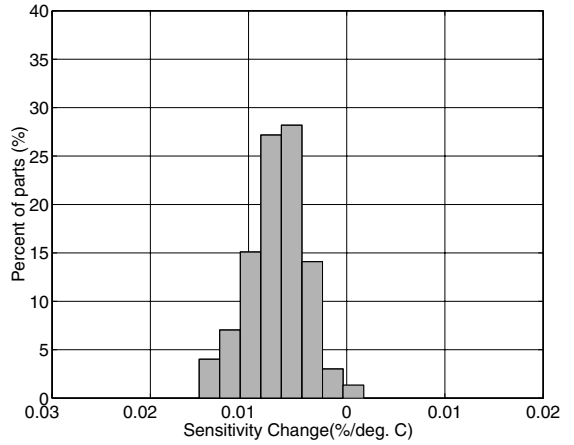

Figure 11. Y axis Zero g Level Change Vs. Temperature

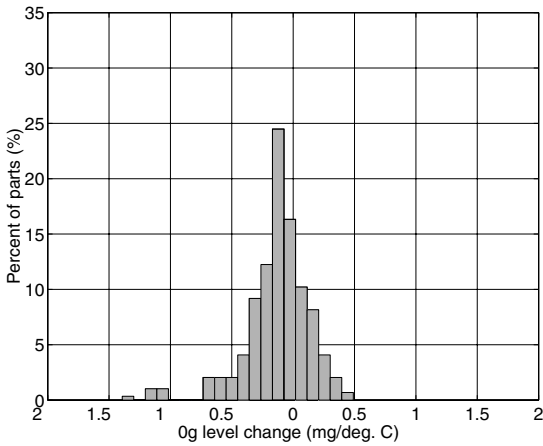
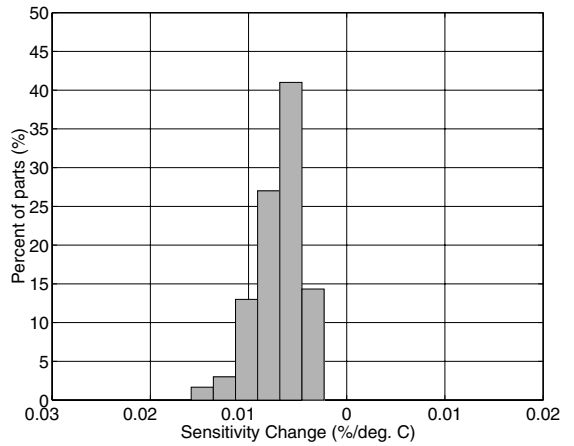
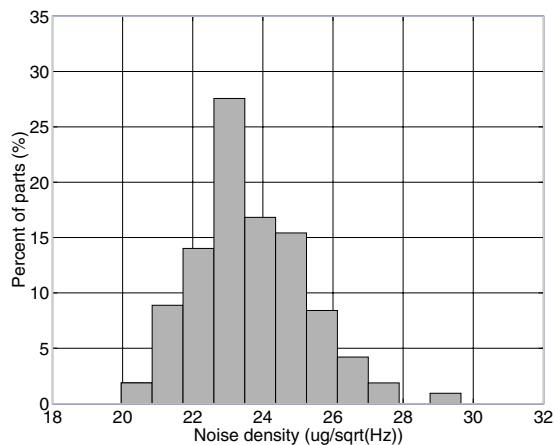

Figure 13. Y axis Sensitivity Change Vs. Temperature



### 6.3 Electrical Characteristics at 25°C

**Figure 14. Noise density at 3.3V**



**Figure 16. Current consumption in power down mode at 3.3V**

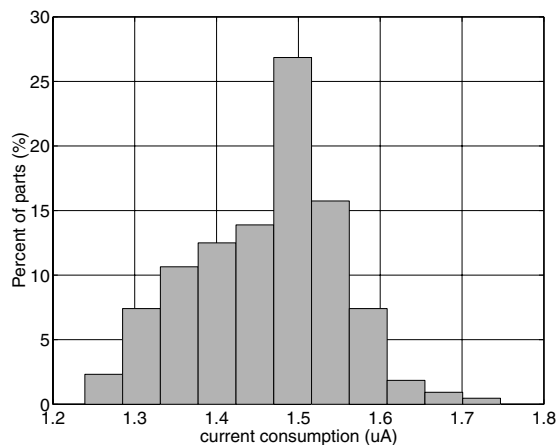

**Figure 15. Current consumption at 3.3V**

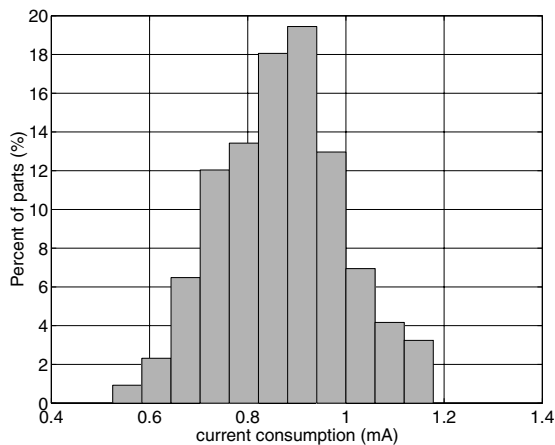

## 7 Package Information

In order to meet environmental requirements, ST offers these devices in ECOPACK<sup>®</sup> packages. These packages have a Lead-free second level interconnect. The category of second Level Interconnect is marked on the package and on the inner box label, in compliance with JEDEC Standard JESD97. The maximum ratings related to soldering conditions are also marked on the inner box label.

ECOPACK is an ST trademark. ECOPACK specifications are available at: [www.st.com](http://www.st.com).

Figure 17. SO24 Mechanical Data & Package Dimensions

DIM.	mm			inch		
	MIN.	TYP.	MAX.	MIN.	TYP.	MAX.
A	2.35		2.65	0.093		0.104
A1	0.10		0.30	0.004		0.012
B	0.33		0.51	0.013		0.200
C	0.23		0.32	0.009		0.013
D (1)	15.20		15.60	0.598		0.614
E	7.40		7.60	0.291		0.299
e		1.27			0.050	
H	10.0		10.65	0.394		0.419
h	0.25		0.75	0.010		0.030
L	0.40		1.27	0.016		0.050
k	0° (min.), 8° (max.)					
ddd			0.10			0.004

**OUTLINE AND MECHANICAL DATA**

Weight: 0.60gr

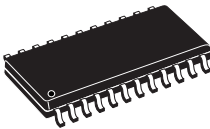

SO24

(1) "D" dimension does not include mold flash, protusions or gate burrs. Mold flash, protusions or gate burrs shall not exceed 0.15mm per side.

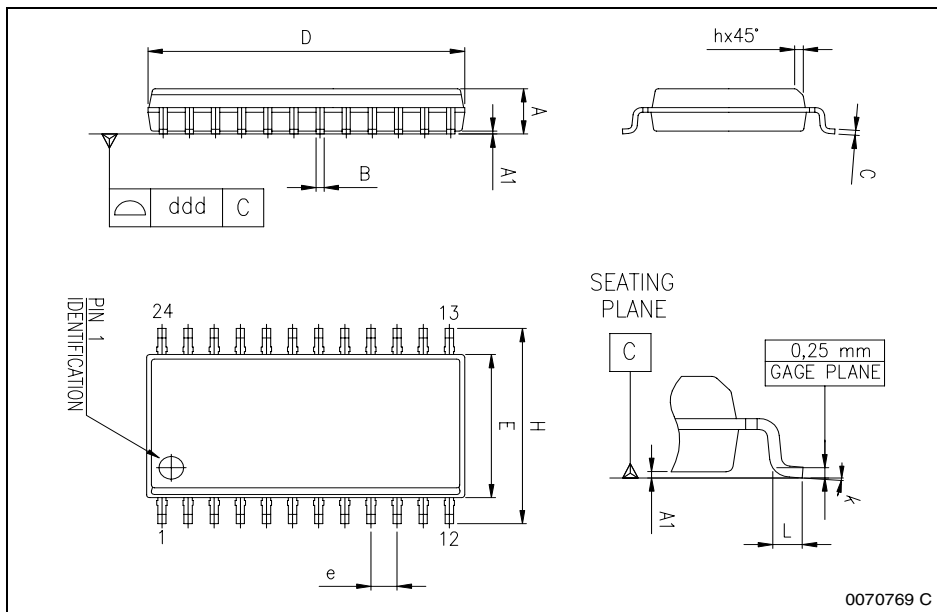

## 8 Revision History

**Table 7. Revision History**

<b>Date</b>	<b>Revision</b>	<b>Description of Changes</b>
February 2004	1	First issue
1-Dec-2005	2	Changed from Product preview to Datasheet maturity. Added Typical performance Characteristics section.

Information furnished is believed to be accurate and reliable. However, STMicroelectronics assumes no responsibility for the consequences of use of such information nor for any infringement of patents or other rights of third parties which may result from its use. No license is granted by implication or otherwise under any patent or patent rights of STMicroelectronics. Specifications mentioned in this publication are subject to change without notice. This publication supersedes and replaces all information previously supplied. STMicroelectronics products are not authorized for use as critical components in life support devices or systems without express written approval of STMicroelectronics.

The ST logo is a registered trademark of STMicroelectronics.  
All other names are the property of their respective owners

© 2005 STMicroelectronics - All rights reserved

STMicroelectronics group of companies

Australia - Belgium - Brazil - Canada - China - Czech Republic - Finland - France - Germany - Hong Kong - India - Israel - Italy - Japan -  
Malaysia - Malta - Morocco - Singapore - Spain - Sweden - Switzerland - United Kingdom - United States of America

[www.st.com](http://www.st.com)