

ショットキーバリアダイオード

SCHOTTKY BARRIER DIODE

■特長：Features

- 低 V_F
Low V_F
- スイッチングスピードが非常に速い
Super high speed switching.
- プレーナー技術による高信頼性
High reliability by planer design.

■用途：Applications

- 高速電力スイッチング
High speed power switching.

■外形寸法：Outline Drawings

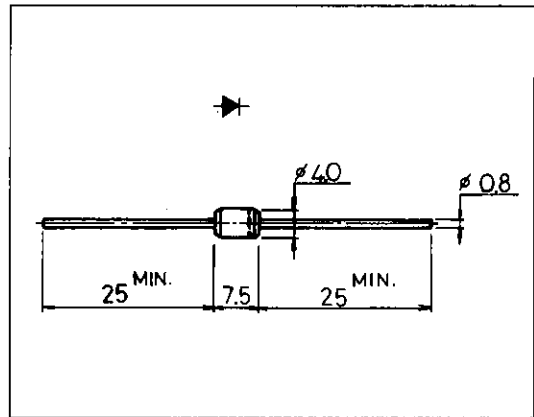

■表示：Marking

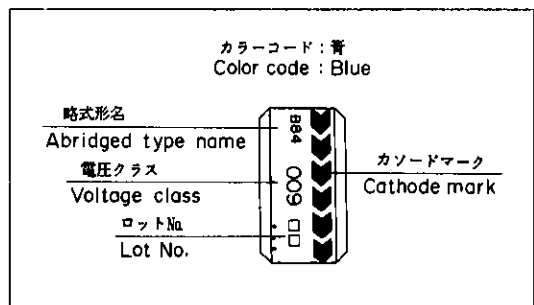

■定格と特性：Maximum Ratings and Characteristics

●絶対最大定格：Absolute Maximum Ratings

Items	Symbols	Conditions	Ratings	Units
ピーク繰り返し逆電圧 Repetitive Peak Reverse Voltage	V_{RRM}		90	V
平均順電流 Average Forward Current	$I_{F(AV)}$	方形波, duty = $\frac{1}{2}$, $T_a = 25^\circ\text{C}$ Square wave	2.0*	A
サージ電流 Surge Current	I_{FSM}	正弦波 10ms Sine wave	60	A
接合温度 Operating Junction Temperature	T_j		-40 ~ +125	$^\circ\text{C}$
保存温度 Storage Temperature	T_{stg}		-40 ~ +125	$^\circ\text{C}$

*20×20は銅フィンを両側につけ6場合

* With cooling Cu fin both lead (1t×20×20)

●電気的特性(特に指定がない限り周囲温度 $T_a = 25^\circ\text{C}$ とする)

Electrical Characteristics ($T_a = 25^\circ\text{C}$ Unless otherwise specified)

Items	Symbols	Conditions	Max.	Units
順電圧 Forward Voltage Drop	V_{FM}	$I_{FM} = 2.0\text{A}$	0.9	V
逆電流 Reverse Current	I_{RRM}	$V_R = V_{RRM}$	2.0	mA

■特性曲線：Characteristics

A

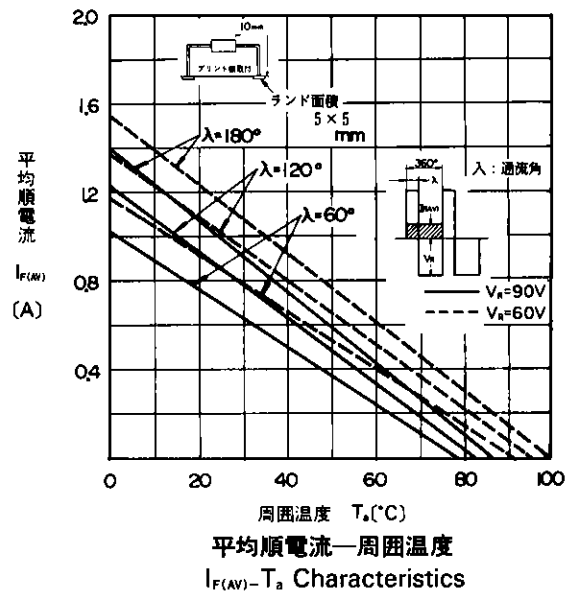
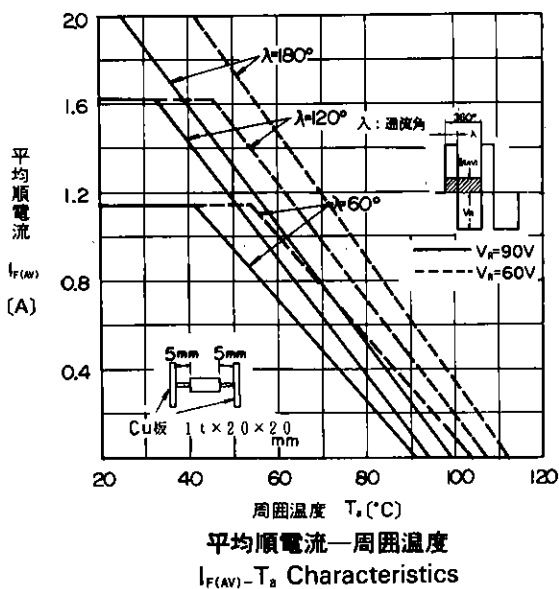
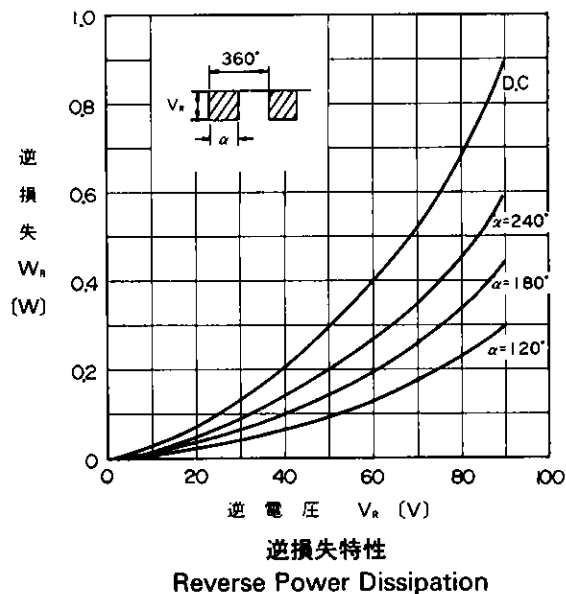
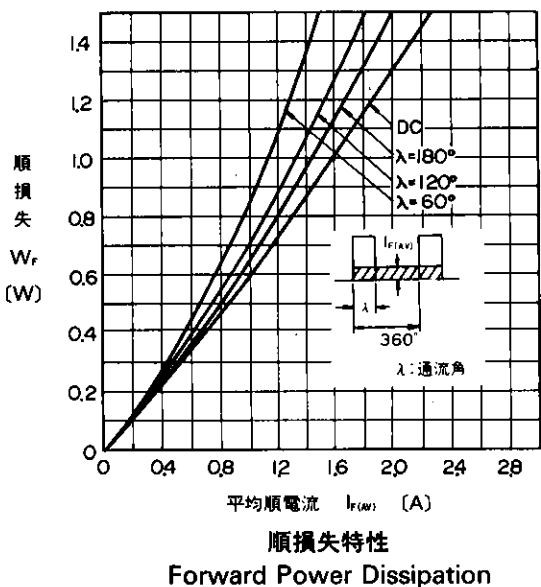
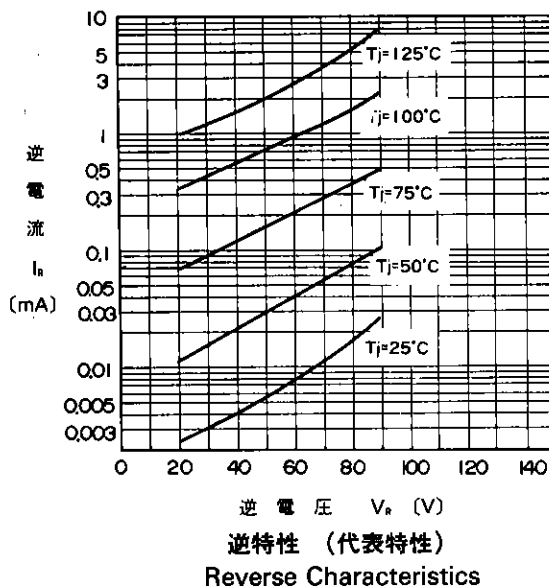
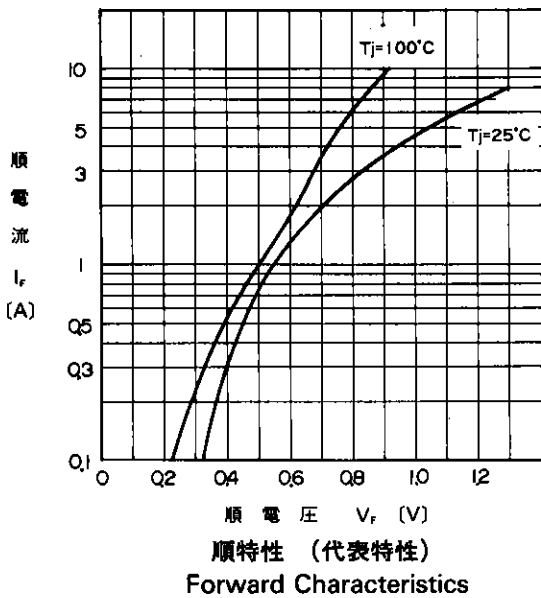

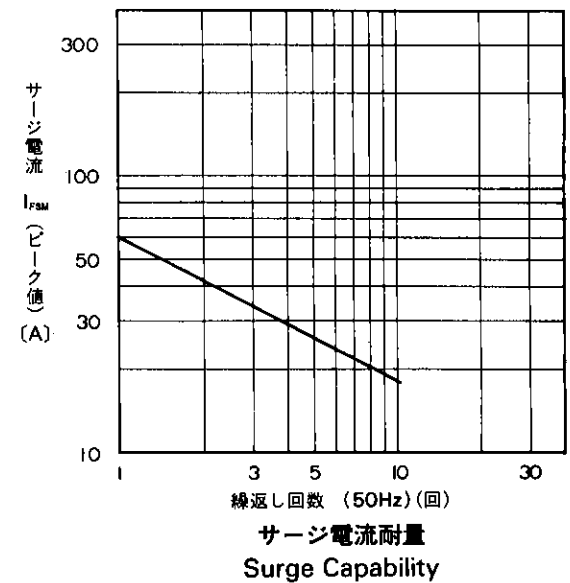
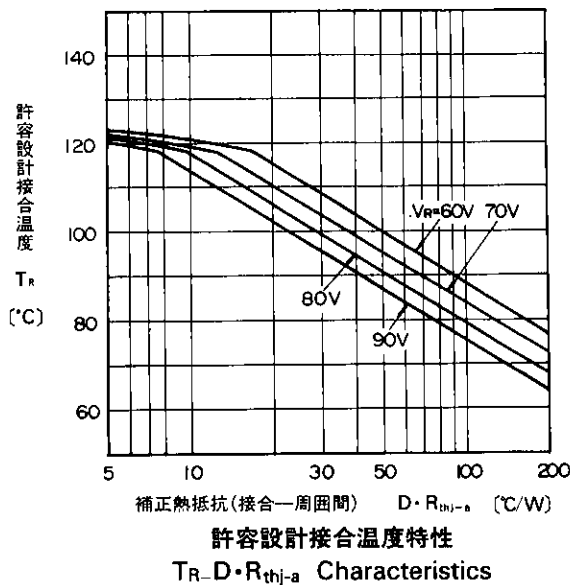
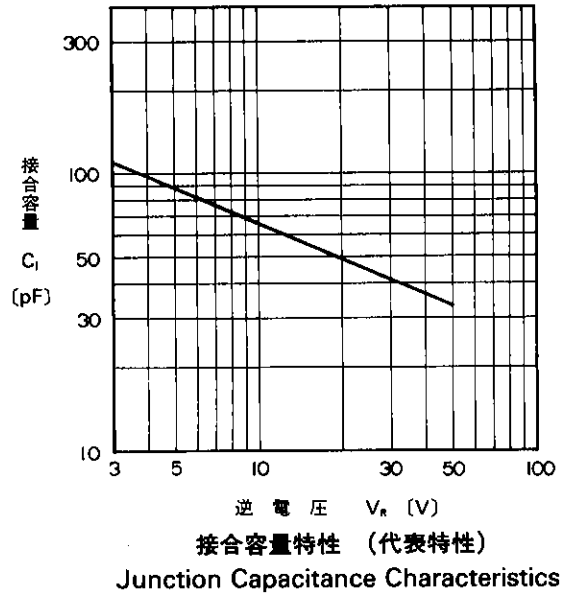
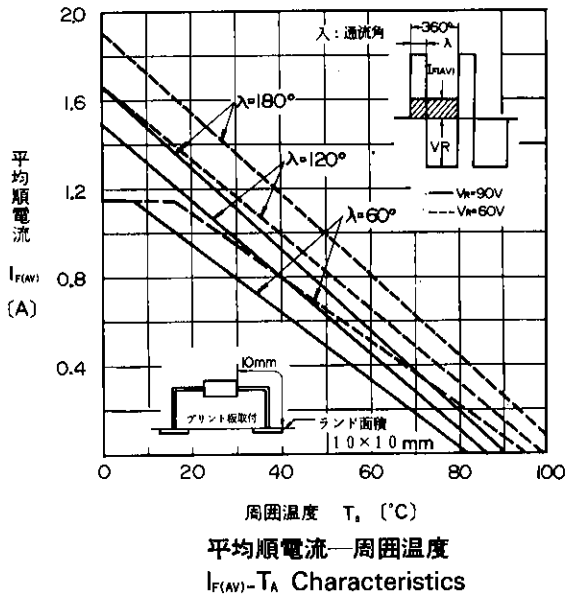

T_R : 許容設計接合温度
 T_A : 周囲温度
 V_R : ピーク逆電圧
 R_{thj-a} : 接合-周囲間熱抵抗
 D : 逆電圧duty

許容順損失 (pF) $\leq \frac{T_R - T_A}{R_{thj-a}}$

(例) ピーク逆電圧60Vピーク,
 逆電圧duty=2/3 ($D=2/3$), $R_{thj-a}=80^\circ\text{C/W}$ のとき
 $D \cdot R_{thj-a} = 2/3 \times 80 = 53^\circ\text{C/W}$
 上図より許容周囲温度は, $T_a = 98^\circ\text{C}$ となる。
 故に順損失は, $T_a = 60^\circ\text{C}$ の時

$P_F = \frac{98 - 60}{80} = 0.47\text{W}$

順電流duty=1/3ならば, 許容順電流は,
 $I_{F(AV)} = 0.70\text{A}$ (順損失特性より)

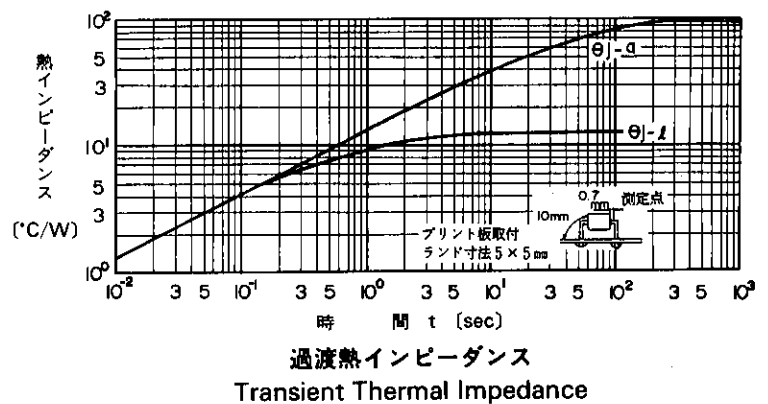

For more information, contact:

Collmer Semiconductor, Inc.

P.O. Box 702708

Dallas, TX 75370

972-733-1700

972-381-9991 Fax

<http://www.collmer.com>