

# A37

## D-SUB IDC FEMALE (DUAL U-SLOT)

PITCH: 2.54mm

### SPECIFICATIONS

#### Material

Insulator : PBT, glass reinforced, rated UL 94V-0

Contact : Phosphor Bronze

#### Electrical

Current Rating : 1 Amp DC for # 28AWG Cable

1.5Amp DC for # 26AWG Cable

Contact Resistance : 30 mΩ max.

Insulation Resistance : 3000 MΩ min.

Dielectric Withstanding Voltage : 500V AC for 1minute

Operating Temperature : -40°C to +105°C

♦ Terminated with 1.27mm pitch flat ribbon cable.

♦ Mating Suggestion : E07, E09, E10 & E11 series.

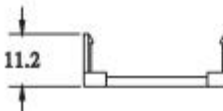
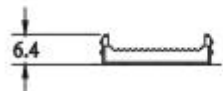
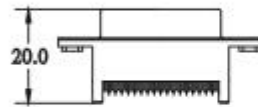
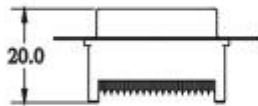
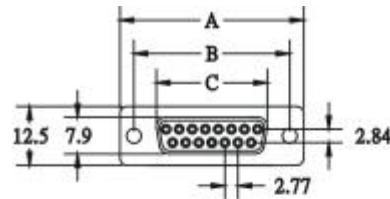
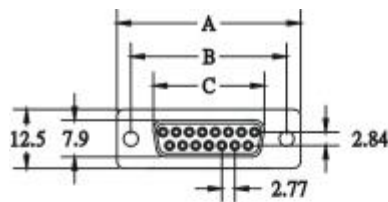
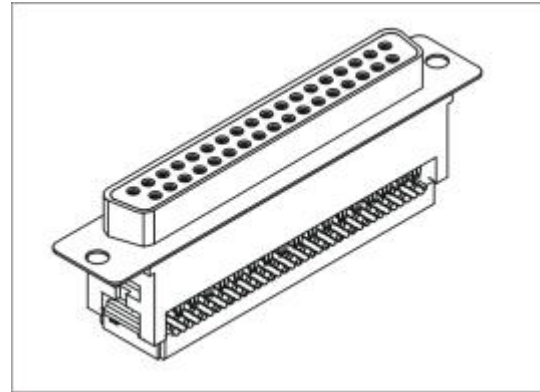

POSITION	A	B	C
9	30.80	25.00	16.30
15	39.20	33.30	24.60
25	53.05	47.04	38.30
37	69.40	63.50	54.80

### HOW TO ORDER:

A37 -  1 -  2 -  3 -  4 -  5 -  6 -  7

1.NO. OF CONTACT	2.CONTACT TYPE	3.CONTACT PLATING	4.SHELL
09 15 25 37	F: FEMALE	T: TIN PLATED S: SELECTIVE G: GOLD FLASH A: 5μ" INCH GOLD B: 10μ" INCH GOLD C: 15μ" INCH GOLD D: 30μ" INCH GOLD	A: METAL
5.MOUNTING METHOD	6.ACCESSORIES	7.INSULATOR COLOR	
A: THROUGH HOLE B: THREAD INSERT 4-40 UNC C: THREAD INSERT M3	A: W STRAIN RELIEF B: W/O STRAIN RELIEF	1. BLACK 2. GREY 3. BLUE	