

**Applications**

- High frequency DC-DC converters

<b>V<sub>DSS</sub></b>	<b>R<sub>DS(on) max</sub></b>	<b>I<sub>D</sub></b>
<b>200V</b>	<b>0.17Ω</b>	<b>16A</b>

**Benefits**

- Low Gate-to-Drain Charge to Reduce Switching Losses
- Fully Characterized Capacitance Including Effective C<sub>OSS</sub> to Simplify Design, (See App. Note AN1001)
- Fully Characterized Avalanche Voltage and Current

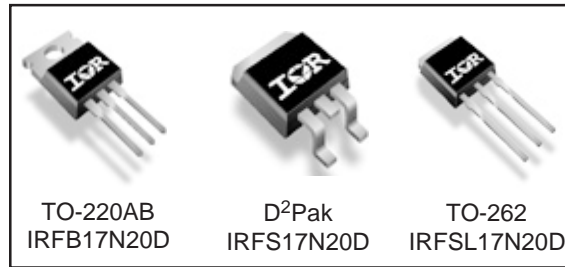

**Absolute Maximum Ratings**

	Parameter	Max.	Units
I <sub>D</sub> @ T <sub>C</sub> = 25°C	Continuous Drain Current, V <sub>GS</sub> @ 10V	16	A
I <sub>D</sub> @ T <sub>C</sub> = 100°C	Continuous Drain Current, V <sub>GS</sub> @ 10V	12	
I <sub>DM</sub>	Pulsed Drain Current ①	64	
P <sub>D</sub> @ T <sub>A</sub> = 25°C	Power Dissipation ②	3.8	W
P <sub>D</sub> @ T <sub>C</sub> = 25°C	Power Dissipation	140	
	Linear Derating Factor	0.90	W/°C
V <sub>GS</sub>	Gate-to-Source Voltage	± 30	V
dv/dt	Peak Diode Recovery dv/dt ③	2.7	V/ns
T <sub>J</sub>	Operating Junction and	-55 to + 175	°C
T <sub>STG</sub>	Storage Temperature Range		
	Soldering Temperature, for 10 seconds	300 (1.6mm from case )	
	Mounting torque, 6-32 or M3 screw ④	10 lbf•in (1.1N•m)	

**Typical SMPS Topologies**

- Telecom 48V input Forward Converter

Notes ① through ⑤ are on page 11

# IRFB/IRFS/IRFSL17N20D

International  
IR Rectifier

Static @  $T_J = 25^\circ\text{C}$  (unless otherwise specified)

	Parameter	Min.	Typ.	Max.	Units	Conditions
$V_{(BR)DSS}$	Drain-to-Source Breakdown Voltage	200	—	—	V	$V_{GS} = 0V, I_D = 250\mu A$
$\Delta V_{(BR)DSS}/\Delta T_J$	Breakdown Voltage Temp. Coefficient	—	0.25	—	V/°C	Reference to $25^\circ\text{C}, I_D = 1\text{mA}$ ⑥
$R_{DS(on)}$	Static Drain-to-Source On-Resistance	—	—	0.17	$\Omega$	$V_{GS} = 10V, I_D = 9.8A$ ④
$V_{GS(th)}$	Gate Threshold Voltage	3.0	—	5.5	V	$V_{DS} = V_{GS}, I_D = 250\mu A$
$I_{DSS}$	Drain-to-Source Leakage Current	—	—	25	$\mu A$	$V_{DS} = 200V, V_{GS} = 0V$
		—	—	250		$V_{DS} = 160V, V_{GS} = 0V, T_J = 150^\circ\text{C}$
$I_{GSS}$	Gate-to-Source Forward Leakage	—	—	100	nA	$V_{GS} = 30V$
	Gate-to-Source Reverse Leakage	—	—	-100		$V_{GS} = -30V$

Dynamic @  $T_J = 25^\circ\text{C}$  (unless otherwise specified)

	Parameter	Min.	Typ.	Max.	Units	Conditions
$g_{fs}$	Forward Transconductance	5.3	—	—	S	$V_{DS} = 50V, I_D = 9.8A$
$Q_g$	Total Gate Charge	—	33	50	nC	$I_D = 9.8A$
$Q_{gs}$	Gate-to-Source Charge	—	8.4	13		$V_{DS} = 160V$
$Q_{gd}$	Gate-to-Drain ("Miller") Charge	—	16	24		$V_{GS} = 10V, ④⑥$
$t_{d(on)}$	Turn-On Delay Time	—	11	—	ns	$V_{DD} = 100V$
$t_r$	Rise Time	—	19	—		$I_D = 9.8A$
$t_{d(off)}$	Turn-Off Delay Time	—	18	—		$R_G = 5.1\Omega$
$t_f$	Fall Time	—	6.6	—		$V_{GS} = 10V$ ④
$C_{iss}$	Input Capacitance	—	1100	—	pF	$V_{GS} = 0V$
$C_{oss}$	Output Capacitance	—	190	—		$V_{DS} = 25V$
$C_{rss}$	Reverse Transfer Capacitance	—	44	—		$f = 1.0\text{MHz}$ ⑥
$C_{oss}$	Output Capacitance	—	1340	—		$V_{GS} = 0V, V_{DS} = 1.0V, f = 1.0\text{MHz}$
$C_{oss}$	Output Capacitance	—	76	—		$V_{GS} = 0V, V_{DS} = 160V, f = 1.0\text{MHz}$
$C_{oss\ eff.}$	Effective Output Capacitance	—	130	—		$V_{GS} = 0V, V_{DS} = 0V \text{ to } 160V$ ⑤

## Avalanche Characteristics

	Parameter	Typ.	Max.	Units
$E_{AS}$	Single Pulse Avalanche Energy ②⑥	—	240	mJ
$I_{AR}$	Avalanche Current ①	—	9.8	A
$E_{AR}$	Repetitive Avalanche Energy ①	—	14	mJ

## Thermal Resistance

	Parameter	Typ.	Max.	Units
$R_{\theta JC}$	Junction-to-Case	—	1.1	°C/W
$R_{\theta CS}$	Case-to-Sink, Flat, Greased Surface ⑥	0.50	—	
$R_{\theta JA}$	Junction-to-Ambient ⑥	—	62	
$R_{\theta JA}$	Junction-to-Ambient ⑦	—	40	

## Diode Characteristics

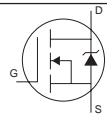
	Parameter	Min.	Typ.	Max.	Units	Conditions
$I_S$	Continuous Source Current (Body Diode)	—	—	16	A	MOSFET symbol showing the integral reverse p-n junction diode. 
$I_{SM}$	Pulsed Source Current (Body Diode) ①⑥	—	—	64		
$V_{SD}$	Diode Forward Voltage	—	—	1.3	V	$T_J = 25^\circ\text{C}, I_S = 9.8A, V_{GS} = 0V$ ④
$t_{rr}$	Reverse Recovery Time	—	160	240	ns	$T_J = 25^\circ\text{C}, I_F = 9.8A$
$Q_{rr}$	Reverse Recovery Charge	—	900	1350	nC	$di/dt = 100A/\mu s$ ④
$t_{on}$	Forward Turn-On Time	Intrinsic turn-on time is negligible (turn-on is dominated by $L_S + L_D$ )				

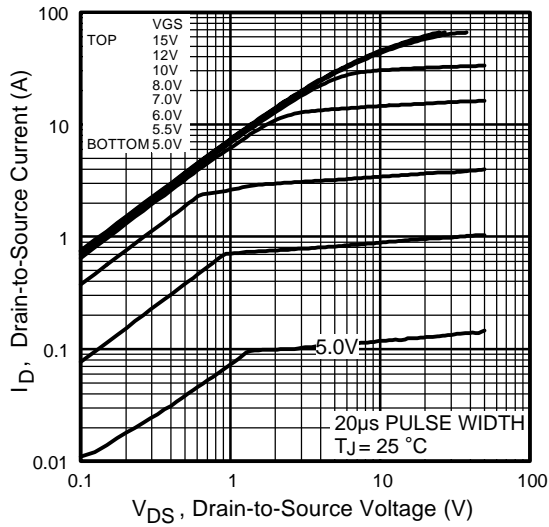

Fig 1. Typical Output Characteristics

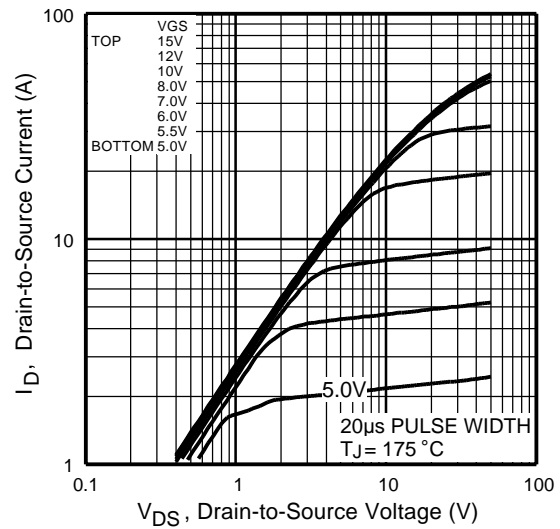

Fig 2. Typical Output Characteristics

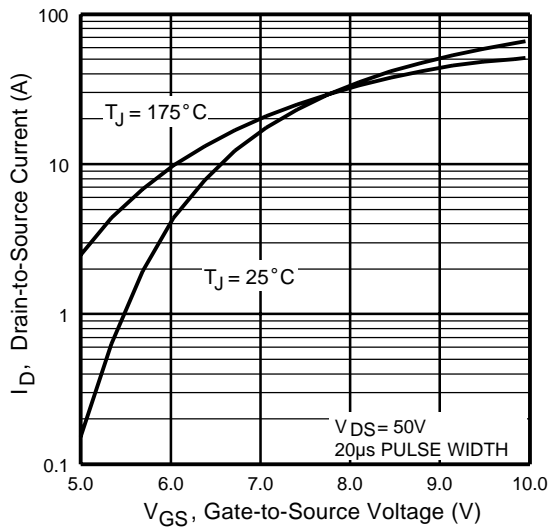

Fig 3. Typical Transfer Characteristics

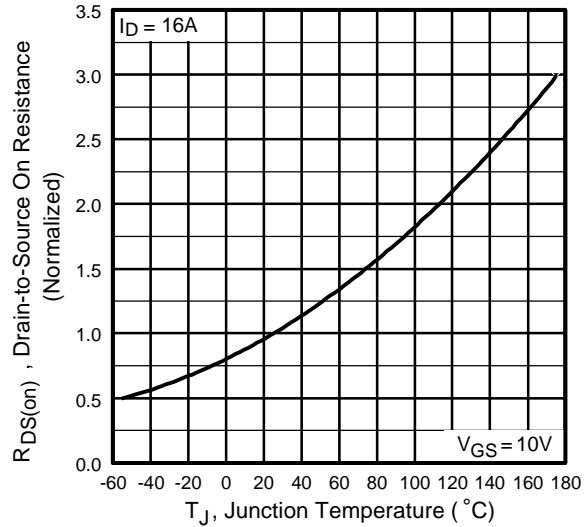
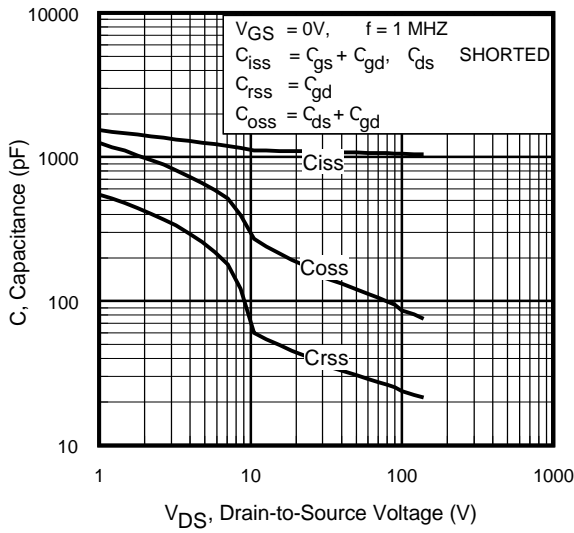
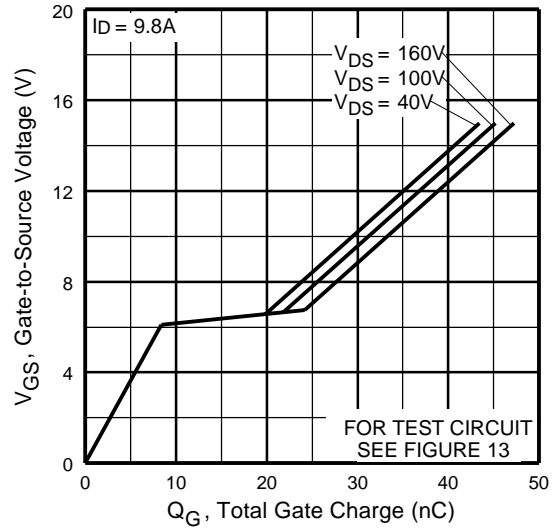

Fig 4. Normalized On-Resistance Vs. Temperature

# IRFB/IRFS/IRFSL17N20D



**Fig 5.** Typical Capacitance Vs. Drain-to-Source Voltage



**Fig 6.** Typical Gate Charge Vs. Gate-to-Source Voltage

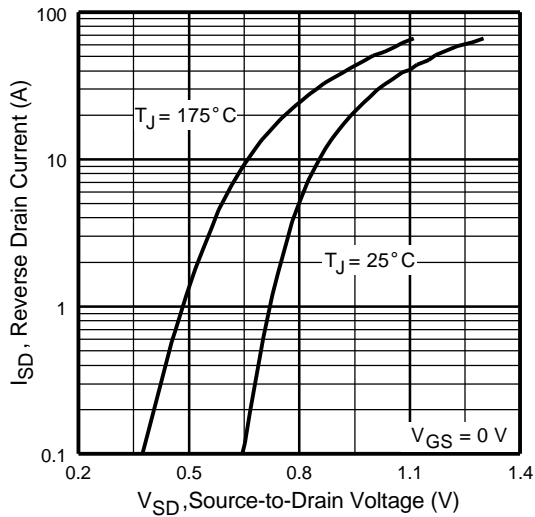

**Fig 7.** Typical Source-Drain Diode Forward Voltage

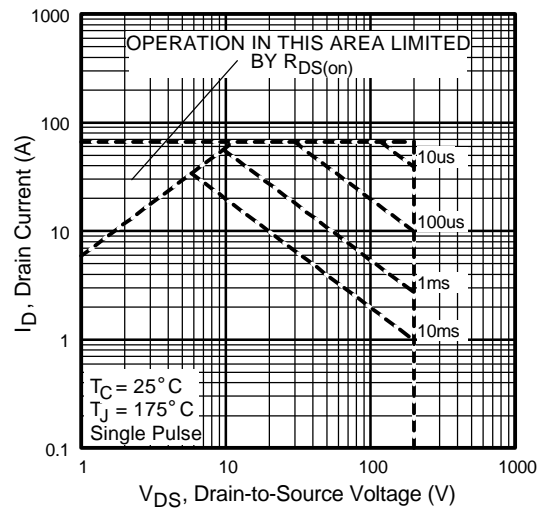

**Fig 8.** Maximum Safe Operating Area

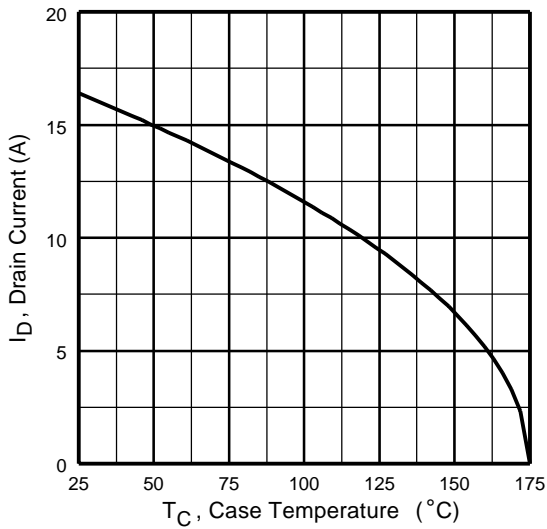

Fig 9. Maximum Drain Current Vs. Case Temperature



Fig 10a. Switching Time Test Circuit



Fig 10b. Switching Time Waveforms

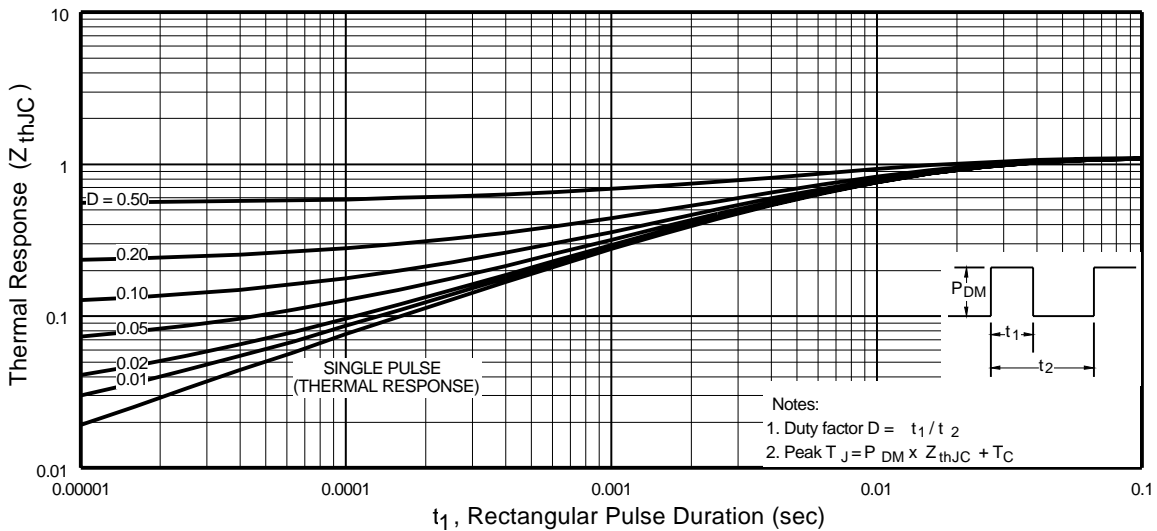

Fig 11. Maximum Effective Transient Thermal Impedance, Junction-to-Case

# IRFB/IRFS/IRFSL17N20D

International  
**IR** Rectifier



**Fig 12a.** Unclamped Inductive Test Circuit



**Fig 12b.** Unclamped Inductive Waveforms

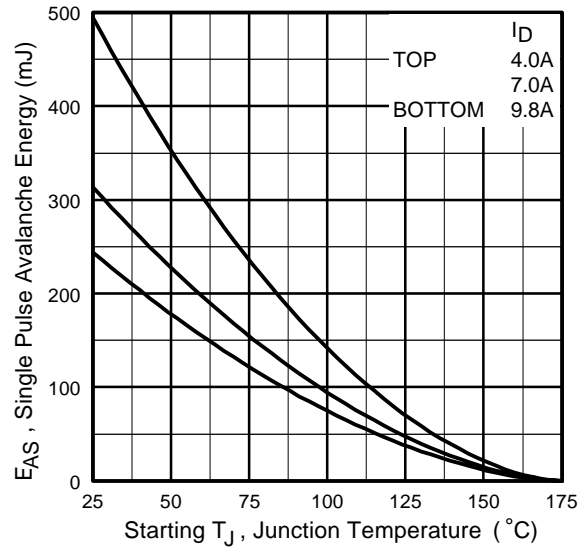

**Fig 12c.** Maximum Avalanche Energy Vs. Drain Current



**Fig 13a.** Basic Gate Charge Waveform

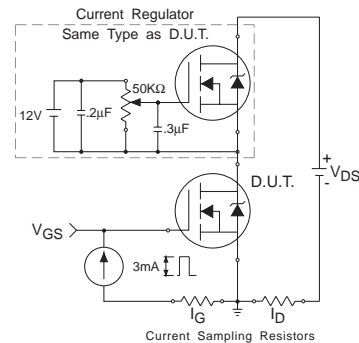

**Fig 13b.** Gate Charge Test Circuit

**Peak Diode Recovery dv/dt Test Circuit**



\*  $V_{GS} = 5V$  for Logic Level Devices

**Fig 14.** For N-Channel HEXFET® Power MOSFETs

# IRFB/IRFS/IRFSL17N20D



## TO-220AB Package Outline

Dimensions are shown in millimeters (inches)



### NOTES:

- 1 DIMENSIONING & TOLERANCING PER ANSI Y14.5M, 1982.
- 2 CONTROLLING DIMENSION : INCH

- 3 OUTLINE CONFORMS TO JEDEC OUTLINE TO-220AB.
- 4 HEATSINK & LEAD MEASUREMENTS DO NOT INCLUDE BURRS.

## TO-220AB Part Marking Information

EXAMPLE : THIS IS AN IRF1010  
WITH ASSEMBLY  
LOT CODE 9B1M





## D<sup>2</sup>Pak Package Outline



**NOTES:**

- 1 DIMENSIONS AFTER SOLDER DIP.
- 2 DIMENSIONING & TOLERANCING PER ANSI Y14.5M, 1982.
- 3 CONTROLLING DIMENSION : INCH.
- 4 HEATSINK & LEAD DIMENSIONS DO NOT INCLUDE BURRS.

**LEAD ASSIGNMENTS**

- 1 - GATE
- 2 - DRAIN
- 3 - SOURCE

## D<sup>2</sup>Pak Part Marking Information



# IRFB/IRFS/IRFSL17N20D



## TO-262 Package Outline

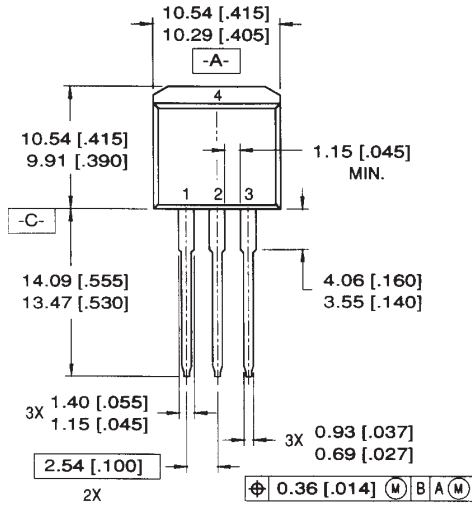

### LEAD ASSIGNMENTS

- |           |            |
|-----------|------------|
| 1 = GATE  | 3 = SOURCE |
| 2 = DRAIN | 4 = DRAIN  |



### NOTES:

1. DIMENSIONING & TOLERANCING PER ANSI Y14.5M-1982
2. CONTROLLING DIMENSION: INCH.
3. DIMENSIONS ARE SHOWN IN MILLIMETERS [INCHES].
4. HEATSINK & LEAD DIMENSIONS DO NOT INCLUDE BURRS.

## TO-262 Part Marking Information

EXAMPLE: THIS IS AN IRL3103L  
 LOT CODE 1789  
 ASSEMBLED ON WW 19, 1997  
 IN THE ASSEMBLY LINE "C"

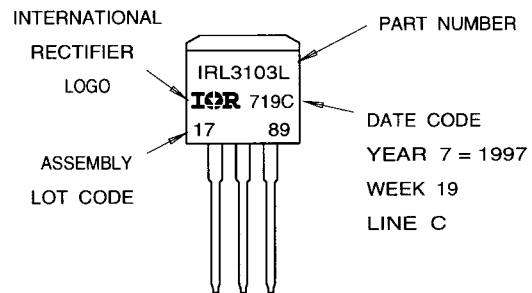

## D<sup>2</sup>Pak Tape & Reel Information

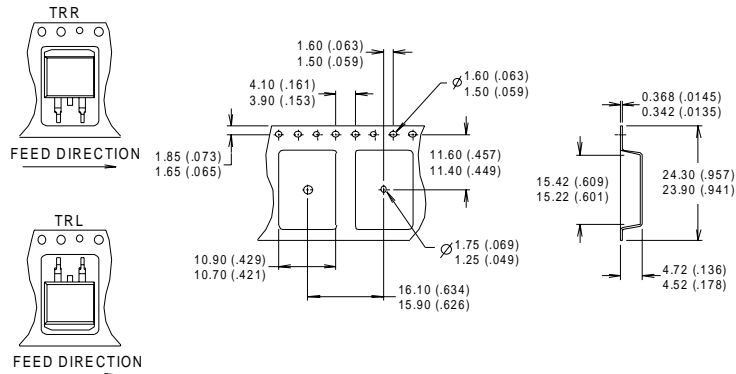

- NOTES :
1. CONFORMS TO EIA-418.
  2. CONTROLLING DIMENSION: MILLIMETER.
  3. DIMENSION MEASURED @ HUB.
  4. INCLUDES FLANGE DISTORTION @ OUTER EDGE.

### Notes:

- ① Repetitive rating; pulse width limited by max. junction temperature.
- ② Starting  $T_J = 25^\circ\text{C}$ ,  $L = 5.0\text{mH}$   
 $R_G = 25\Omega$ ,  $I_{AS} = 9.8\text{A}$ .
- ③  $I_{SD} \leq 9.8\text{A}$ ,  $di/dt \leq 110\text{A}/\mu\text{s}$ ,  $V_{DD} \leq V_{(BR)DSS}$ ,  
 $T_J \leq 175^\circ\text{C}$
- ④ Pulse width  $\leq 300\mu\text{s}$ ; duty cycle  $\leq 2\%$ .
- ⑤  $C_{OSS}$  eff. is a fixed capacitance that gives the same charging time as  $C_{OSS}$  while  $V_{DS}$  is rising from 0 to 80%  $V_{DSS}$
- ⑥ This is only applied to TO-220AB package
- ⑦ This is applied to D<sup>2</sup>Pak, when mounted on 1" square PCB ( FR-4 or G-10 Material ).  
 For recommended footprint and soldering techniques refer to application note #AN-994.