

SHINDENGEN

Super Fast Recovery Rectifiers

Single

SF3L60U

600V 3A

OUTLINE DIMENSIONS

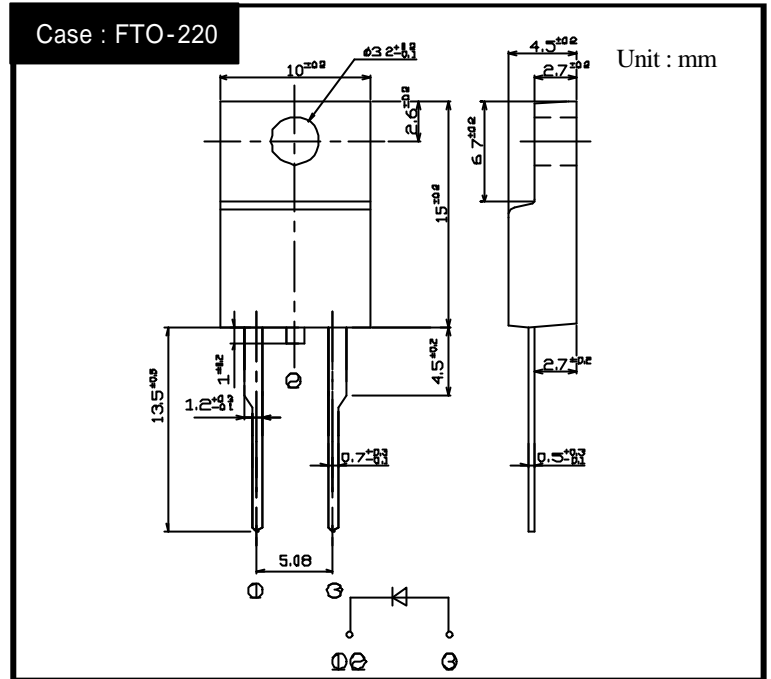

RATINGS

Absolute Maximum Ratings (If not specified Tc=25)

Item	Symbol	Conditions	Ratings	Unit
Storage Temperature	Tstg		-55 ~ 150	
Operating Junction Temperature	Tj		150	
Max Reverse Voltage	V _{RM}		600	V
Average Rectified Forward Current	I _o	50Hz sine wave, resistance load, Tc=115	3	A
Peak Surge Forward Current	I _{FSM}	50Hz sine wave, Non-repetitive 1 cycle peak value, Tj=25	40	A
Dielectric Strength	V _{dis}	Terminals to case, AC 1 minute	2	kV
Mounting Torque	TOR	() Shows recommended value	0.5(0.3)	N·m

Electrical Characteristics (If not specified Tc=25)

Item	Symbol	Conditions	Ratings	Unit
Forward Voltage	V _F	I _F =3A, Pulse measurement	Max.3.0	V
Reverse Current	I _R	V _R =V _{RM} , Pulse measurement	Max.25	μA
Junction Capacitance	C _j	f=1MHz, V _R =10V	Typ.20	pF
Reverse Recovery Time	t _{rr}	I _F =0.5A, I _R =1A	Max.20	ns
Thermal Resistance	θ _c	junction to case with heatsink	Max.3.8	/W

SF3L60U

Forward Voltage

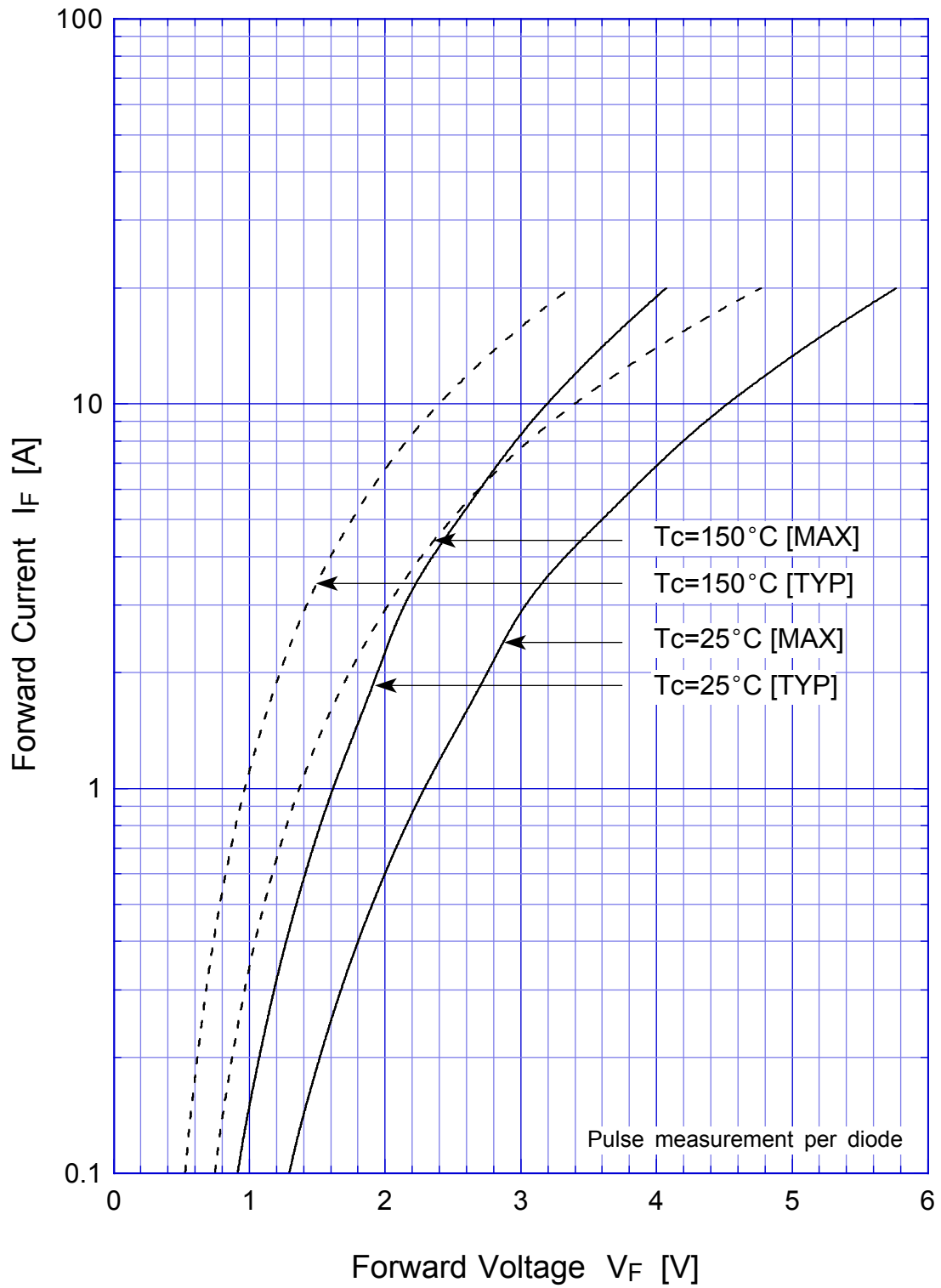

SF3L60U Forward Power Dissipation

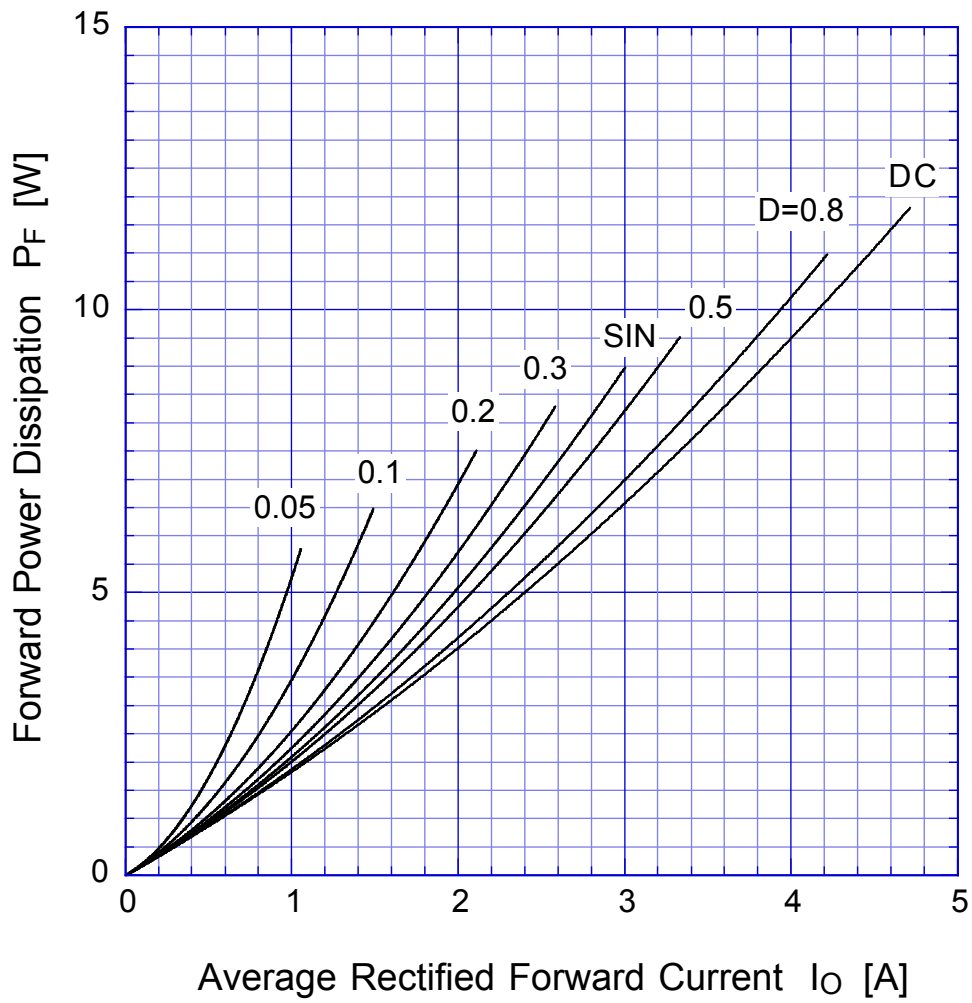

$T_j = 150^\circ\text{C}$

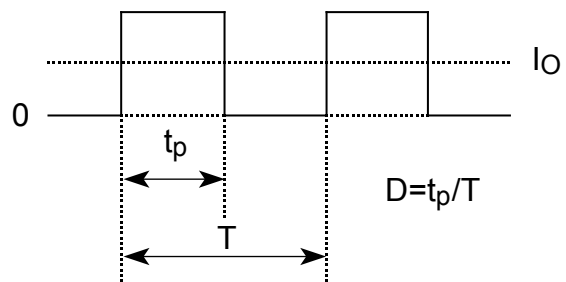

SF3L60U

Derating Curve

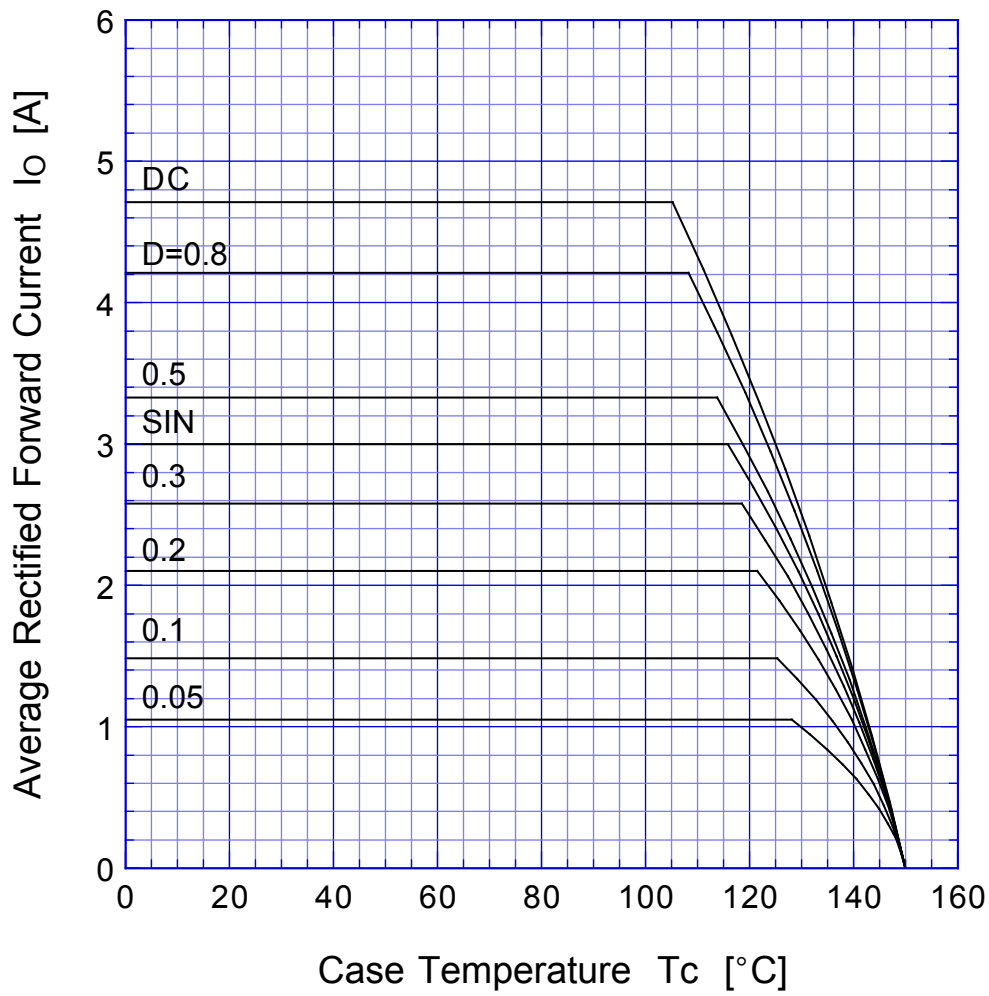

$$V_R = V_{RM}$$

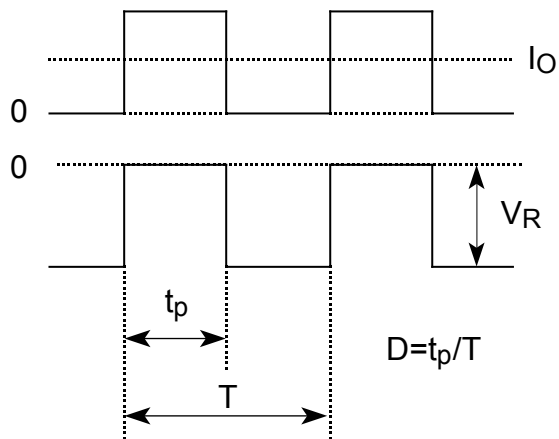

SF3L60U

Peak Surge Forward Capability

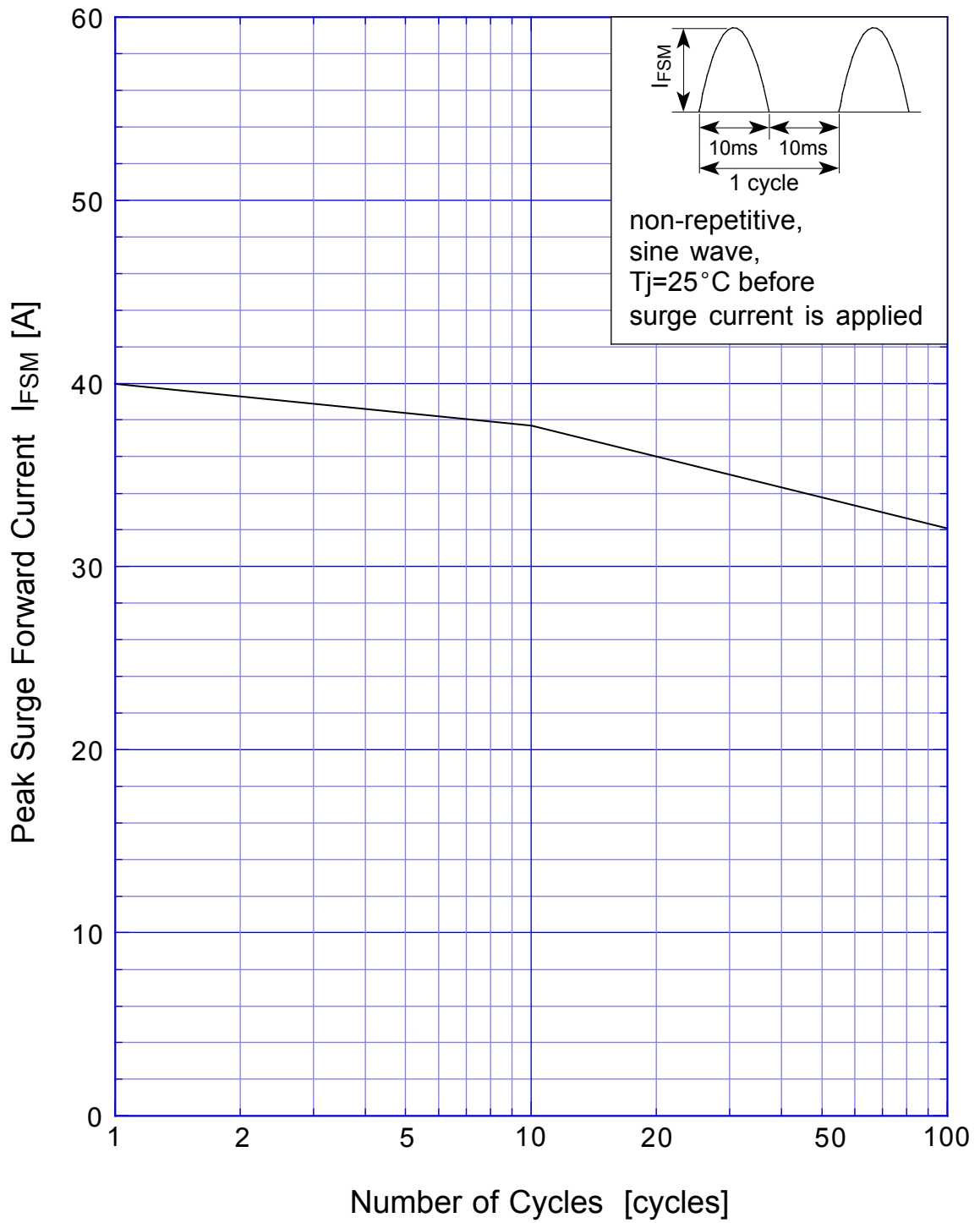

SF3L60U Junction Capacitance

