



### P-Channel 2.5-V (G-S) MOSFET

#### CHARACTERISTICS

- P-Channel Vertical DMOS
- Macro Model (Subcircuit Model)
- Level 3 MOS
- Apply for both Linear and Switching Application
- Accurate over the -55 to 125°C Temperature Range
- Model the Gate Charge, Transient, and Diode Reverse Recovery Characteristics

#### DESCRIPTION

The attached spice model describes the typical electrical characteristics of the p-channel vertical DMOS. The subcircuit model is extracted and optimized over the -55 to 125°C temperature ranges under the pulsed 0-V to 5-V gate drive. The saturated output impedance is best fit at the gate bias near the threshold voltage.

A novel gate-to-drain feedback capacitance network is used to model the gate charge characteristics while avoiding convergence difficulties of the switched  $C_{gd}$  model. All model parameter values are optimized to provide a best fit to the measured electrical data and are not intended as an exact physical interpretation of the device.

#### SUBCIRCUIT MODEL SCHEMATIC

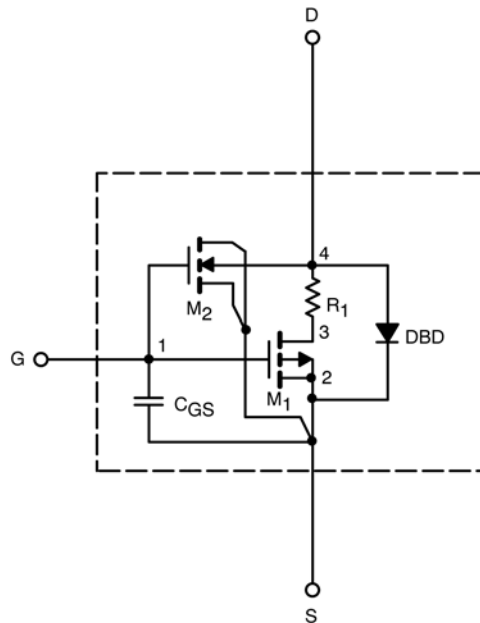

This document is intended as a SPICE modeling guideline and does not constitute a commercial product data sheet. Designers should refer to the appropriate data sheet of the same number for guaranteed specification limits.



SPECIFICATIONS (T <sub>J</sub> = 25°C UNLESS OTHERWISE NOTED)					
Parameter	Symbol	Test Condition	Simulated Data	Measured Data	Unit
<b>Static</b>					
Gate Threshold Voltage	V <sub>GS(th)</sub>	V <sub>DS</sub> = V <sub>GS</sub> , I <sub>D</sub> = -250 μA	0.82		V
On-State Drain Current <sup>a</sup>	I <sub>D(on)</sub>	V <sub>DS</sub> = -5 V, V <sub>GS</sub> = -4.5 V	25		A
Drain-Source On-State Resistance <sup>a</sup>	r <sub>DS(on)</sub>	V <sub>GS</sub> = -4.5 V, I <sub>D</sub> = -0.87 A	0.136	0.140	Ω
		V <sub>GS</sub> = -2.5 V, I <sub>D</sub> = -0.75 A	0.187	0.180	
		V <sub>GS</sub> = -1.8 V, I <sub>D</sub> = -0.20 A	0.255	0.230	
Forward Transconductance <sup>a</sup>	g <sub>fs</sub>	V <sub>DS</sub> = -10 V, I <sub>D</sub> = -0.87 A	3.5	3.5	S
Diode Forward Voltage <sup>a</sup>	V <sub>SD</sub>	I <sub>S</sub> = -0.14 A, V <sub>GS</sub> = 0 V	-0.74	-0.78	V
<b>Dynamic<sup>b</sup></b>					
Total Gate Charge	Q <sub>g</sub>	V <sub>DS</sub> = -6 V, V <sub>GS</sub> = -4.5 V, I <sub>D</sub> = -0.87 A	3.7	3.8	nC
Gate-Source Charge	Q <sub>gs</sub>		0.70	0.70	
Gate-Drain Charge	Q <sub>gd</sub>		0.80	0.80	
Turn-On Delay Time	t <sub>d(on)</sub>	V <sub>DD</sub> = -6 V, R <sub>L</sub> = 12 Ω I <sub>D</sub> ≅ -0.50 A, V <sub>GEN</sub> = -4.5 V, R <sub>G</sub> = 6 Ω	12	15	ns
Rise Time	t <sub>r</sub>		18	20	
Turn-Off Delay Time	t <sub>d(off)</sub>		30	30	
Fall Time	t <sub>f</sub>		37	16	
Source-Drain Reverse Recovery Time	t <sub>rr</sub>	I <sub>F</sub> = -0.14 A, di/dt = 100 A/μs	21	20	

**Notes**

- a. Pulse test; pulse width ≤ 300 μs, duty cycle ≤ 2%.
- b. Guaranteed by design, not subject to production testing.



# SPICE Device Model Si1039X

## Vishay Siliconix

COMPARISON OF MODEL WITH MEASURED DATA ( $T_J=25^\circ\text{C}$  UNLESS OTHERWISE NOTED)

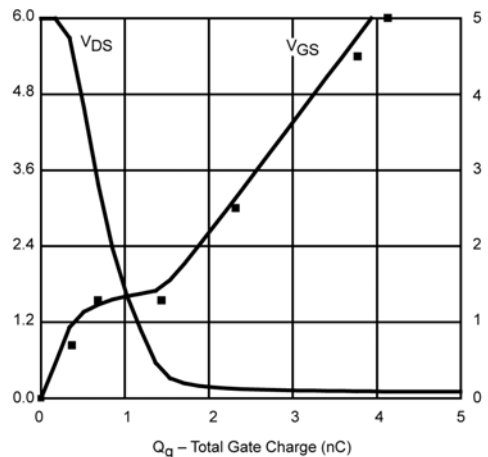
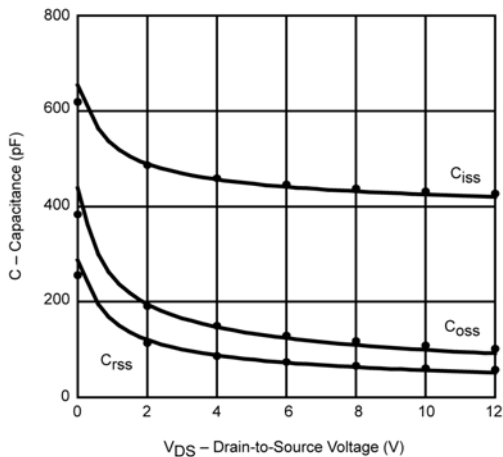
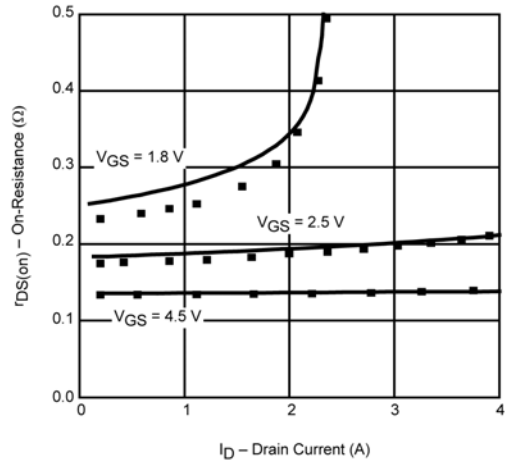
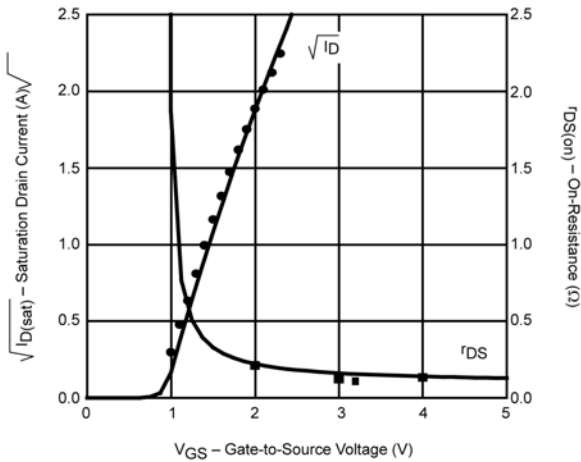
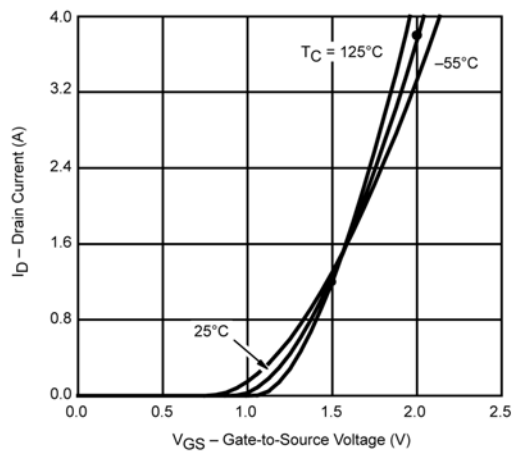
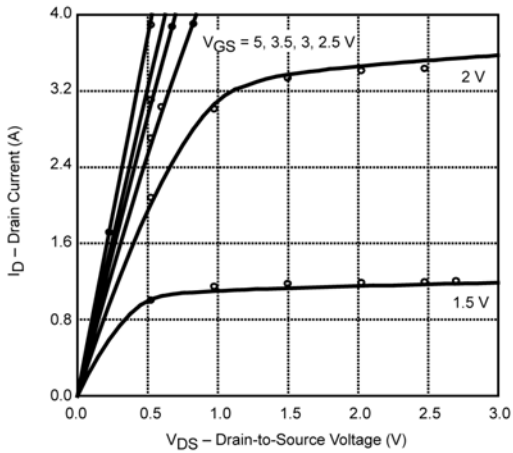

Note: Dots and squares represent measured data.