

## FAST RECOVERY RECTIFIER DIODES

### FEATURES

- HIGH VOLTAGE CAPABILITY
- FAST AND SOFT RECOVERY
- INSULATED PACKAGE :  
insulating voltage = 2000V<sub>DC</sub>  
capacitance = 12 pF

### DESCRIPTION

Single chip rectifier suited for power conversion and polarity protection applications.  
This device is packaged in TO220AC and in ISOWATT220AC.

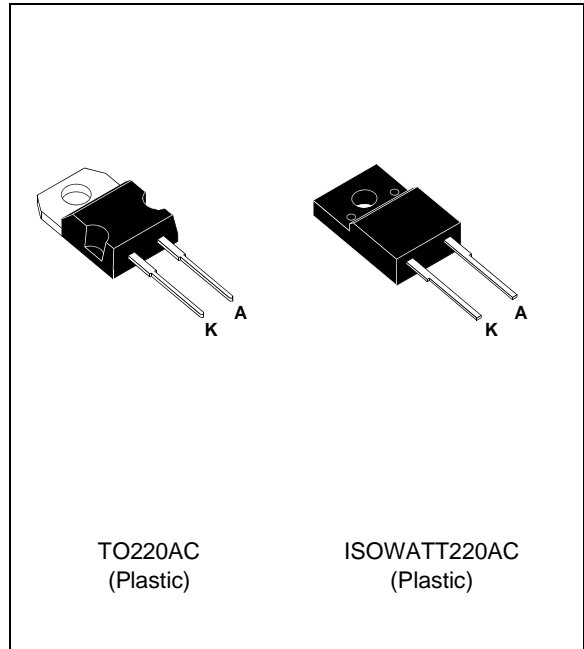

### ABSOLUTE MAXIMUM RATINGS

Symbol	Parameter		Value	Unit	
I <sub>F(RMS)</sub>	RMS on-state current		12	A	
I <sub>F(AV)</sub>	Average forward current $\delta = 0.5$	TO220AC	T <sub>c</sub> =130°C	6	A
		ISOWATT220AC	T <sub>c</sub> =105°C	6	
I <sub>FSM</sub>	Surge non repetitive forward current		tp=10ms sinusoidal	90	A
T <sub>stg</sub> T <sub>j</sub>	Storage and junction temperature range		- 65 to + 150 - 65 to + 150	°C °C	

Symbol	Parameter	BYT71-(F)		Unit
		600	800	
V <sub>R</sub> RM	Repetitive peak off-state voltage	600	800	V

**THERMAL RESISTANCES**

Symbol	Parameter		Value	Unit
Rth (j-c)	Junction to case	TO220AC	2.3	°C/W
		ISOWATT220AC	4.9	

**ELECTRICAL CHARACTERISTICS**
**STATIC CHARACTERISTICS**

Symbol	Test Conditions		Min.	Typ.	Max.	Unit
I <sub>R</sub> **	T <sub>j</sub> = 25°C	V <sub>R</sub> = V <sub>R</sub> RM			20	μA
	T <sub>j</sub> = 100°C				1	mA
V <sub>F</sub> *	T <sub>j</sub> = 100°C	I <sub>F</sub> = 6 A			1.3	V
	T <sub>j</sub> = 25°C	I <sub>F</sub> = 6 A			1.4	

Pulse test : \* tp = 380 μs, duty cycle < 2 %

\*\* tp = 5 ms, duty cycle < 2 %

**RECOVERY CHARACTERISTICS**

Symbol	Test Conditions		Min.	Typ.	Max.	Unit
trr	T <sub>j</sub> = 25°C	I <sub>F</sub> = 1A V <sub>R</sub> = 30V dI <sub>F</sub> /dt = -15A/μs			300	ns

To evaluate the conduction losses use the following equations :

$$P = 1.15 \times I_F(AV) + 0.025 \times I_F^2(RMS)$$

**Fig.1 :** Average forward power dissipation versus average forward current.

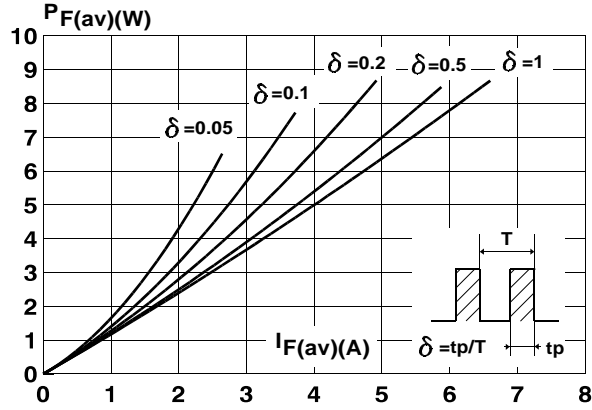

**Fig.2 :** Peak current versus form factor.

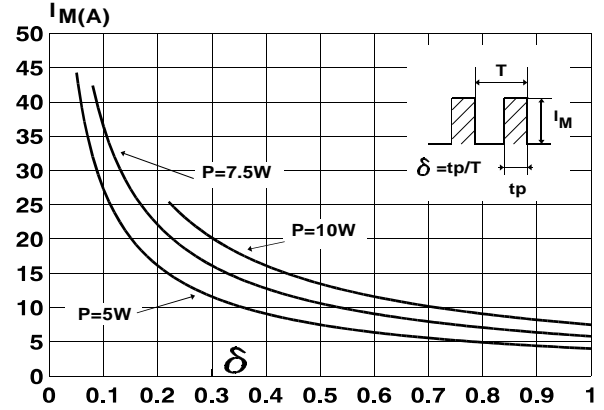

**Fig.3 :** Forward voltage drop versus forward current (maximum values).

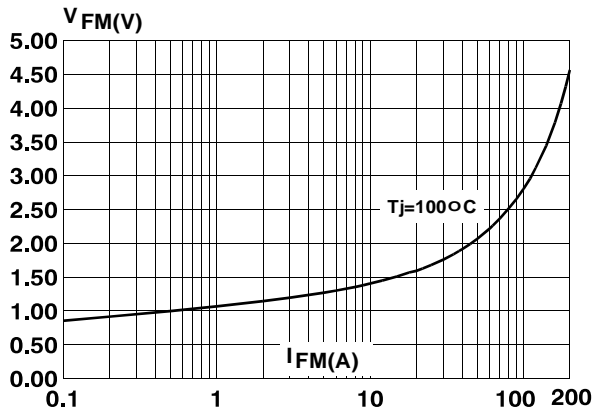

**Fig.4 :** Relative variation of thermal impedance junction to case versus pulse duration. (TO 220 AC)

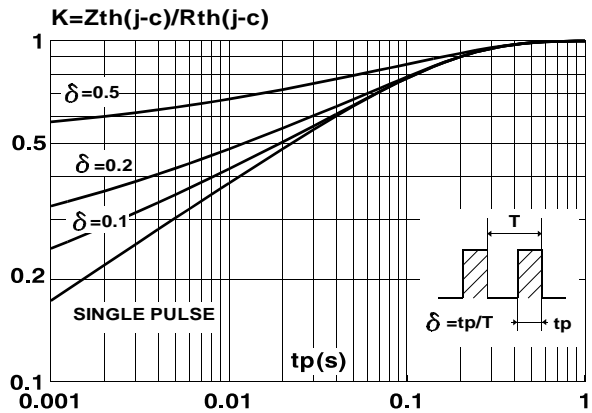

**Fig.5 :** Relative variation of thermal impedance junction to case versus pulse duration. (ISOWATT220AC)

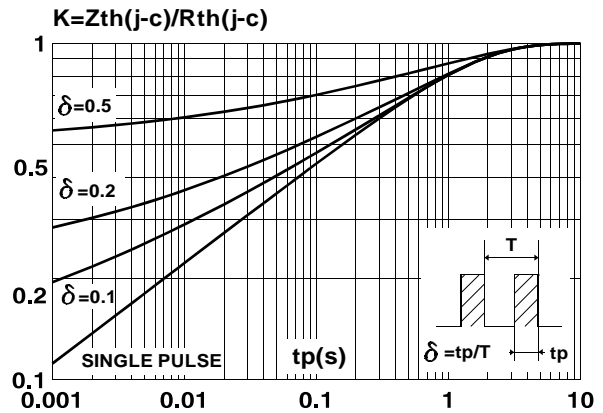

**Fig.6 :** Non repetitive surge peak forward current versus overload duration. (TO 220 AB)

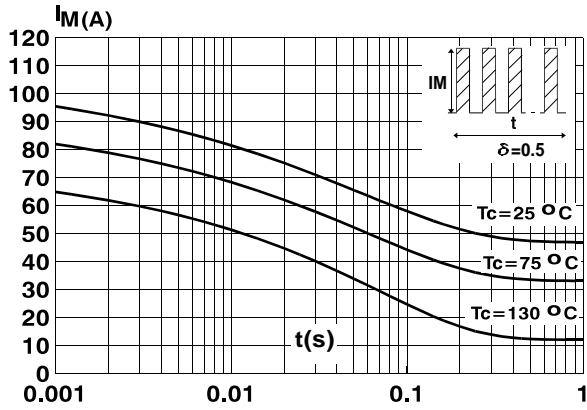

**Fig.7 :** Non repetitive surge peak forward current versus overload duration. (ISOWATT220AB)

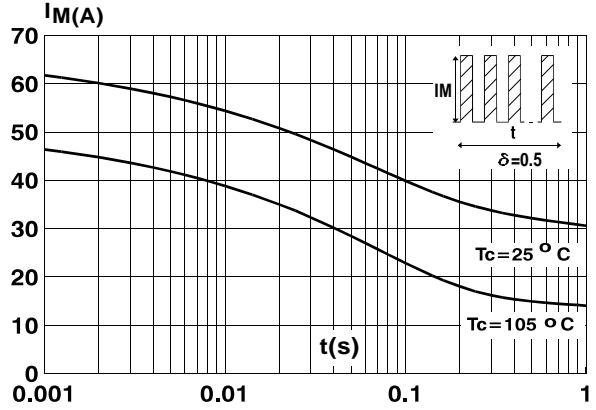

**Fig.8 :** Average current versus ambient temperature. (duty cycle : 0.5) (TO 220 AB)

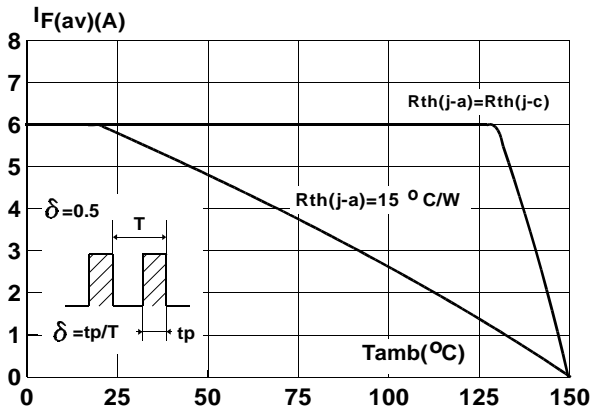

**Fig.9 :** Average current versus ambient temperature. (duty cycle : 0.5) (ISOWATT220AB)

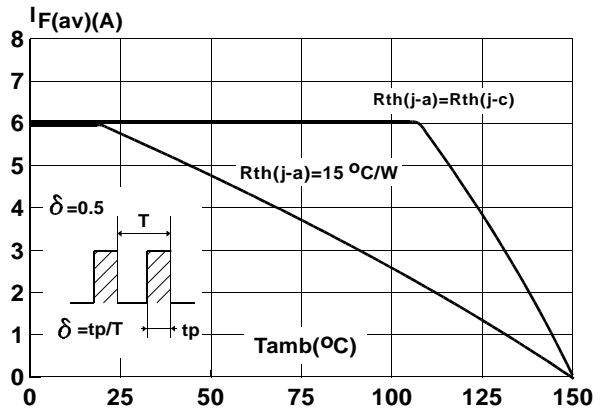

**Fig.10 :** Junction capacitance versus reverse voltage applied (Typical values).

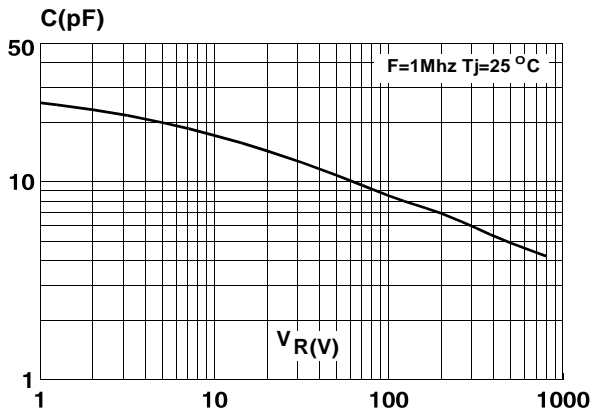

**Fig.11 :** Recovery charges versus dIF/dt.

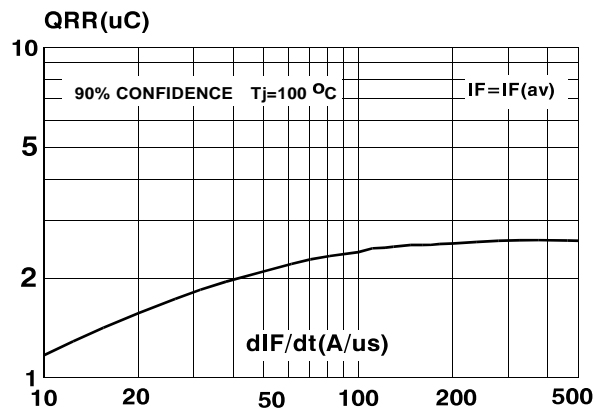

Fig.12 : Peak reverse current versus dIF/dt.

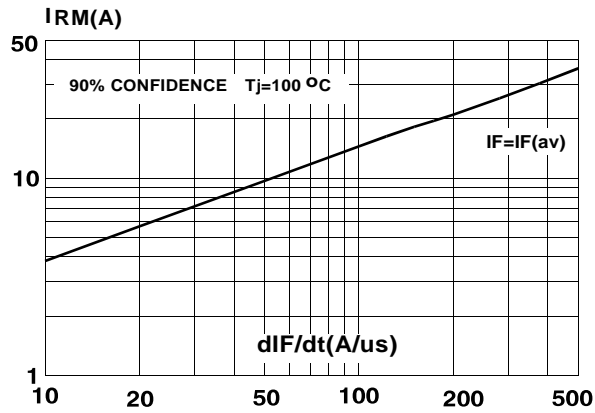

Fig.14 : Peak forward voltage versus dIF/dt.

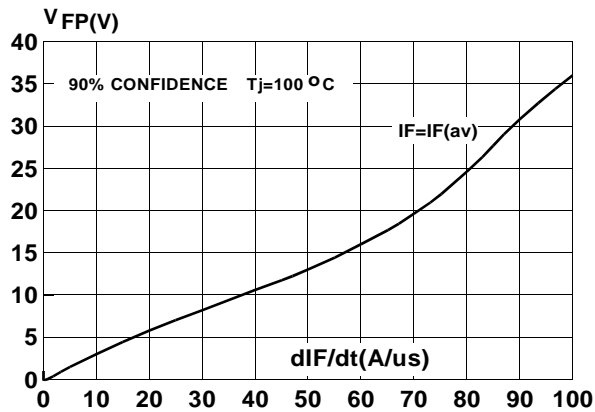

Fig.13 : Dynamic parameters versus junction temperature.

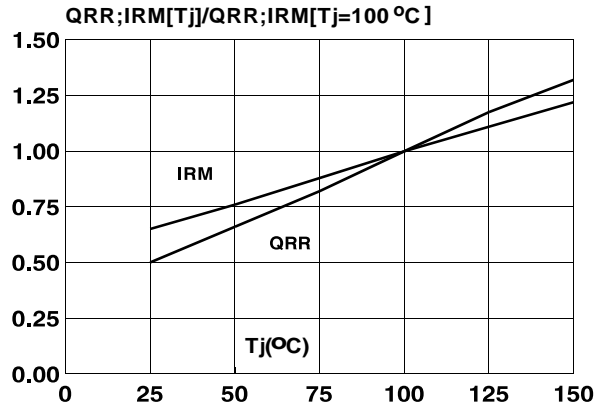
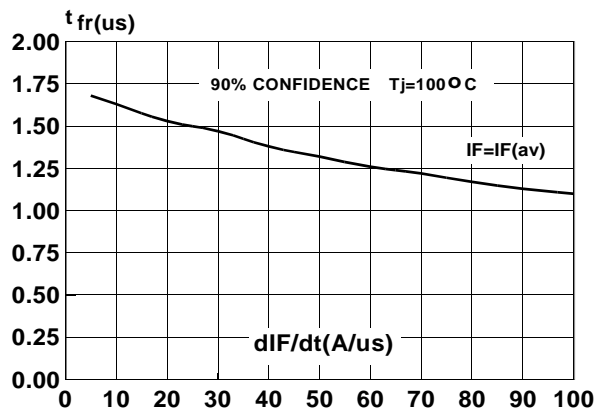
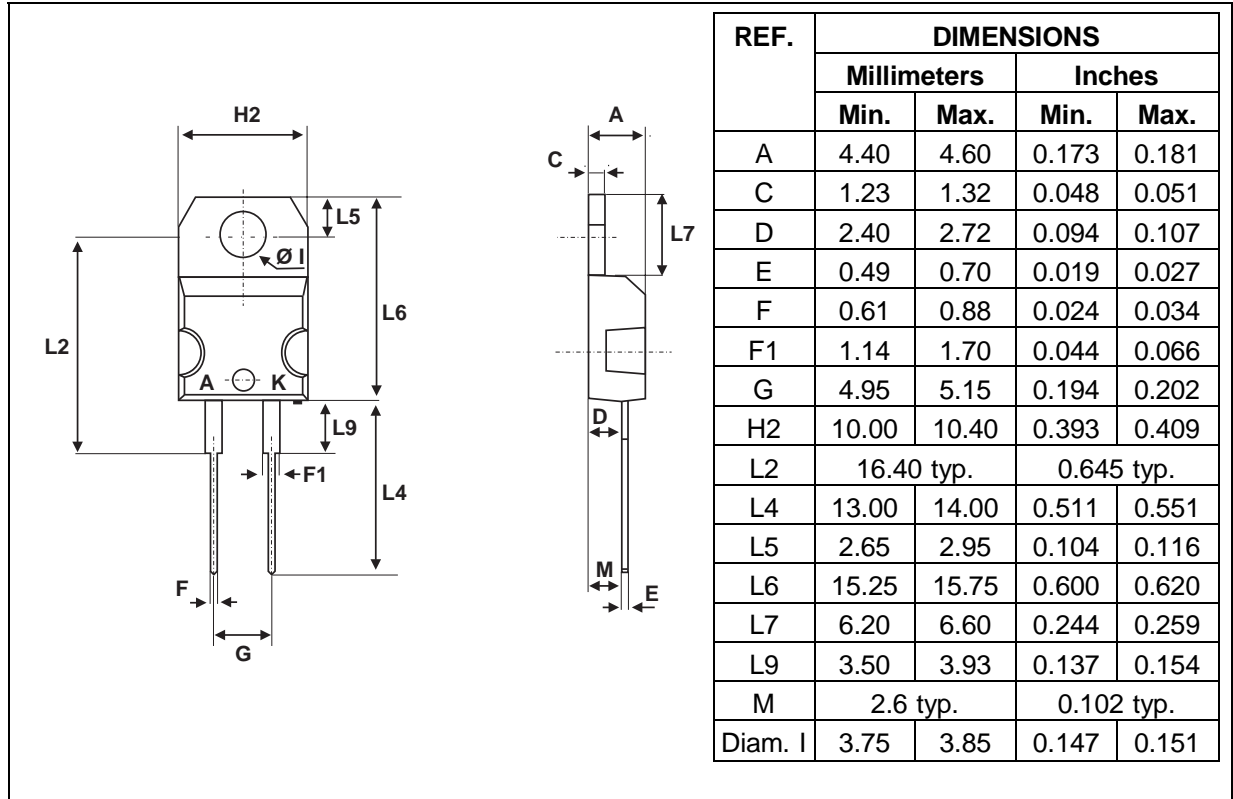

Fig.15 : Recovery time versus dIF/dt.



PACKAGE MECHANICAL DATA

TO220 AC Plastic



- **Marking** : Type number
- **Cooling method** : C
- **Weight** : 1.86 g
- **Recommended torque value** : 0.55m.N
- **Maximum torque value** : 0.70m.N

## PACKAGE MECHANICAL DATA

ISOWATT220AC Plastic

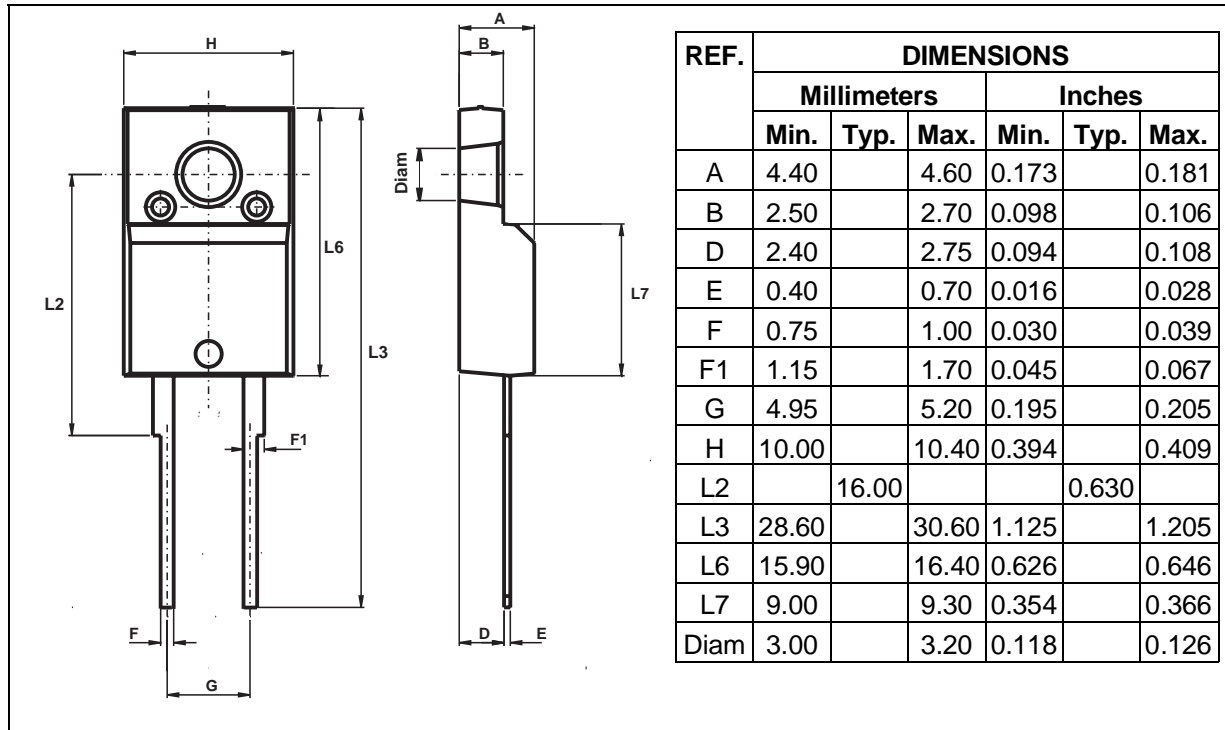

- **Marking** : Type number
- **Cooling method** : C
- **Weight** : 2 g
- **Recommended torque value** : 0.55m.N
- **Maximum torque value** : 0.70m.N

Information furnished is believed to be accurate and reliable. However, STMicroelectronics assumes no responsibility for the consequences of use of such information nor for any infringement of patents or other rights of third parties which may result from its use. No license is granted by implication or otherwise under any patent or patent rights of STMicroelectronics. Specifications mentioned in this publication are subject to change without notice. This publication supersedes and replaces all information previously supplied.

STMicroelectronics products are not authorized for use as critical components in life support devices or systems without express written approval of STMicroelectronics.

The ST logo is a registered trademark of STMicroelectronics

© 1998 STMicroelectronics - Printed in Italy - All rights reserved.

STMicroelectronics GROUP OF COMPANIES

Australia - Brazil - Canada - China - France - Germany - Italy - Japan - Korea - Malaysia - Malta - Mexico - Morocco - The Netherlands - Singapore - Spain - Sweden - Switzerland - Taiwan - Thailand - United Kingdom - U.S.A.