

HIGH EFFICIENCY RED FND310C FND317C FND318C

PACKAGE DIMENSIONS

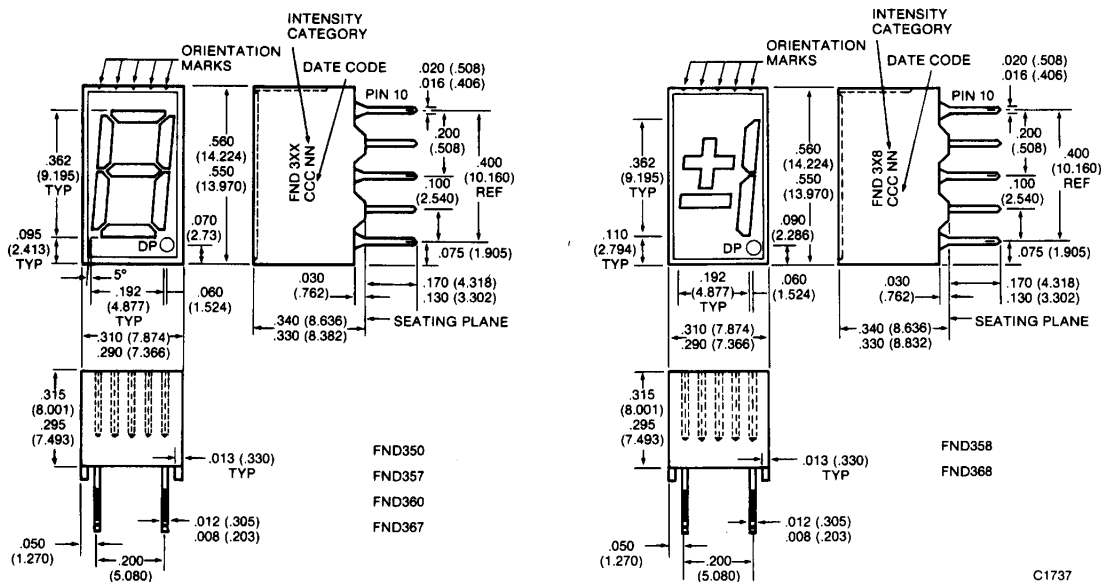

- NOTES:
1. ALL DIMENSIONS ARE IN MM (INCH)
2. TOLERANCE ARE ± 0.010 INCH UNLESS OTHERWISE SPECIFIED

DESCRIPTION

The FND310C, FND317C and FND318D are high efficiency red GaP 7-segment displays with nominal 0.362" digit height. Reflector cap, PCB and encapsulant are used in the construction of these FND3XXCs.

FEATURES

- Exactly pin and package compatible with FND3XX
- Compact — 10 digits in 3-inch panel width
- Wide viewing angle
- Right-hand decimal configuration
- Categorized for luminous intensity
- Rugged encapsulated plastic construction

MODEL NUMBERS

PART NUMBER	COLOR	DESCRIPTION
FND310C	Hi. Eff. Red	Common anode seven segment display
FND317C	Hi. Eff. Red	Common cathode seven segment display
FND318C	Hi. Eff. Red	Common cathode ± 1 overflow display

ABSOLUTE MAXIMUM RATINGS		
	FND310C/317C	FND318C
Power dissipation at 25°C ambient	500 mW	320 mW
Continuous forward current		
Total	200 mA	125 mA
Per segment or decimal point	25 mA	25 mA
Reverse voltage		
Per segment or decimal point	6 V	6 V
Storage and operating temperature	-25°C to +85°C	-25°C to +85°C
Soldering time at 250°C (1/16 inch from the seating plane) ...	3 sec	3 sec

ELECTRO-OPTICAL CHARACTERISTICS (TA=25°C Unless Otherwise Specified)					
PARAMETER	MIN.	TYP.	MAX.	UNIT	TEST CONDITIONS
Forward voltage - V (per diode)		2.0	2.5	V	I _f =20 mA
Luminous intensity - I _v	1800	2700		μcd	I _f =20 mA
Peak wavelength		655		nm	I _f =20 mA
Spectrum radiation bandwidth		45		nm	I _f =20 mA
Reverse voltage-V _r	5			V	I _r =100 μA
Capacitance - C		35		pF	V=0, F=1 MHz

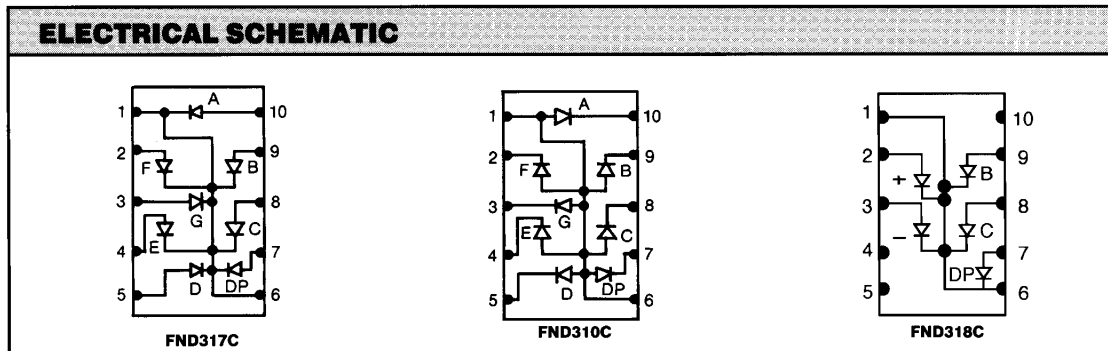
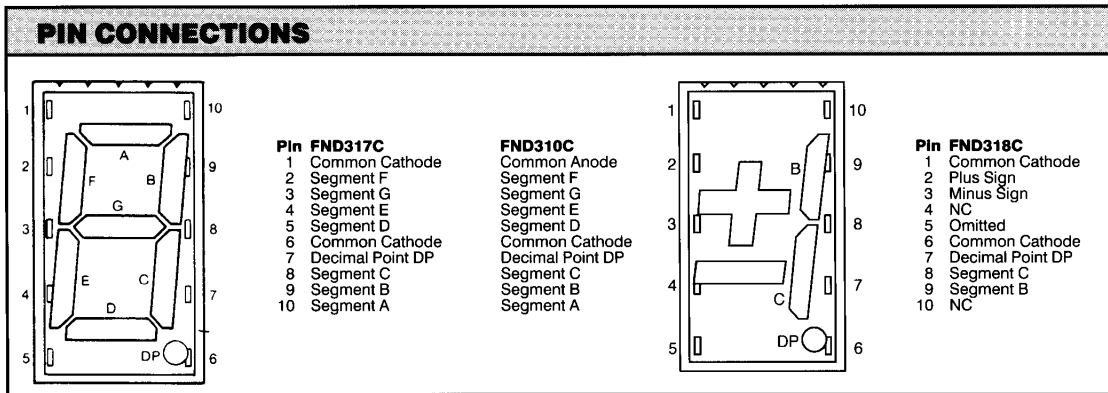

TYPICAL ELECTRO - OPTICAL CHARACTERISTIC CURVES

($T_A = 25^\circ\text{C}$ Unless otherwise specified)

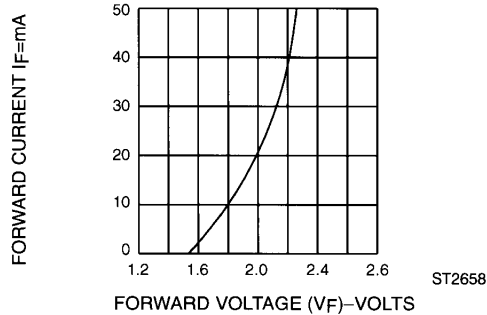

Fig. 1 Forward Current vs. Forward Voltage

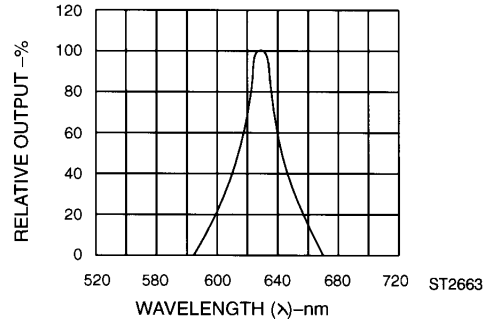

Fig. 2. Spectral Response

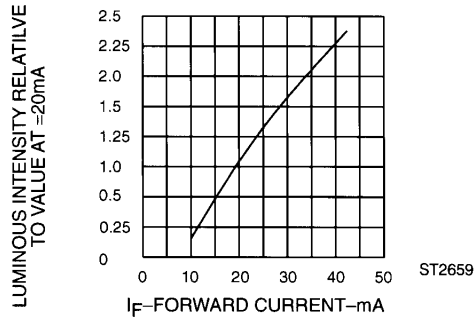

Fig. 3 Relative Luminous Intensity vs. Forward Current

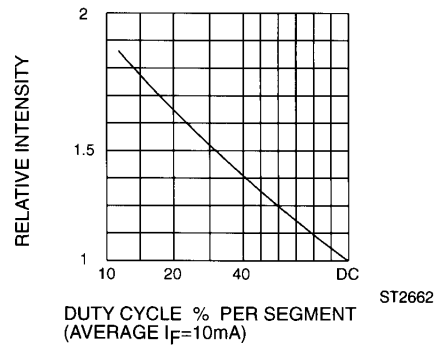

Fig. 5 Luminous Intensity vs. Duty Cycle

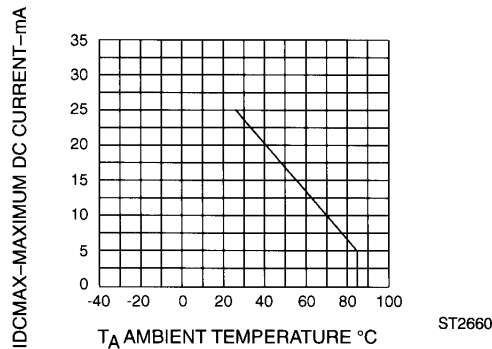

Fig. 4 Maximum Allowable DC Current Per Segment vs. a Function of Ambient Temperature

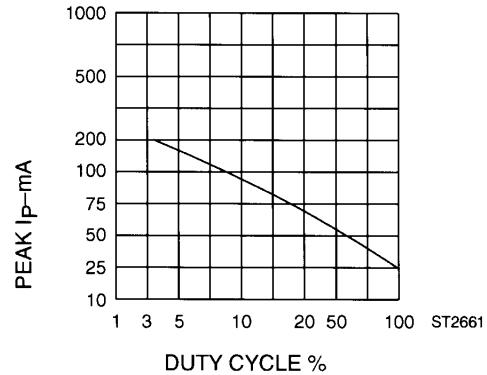

Fig. 6 Max Peak Current vs. Duty Cycle % (Refresh Rate $f = 1\text{KHz}$)

Clean the displays only in water, isopropanol, ethanol, freon TF or TE (or equivalent)



0.362-INCH 7-SEGMENT DISPLAY

DISCLAIMER

FAIRCHILD SEMICONDUCTOR RESERVES THE RIGHT TO MAKE CHANGES WITHOUT FURTHER NOTICE TO ANY PRODUCTS HEREIN TO IMPROVE RELIABILITY, FUNCTION OR DESIGN. FAIRCHILD DOES NOT ASSUME ANY LIABILITY ARISING OUT OF THE APPLICATION OR USE OF ANY PRODUCT OR CIRCUIT DESCRIBED HEREIN; NEITHER DOES IT CONVEY ANY LICENSE UNDER ITS PATENT RIGHTS, NOR THE RIGHTS OF OTHERS.

LIFE SUPPORT POLICY

FAIRCHILD'S PRODUCTS ARE NOT AUTHORIZED FOR USE AS CRITICAL COMPONENTS IN LIFE SUPPORT DEVICES OR SYSTEMS WITHOUT THE EXPRESS WRITTEN APPROVAL OF THE PRESIDENT OF FAIRCHILD SEMICONDUCTOR CORPORATION. As used herein:

1. Life support devices or systems are devices or systems which, (a) are intended for surgical implant into the body, or (b) support or sustain life, and (c) whose failure to perform when properly used in accordance with instructions for use provided in the labeling, can be reasonably expected to result in a significant injury of the user.
2. A critical component in any component of a life support device or system whose failure to perform can be reasonably expected to cause the failure of the life support device or system, or to affect its safety or effectiveness.