

Ceramic Disc Capacitors for Safety Regulations

Type: NS-A

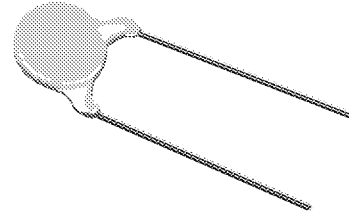

■ Features

- Type NS-A, a revised type designation from our previous type designation of NS for “Class II equipment,” is recognized and classified as Sub-Class Y1 Capacitor according to IEC384-14 2nd Edition by European Safety Regulations.
- The Type NS-A is recognized by UL and CSA (UL 1414/250 VAC and CSA C22.2 No. 1).
- The Type NS-A can bridge a “reinforced insulation” by a single capacitor in Class II equipment/apparatus of EN60065.

■ Explanation of Part Numbers

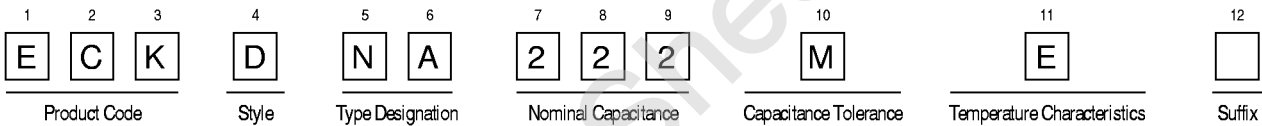

Note: Suffix “NA” in the part number indicates type “NS-A”.

■ Specifications

Operating temperature range	-25 to 85°C		
Rated voltage	Applicable standard		Rated voltage
	UL		250 VAC
	CSA		125 VAC
	IEC 384-14 2nd. Ed. (EN 132 400) Sub-Class Y1		250 VAC
	SEV1016 (3300 to 4700 pF)		250 VAC
	BSI (BS415: 1990), VDE 560-2, SEV1016 (100 to 2200 pF)		400 VAC
Dielectric withstanding voltage	4000 VAC (50/60 Hz) for 1 minute		
Capacitance	Within the tolerance, when measured at 1 kHz ± 20%, 1 Vrms and 20°C		
Dissipation factor (tan δ)	0.025 max., when measured at 1 kHz ± 20%, 1 Vrms and 20°C		
Insulation resistance	10,000 MΩ min. at 500 VDC and 1 minute electrification		
Temperature characteristics (Reference temperature: 20°C)	T. C.	Capacitance Change	Temperature Range
	B/Y5P/2B4	±10% max.	-25 to 85°C
	E/Y5U/2E4	±20/-55% max.	-25 to 85°C

■ Related Standards and Certificate Numbers (Type NS-A)

Related Standard	Certificate No.	Sub-Class	Rated Voltage	Dielectric Withstanding Voltage	Applicable Temp. Char.	
					B	V
BSI (UK)	BS415: 1994	Y1	250 VAC	4000 VAC	●	●
	BS 415: 1990*	—	400 VAC	2000 VAC	●	●
VDE (Germany)	EN132 400: 1994	Y1	250 VAC	4000 VAC	●	
		Y1	250 VAC	4000 VAC		●
	VDE 560-2*: 1970	—	400 VAC	2500 VAC	●	
		—	400 VAC	2500 VAC		●
SEV (Switzerland)	EN 132 400: 1994	Y1	250 VAC	4000 VAC	●	●
	SEV 1016* ① :1959	—	400 VAC	4000 VAC	●	● †
		—	250 VAC	4000 VAC		● ††
SEMKO (Sweden)	EN 132 400: 1994	Y1	250 VAC	4000 VAC	●	●
FIMKO (Finland)	EN 132 400: 1994	Y1	250 VAC	4000 VAC	●	●
NEMKO (Norway)	EN 132 400: 1994	Y1	250 VAC	4000 VAC	●	●
DEMKO (Denmark)	EN 132 400: 1994	Y1	250 VAC	4000 VAC	●	●
UL (USA)	UL1414	—	250 VAC	1500 VAC	●	●
CSA (Canada)	CSA C22.2 No. 1	—	125 VAC	1250 VAC	●	●

* Type NS-A capacitor covers the previous recognitions of related safety standards with *.

† 1500 pF, 2200 pF
†† 3300 pF, 4700 pF









■ Marking

Marking Items

Manufacturer's identification	
Type designation	NS-A
Sub-class and rated voltage according to EN132400	Y1-250V~

Rated Capacitance
Plant code
Date code

Recognized Marking (Logo or monogram)

VDE 	NEMKO 
SEV 	DEMKO 
SEMKO 	UL 
FIMKO 	CSA 

Examples

EECKDNB472ME as an example

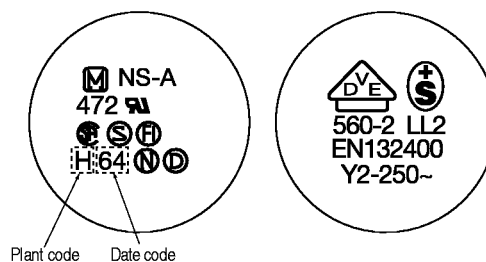

■ Dimensions in mm (not to scale)

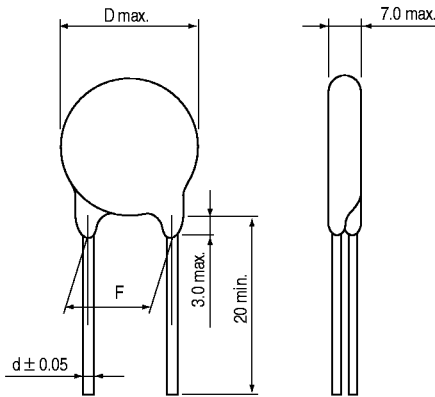

■ Typical Temperature Characteristics

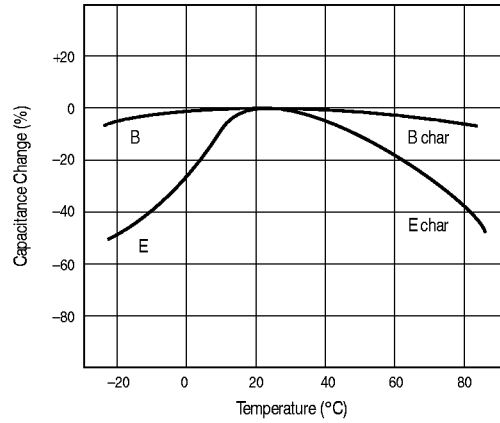

■ Ratings and Characteristics

Part Number	Capacitance		Temperature Characteristics	Dimensions in mm		
	Nominal Capacitance (pF)	Tolerance (%)		D max.	F	d
ECKDNA101 □ B	100	±10 or ±20	B/Y5P/2B4	11.0	10.0 ^{+1.5} _{-1.0}	0.65
ECKDNA221 □ B	220	±10 or ±20	B/Y5P/2B4	11.0	10.0 ^{+1.5} _{-1.0}	0.65
ECKDNA331 □ B	330	±10 or ±20	B/Y5P/2B4	11.0	10.0 ^{+1.5} _{-1.0}	0.65
ECKDNA471 □ B	470	±10 or ±20	B/Y5P/2B4	11.0	10.0 ^{+1.5} _{-1.0}	0.65
ECKDNA102 □ B	1000	±10 or ±20	B/Y5P/2B4	11.0	10.0 ^{+1.5} _{-1.0}	0.65
ECKDNA152 □ B	1500	±20	E/Y5U/2E4	11.0	10.0 ^{+1.5} _{-1.0}	0.65
ECKDNA222 □ B	2200	±20	E/Y5U/2E4	11.0	10.0 ^{+1.5} _{-1.0}	0.65
ECKDNA332 □ B	3300	±20	E/Y5U/2E4	13.0	10.0 ^{+1.5} _{-1.0}	0.65
ECKDNA472 □ B	4700	±20	E/Y5U/2E4	16.0	10.0 ^{+1.5} _{-1.0}	0.65

* □ Capacitance tolerance code, "K" for ±10% or "M" for ±20%

** Suffix "Y" indicates that the capacitors are recognized and classified as Sub-Class Y2 and X1 capacitors according to IEC384-14 2nd Ed. by European Safety Regulations.

Ceramic Disc Capacitors for Safety Regulations

Type: NS-B

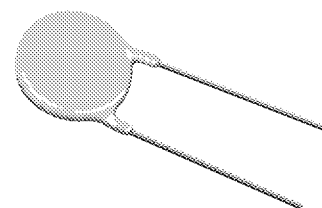

■ Features

- Type NS-B, a revised type designation from our previous type designation of NS for “Class I Equipment,” is recognized and classified as Sub-Class Y2 capacitor according to IEC384-14 2nd Ed. by European Safety Regulations.
- The Type NS-B is recognized by UL and CSA (UL1414/250 VAC and CSA C22.2 No.1).

■ Explanation of Part Numbers

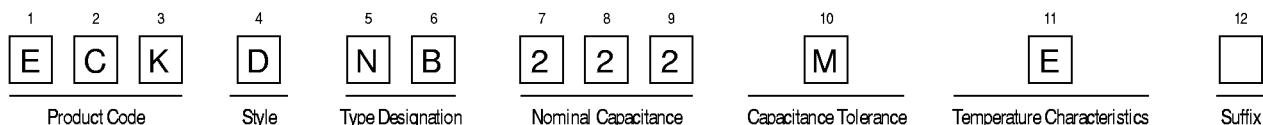

Note: Suffix "NB" in the part number indicates type "NS-B".

■ Specifications

Operating temperature range	-25 to 85°C		
Rated voltage	Applicable standard		Rated voltage
	UL		250 VAC
	CSA		125 VAC
	IEC 384-14 2nd. Ed. (EN 132 400) Sub-Class Y1		250 VAC
	SEV1016 (3300 to 4700 pF)		250 VAC
	BSI (BS415: 1990), VDE 560-2, SEV1016 (100 to 2200 pF)		400 VAC
Dielectric withstanding voltage	2600 VAC (50/60 Hz) for 1 minute		
Capacitance	Within the tolerance, when measured at 1 kHz ± 20%, 1 Vrms and 20°C		
Dissipation factor (tan δ)	0.025 max., when measured at 1 kHz ± 20%, 1 Vrms and 20°C		
Insulation resistance	10,000 MΩ min. at 500 VDC and 1 minute electrification		
Temperature characteristics (Reference temperature: 20°C)	T. C.	Capacitance Change	Temperature Range
	B/Y5P/2B4	±10% max.	-25 to 85°C
	E/Y5U/2E4	±20/-55% max.	-25 to 85°C

■ Related Standards and Certificate Numbers (Type NS-A)

Related Standard	Certificate No.	Sub-Class	Rated Voltage	Dielectric Withstanding Voltage	Applicable Temp. Char.	
					B	V
BSI (UK)	BS415: 1994	Y2	250 VAC	1500 VAC	●	●
	BS 415: 1990*	—	400 VAC	2000 VAC	●	●
VDE (Germany)	EN132 400: 1994	Y2	250 VAC	1500 VAC	●	
		Y2	250 VAC	1500 VAC		●
	VDE 560-2*: 1970	—	400 VAC	2500 VAC	●	
		—	400 VAC	2500 VAC		●
SEV (Switzerland)	EN 132 400: 1994	Y2	250 VAC	1500 VAC	●	●
	SEV 1016* ④ :1959	—	400 VAC	2600 VAC	●	● †
		—	250 VAC	2600 VAC		● ††
SEMKO (Sweden)	EN 132 400: 1994	Y2	250 VAC	1500 VAC	●	●
FIMKO (Finland)	EN 132 400: 1994	Y2	250 VAC	1500 VAC	●	●
NEMKO (Norway)	EN 132 400: 1994	Y2	250 VAC	1500 VAC	●	●
DEMKO (Denmark)	EN 132 400: 1994	Y2	250 VAC	1500 VAC	●	●
UL (USA)	UL1414	—	250 VAC	1500 VAC	●	●
CSA (Canada)	CSA C22.2 No. 1	—	125 VAC	1250 VAC	●	●

* Type NS-B capacitor covers the previous recognitions of related safety standards with *.

† 1500 pF, 2200 pF
†† 3300 pF, 4700 pF









■ Marking

Marking Items

Manufacturer's identification	
Type designation	NS-B
Sub-class and rated voltage according to EN132400	Y1-250V~

Rated Capacitance
Plant code
Date code

Recognized Marking (Logo or monogram)

VDE  560-2 EN132400	NEMKO 
SEV  LL2	DEMKO 
SEMKO 	UL 
FIMKO 	CSA 

Examples

EECKDNB472ME as an example

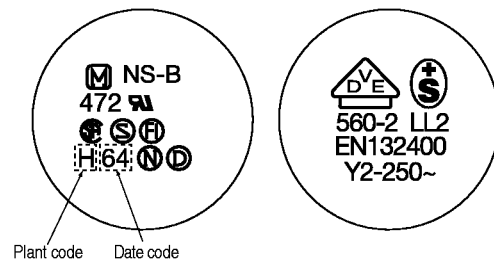

■ Dimensions in mm (not to scale)

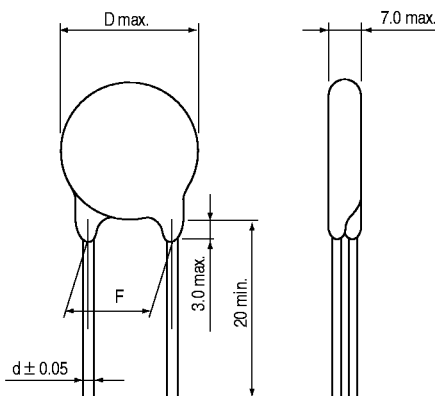

■ Typical Temperature Characteristics

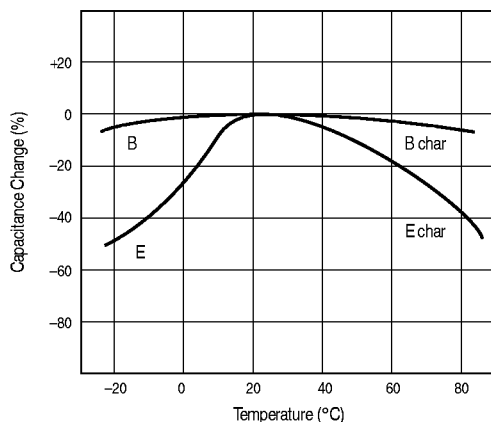

■ Ratings and Characteristics

Part Number	Capacitance		Temperature Characteristics	Dimensions in mm		
	Nominal Capacitance (pF)	Tolerance (%)		D max.	F	d
ECKDNB101 □ B	100	±10 or ±20	B/Y5P/2B4	10.5	7.5	0.65
ECKDNB221 □ B	220	±10 or ±20	B/Y5P/2B4	10.5	7.5	0.65
ECKDNB331 □ B	330	±10 or ±20	B/Y5P/2B4	10.5	7.5	0.65
ECKDNB471 □ B	470	±10 or ±20	B/Y5P/2B4	10.5	7.5	0.65
ECKDNB102 □ B	1000	±10 or ±20	B/Y5P/2B4	10.5	7.5	0.65
ECKDNB152 □ B	1500	±20	E/Y5U/2E4	10.5	7.5	0.65
ECKDNB222 □ B	2200	±20	E/Y5U/2E4	10.5	7.5	0.65
ECKDNB332 □ B	3300	±20	E/Y5U/2E4	13.0	10.0	0.65
ECKDNB472 □ B	4700	±20	E/Y5U/2E4	16.0	10.0	0.65

* □ Capacitance tolerance code, "K" for ±10% or "M" for ±20%

** Radial taped versions are available on request.

Regarding previous recognized capacitors "Type NS"

- Following previous recognized capacitors "Type NS" (4 items) in the table are applicable to UL (125V) and CSA.
- Following capacitors "Type NS" (4 items) do not conform to "New European Safety Standards" based on IEC384-14, 2nd edition.

Part Number	Capacitance		Temperature Characteristics	Dimensions in mm		
	Nominal Capacitance (pF)	Tolerance (%)		D max.	F	d
ECKDNS103ME	10000	±20	E/Y5U/2E4	22.0	10.0	0.65
ECKDNS472ZV	4700	+80, -20	V/Z5V	12.0	7.5	0.65
ECKDNS103ZV	10000	+80, -20	V/Z5V	17.5	10.0	0.65
ECKDNS223ZV	22000	+80, -20	V/Z5V	24.0	10.0	0.65