

### PNP Silicon RF Transistor

- For low distortion broadband amplifiers in antenna and telecommunications systems up to 1.5 GHz at collector currents from 20mA to 80mA

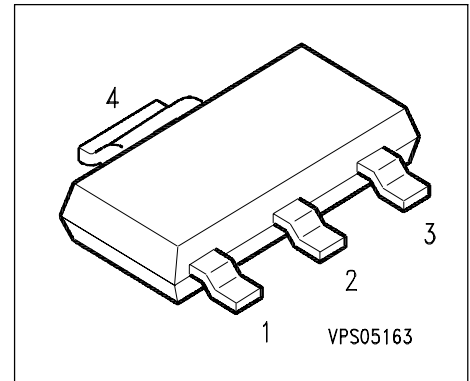

**ESD: Electrostatic discharge sensitive device, observe handling precaution!**

Type	Marking	Ordering Code	Pin Configuration				Package
BFG 194	BFG194	Q62702-F1321	1 = E	2 = B	3 = E	4 = C	SOT-223

### Maximum Ratings

Parameter	Symbol	Values	Unit
Collector-emitter voltage	$V_{CEO}$	15	V
Collector-base voltage	$V_{CBO}$	20	
Emitter-base voltage	$V_{EBO}$	3	
Collector current	$I_C$	100	mA
Base current	$I_B$	10	
Total power dissipation $T_S \leq 75^\circ\text{C}$	$P_{tot}$	1000	mW
Junction temperature	$T_j$	150	°C
Ambient temperature	$T_A$	- 65 ... + 150	
Storage temperature	$T_{stg}$	- 65 ... + 150	

### Thermal Resistance

Junction - soldering point <sup>1)</sup>	$R_{thJS}$	$\leq 75$	K/W
--	------------	-----------	-----

1)  $T_S$  is measured on the collector lead at the soldering point to the pcb.

**Electrical Characteristics** at  $T_A = 25^\circ\text{C}$ , unless otherwise specified.

Parameter	Symbol	Values			Unit
		min.	typ.	max.	
<b>DC Characteristics</b>					
Collector-emitter breakdown voltage $I_C = 1 \text{ mA}, I_B = 0$	$V_{(BR)CEO}$	15	-	-	V
Collector-base cutoff current $V_{CB} = 10 \text{ V}, I_E = 0$	$I_{CBO}$	-	-	100	nA
Emitter-base cutoff current $V_{EB} = 2 \text{ V}, I_C = 0$	$I_{EBO}$	-	-	1	$\mu\text{A}$
DC current gain $I_C = 70 \text{ mA}, V_{CE} = 8 \text{ V}$	$h_{FE}$	15	50	-	-

**Electrical Characteristics** at  $T_A = 25^\circ\text{C}$ , unless otherwise specified.

Parameter	Symbol	Values			Unit
		min.	typ.	max.	
<b>AC Characteristics</b>					
Transition frequency $I_C = 70 \text{ mA}$ , $V_{CE} = 8 \text{ V}$ , $f = 500 \text{ MHz}$	$f_T$	3.5	5	-	GHz
Collector-base capacitance $V_{CB} = 10 \text{ V}$ , $V_{BE} = v_{be} = 0$ , $f = 1 \text{ MHz}$	$C_{cb}$	-	1.4	2	pF
Collector-emitter capacitance $V_{CE} = 10 \text{ V}$ , $V_{BE} = v_{be} = 0$ , $f = 1 \text{ MHz}$	$C_{ce}$	-	0.4	-	
Emitter-base capacitance $V_{EB} = 0.5 \text{ V}$ , $V_{CB} = v_{cb} = 0$ , $f = 1 \text{ MHz}$	$C_{eb}$	-	4.7	-	
Noise figure $I_C = 20 \text{ mA}$ , $V_{CE} = 8 \text{ V}$ , $Z_S = Z_{\text{Sopt}}$ $f = 900 \text{ MHz}$ $f = 1.8 \text{ GHz}$	$F$	-	2.8 4.7	-	dB
Power gain <sup>2)</sup> $I_C = 70 \text{ mA}$ , $V_{CE} = 8 \text{ V}$ , $Z_S = Z_{\text{Sopt}}$ $Z_L = Z_{\text{Lopt}}$ $f = 900 \text{ MHz}$ $f = 1.8 \text{ GHz}$	$G_{\text{ma}}$	-	11 6.5	-	
Transducer gain $I_C = 70 \text{ mA}$ , $V_{CE} = 8 \text{ V}$ , $Z_S = 50 \Omega$ $f = 900 \text{ MHz}$ $f = 1.8 \text{ GHz}$	$ S_{21e} ^2$	-	8 3	-	

2)  $G_{\text{ma}} = |S_{21}/S_{12}| (k - (k^2 - 1)^{1/2})$

### Total power dissipation $P_{tot} = f(T_A^*, T_S)$

\* Package mounted on epoxy

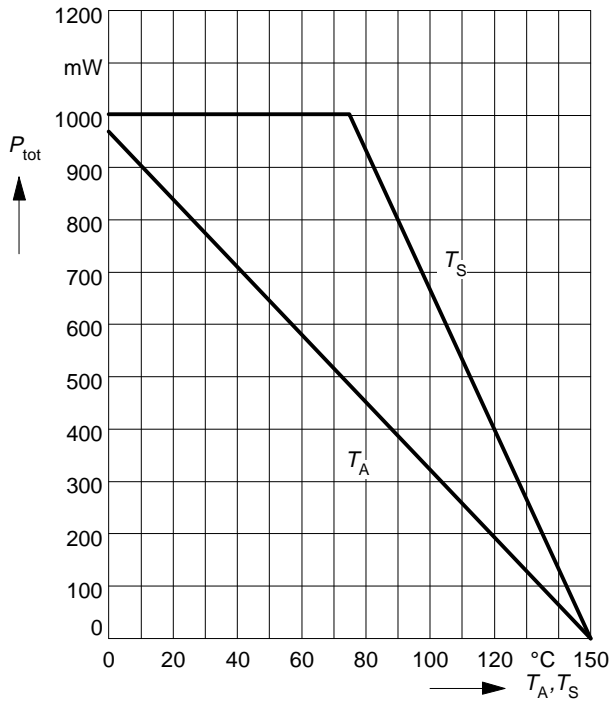

### Permissible Pulse Load $R_{thJS} = f(t_p)$

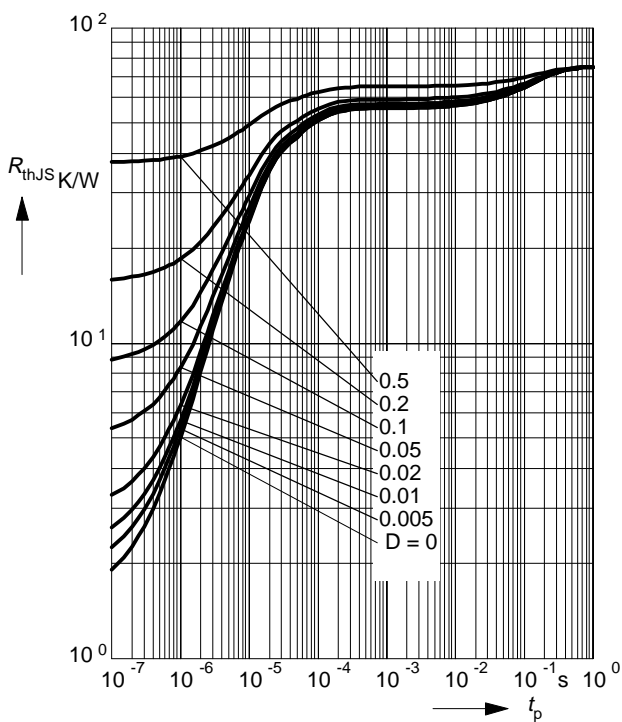

### Permissible Pulse Load $P_{totmax}/P_{totDC} = f(t_p)$

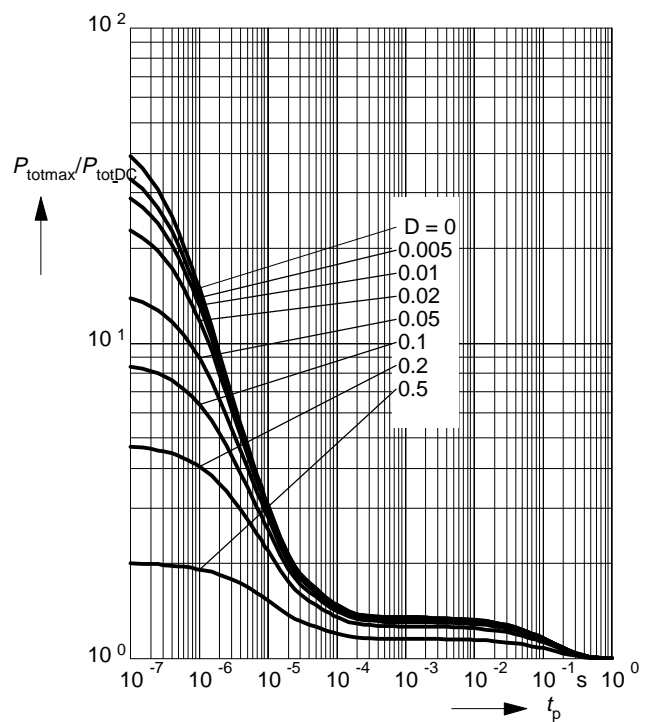

### Collector-base capacitance $C_{cb} = f(V_{CB})$

$V_{BE} = v_{be} = 0, f = 1\text{MHz}$

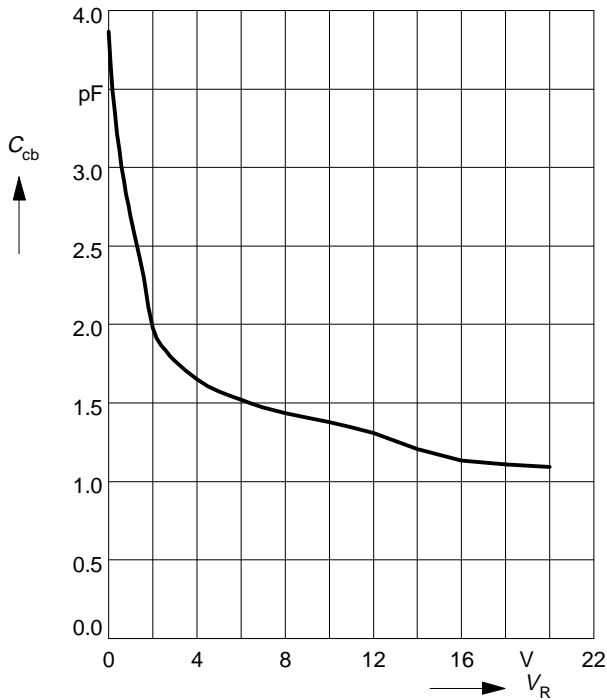

### Transition frequency $f_T = f(I_C)$

$V_{CE} = \text{Parameter}$

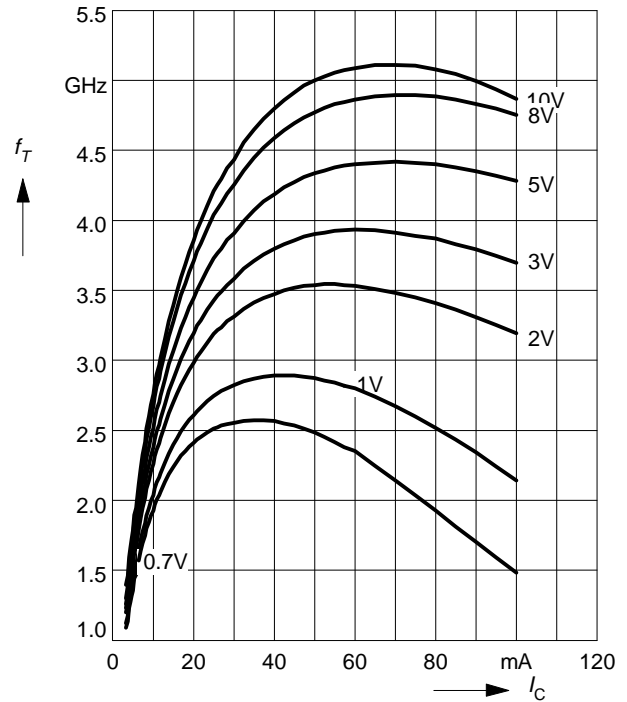

### Power Gain $G_{ma}, G_{ms} = f(I_C)$

$f = 0.9\text{GHz}$

$V_{CE} = \text{Parameter}$

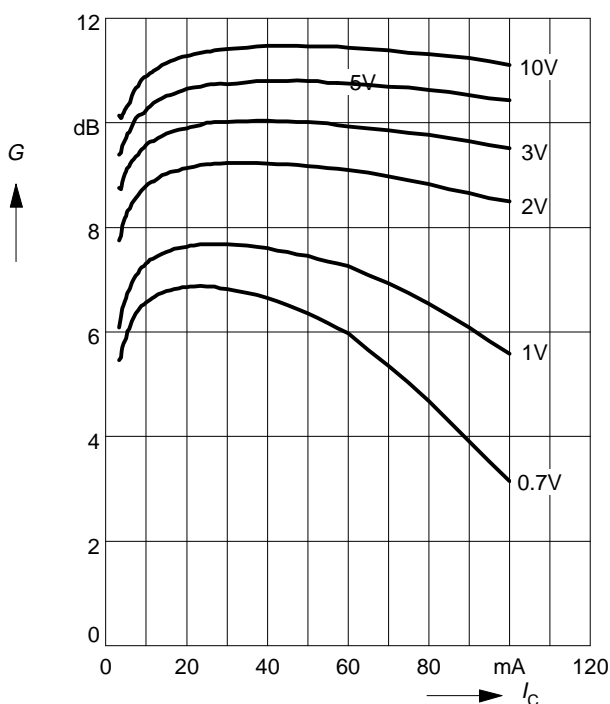

### Power Gain $G_{ma}, G_{ms} = f(I_C)$

$f = 1.8\text{GHz}$

$V_{CE} = \text{Parameter}$

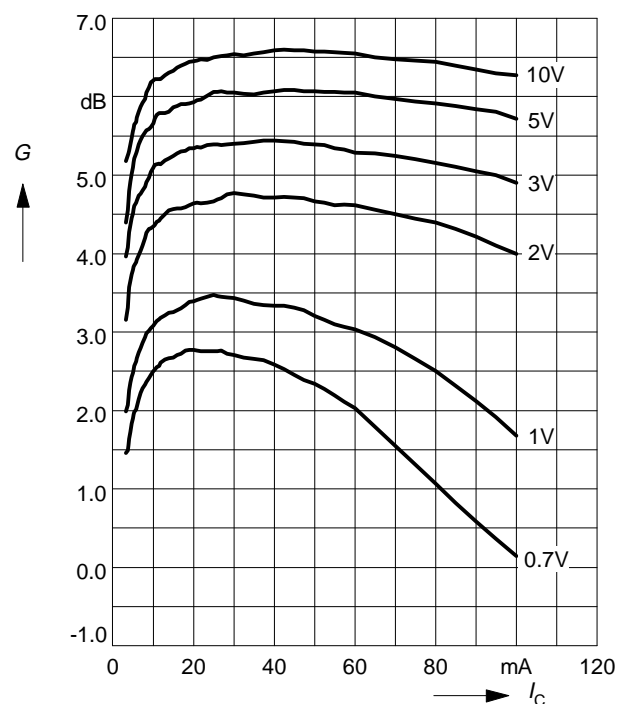

**Power Gain**  $G_{ma}, G_{ms} = f(V_{CE})$ : \_\_\_\_\_  
 $|S_{21}|^2 = f(V_{CE})$ : - - - - -

$f =$  Parameter

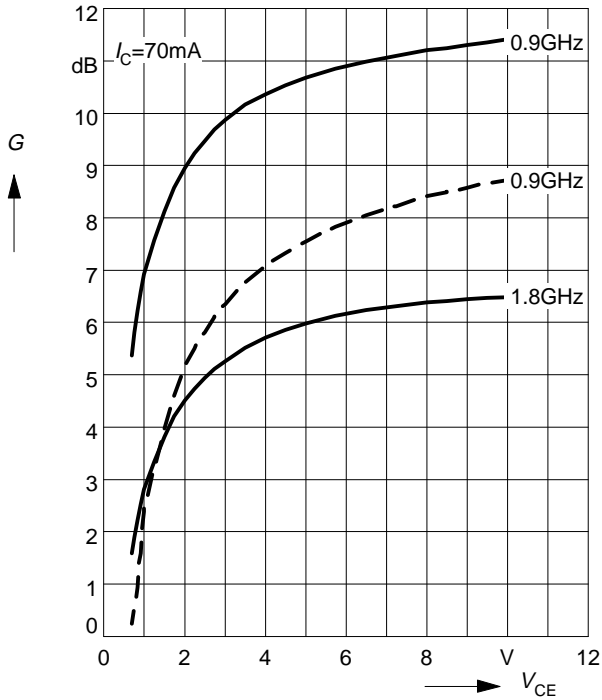

**Intermodulation Intercept Point**  $IP_3 = f(I_C)$   
 (3rd order, Output,  $Z_S = Z_L = 50\Omega$ )

$V_{CE} =$  Parameter,  $f = 900\text{MHz}$

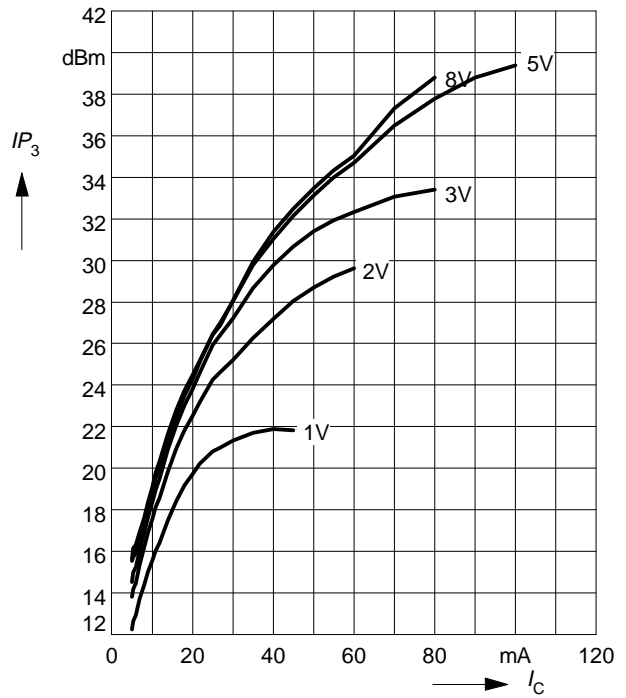

**Power Gain**  $G_{ma}, G_{ms} = f(f)$

$V_{CE} =$  Parameter

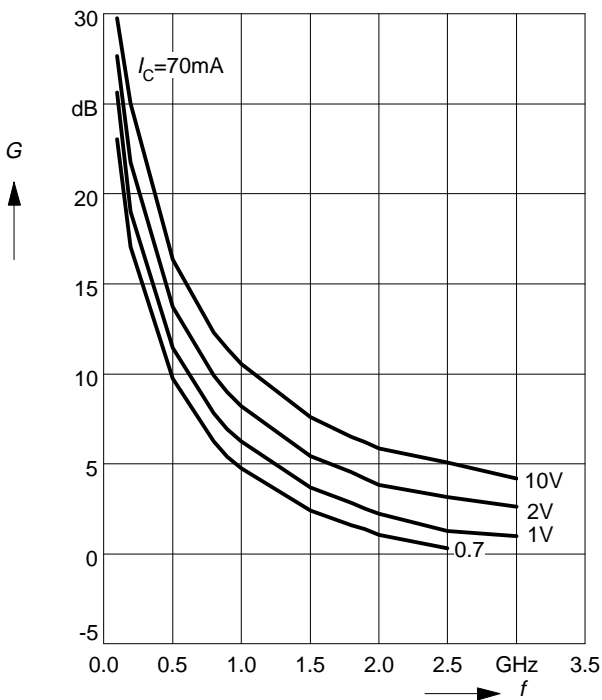

**Power Gain**  $|S_{21}|^2 = f(f)$

$V_{CE} =$  Parameter

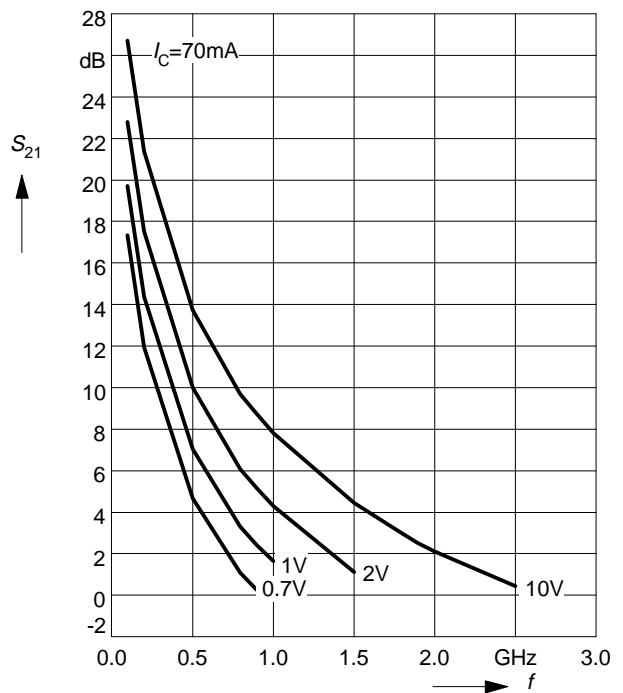

## Package

