

# CEP7050L/CEB7050L

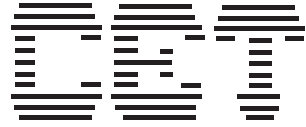

March 1998

4

## N-Channel Logic Level Enhancement Mode Field Effect Transistor

### FEATURES

- 55V , 75A ,  $R_{DS(ON)}=13m\Omega$  @  $V_{GS}=5V$ .
- Super high dense cell design for extremely low  $R_{DS(ON)}$ .
- High power and current handling capability.
- TO-220 & TO-263 package.

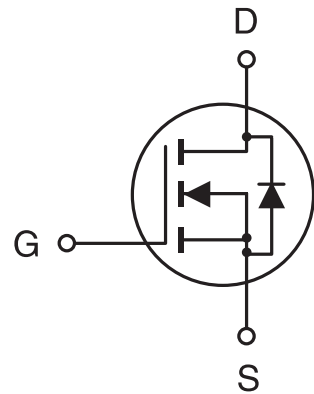

### ABSOLUTE MAXIMUM RATINGS (Tc=25°C unless otherwise noted)

Parameter	Symbol	Limit	Unit
Drain-Source Voltage	V <sub>DS</sub>	55	V
Gate-Source Voltage	V <sub>GS</sub>	±20	V
Drain Current-Continuous -Pulsed	I <sub>D</sub>	75	A
	I <sub>DM</sub>	225	A
Drain-Source Diode Forward Current	I <sub>S</sub>	75	A
Maximum Power Dissipation @T <sub>c</sub> =25°C Derate above 25°C	P <sub>D</sub>	150	W
		1	W/°C
Operating and Storage Temperature Range	T <sub>J</sub> , T <sub>STG</sub>	-65 to 175	°C

### THERMAL CHARACTERISTICS

Thermal Resistance, Junction-to-Case	R <sub>θJC</sub>	1	°C/W
Thermal Resistance, Junction-to-Ambient	R <sub>θJA</sub>	62.5	°C/W

# CEP7050L/CEB7050L

## ELECTRICAL CHARACTERISTICS (Tc=25°C unless otherwise noted)

4

Parameter	Symbol	Condition	Min	Typ	Max	Unit
<b>OFF CHARACTERISTICS</b>						
Drain-Source Breakdown Voltage	BV <sub>DSS</sub>	V <sub>GS</sub> =0V, I <sub>D</sub> =250μA	55			V
Zero Gate Voltage Drain Current	I <sub>DSS</sub>	V <sub>DS</sub> =55V, V <sub>GS</sub> =0V			25	μA
Gate-Body Leakage	I <sub>GSS</sub>	V <sub>GS</sub> =±20V, V <sub>DS</sub> =0V			±100	nA
<b>ON CHARACTERISTICS<sup>a</sup></b>						
Gate Threshold Voltage	V <sub>GS(th)</sub>	V <sub>DS</sub> =V <sub>GS</sub> , I <sub>D</sub> =250μA	1	1.3	2	V
Drain-Source On-State Resistance	R <sub>DS(ON)</sub>	V <sub>GS</sub> =5V, I <sub>D</sub> =37.5A		10	13	mΩ
On-State Drain Current	I <sub>D(ON)</sub>	V <sub>GS</sub> =5V, V <sub>DS</sub> =10V	60			A
Forward Transconductance	g <sub>FS</sub>	V <sub>DS</sub> =10V, I <sub>D</sub> =37.5A		60		S
<b>DYNAMIC CHARACTERISTICS<sup>b</sup></b>						
Input Capacitance	C <sub>ISS</sub>	V <sub>DS</sub> =25V, V <sub>GS</sub> =0V f=1.0MHz		2730	3600	pF
Output Capacitance	C <sub>OSS</sub>			723	1000	pF
Reverse Transfer Capacitance	C <sub>RSS</sub>			128	170	pF
<b>SWITCHING CHARACTERISTICS<sup>b</sup></b>						
Turn-On Delay Time	t <sub>D(ON)</sub>	V <sub>DD</sub> =30V, I <sub>D</sub> =75A, V <sub>GS</sub> =5V, R <sub>GEN</sub> =10Ω		25	40	ns
Rise Time	t <sub>r</sub>			470	600	ns
Turn-Off Delay Time	t <sub>D(OFF)</sub>			60	150	ns
Fall Time	t <sub>f</sub>			180	400	ns
Total Gate Charge	Q <sub>g</sub>	V <sub>DS</sub> =48V, I <sub>D</sub> =75A, V <sub>GS</sub> =5V		104	115	nC
Gate-Source Charge	Q <sub>gs</sub>			14		nC
Gate-Drain Charge	Q <sub>gd</sub>			18		nC

# CEP7050L/CEB7050L

4

## ELECTRICAL CHARACTERISTICS ( $T_c=25^\circ\text{C}$ unless otherwise noted)

Parameter	Symbol	Condition	Min	Typ	Max	Unit
<b>DRAIN-SOURCE DIODE CHARACTERISTICS <sup>a</sup></b>						
Diode Forward Voltage	$V_{SD}$	$V_{GS} = 0V, I_s = 37.5A$		0.9	1.3	V

Notes

a. Pulse Test: Pulse Width  $\leq 300 \mu s$ , Duty Cycle  $\leq 2\%$ .

b. Guaranteed by design, not subject to production testing.

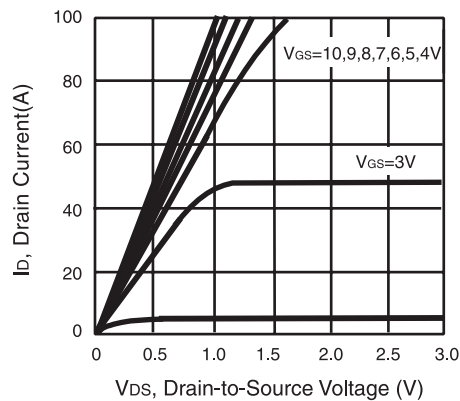

Figure 1. Output Characteristics

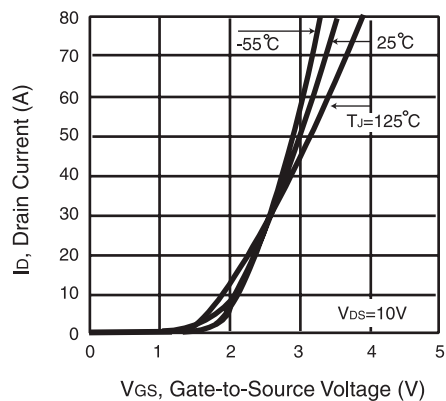

Figure 2. Transfer Characteristics

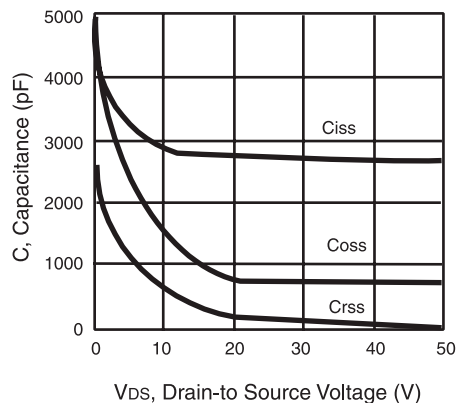

Figure 3. Capacitance

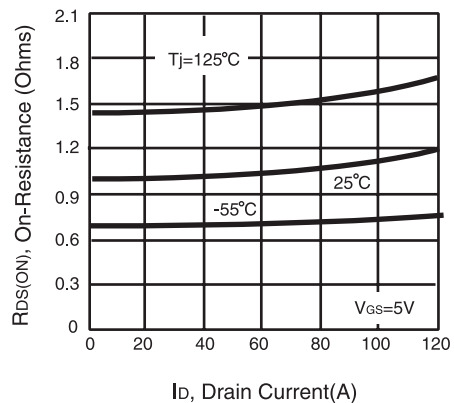
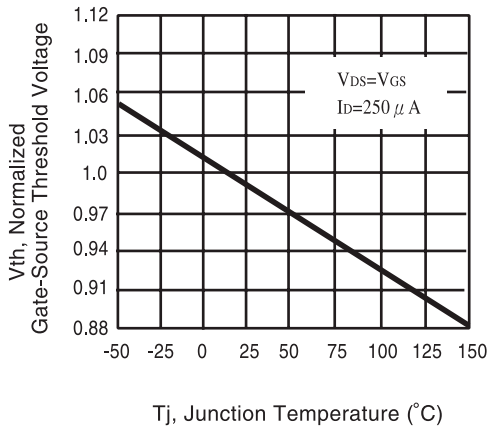

Figure 4. On-Resistance Variation with Drain Current and Temperature

# CEP7050L/CEB7050L

4



**Figure 5. Gate Threshold Variation with Temperature**

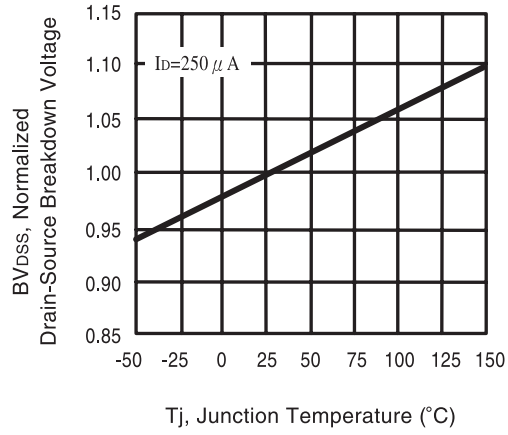

**Figure 6. Breakdown Voltage Variation with Temperature**

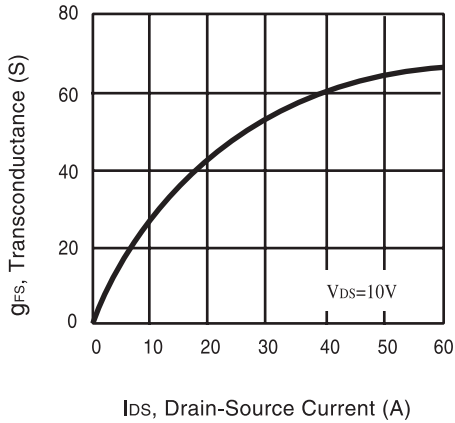

**Figure 7. Transconductance Variation with Drain Current**

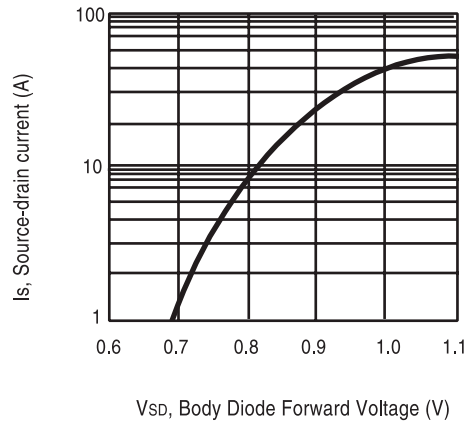

**Figure 8. Body Diode Forward Voltage Variation with Source Current**

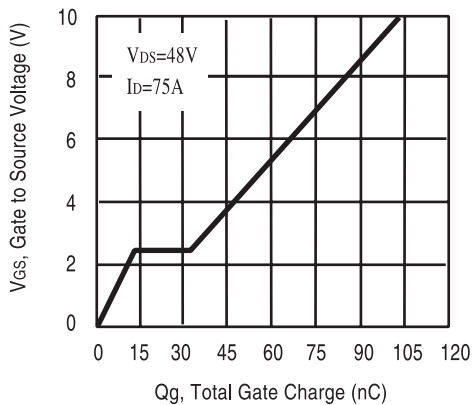

**Figure 9. Gate Charge**

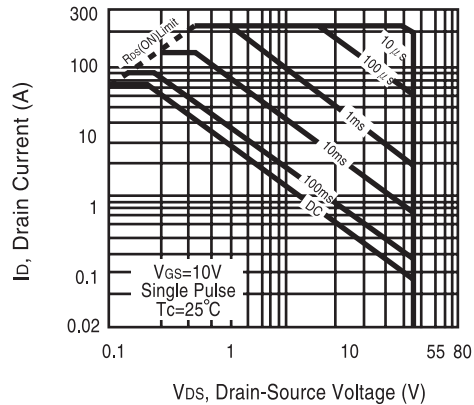

**Figure 10. Maximum Safe Operating Area**

# CEP7050L/CEB7050L

4

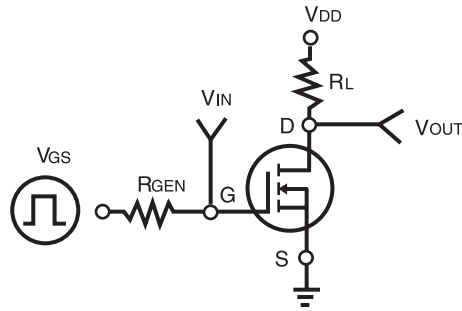

Figure 11. Switching Test Circuit

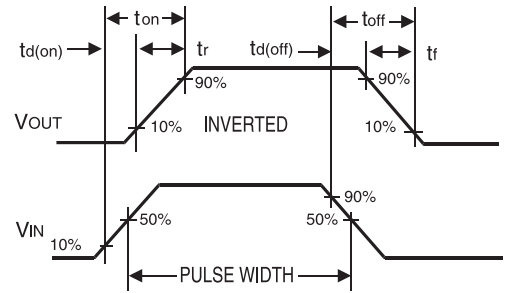

Figure 12. Switching Waveforms

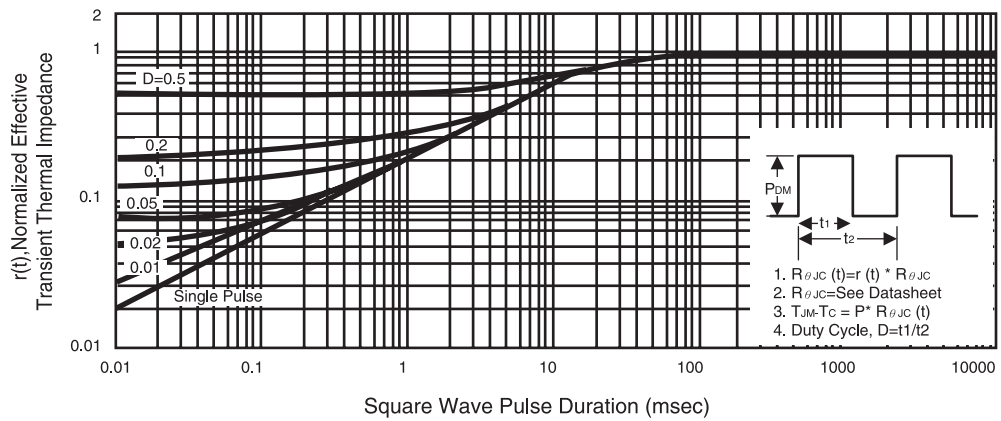

Figure 13. Normalized Thermal Transient Impedance Curve