

The RF Line

NPN Silicon

RF Power Transistor

Designed for 12.5 volt low band VHF large-signal power amplifier applications in commercial and industrial FM equipment.

- Specified 12.5 V, 50 MHz Characteristics —
 - Output Power = 70 W
 - Minimum Gain = 11 dB
 - Efficiency = 50%
- Load Mismatch Capability at High Line and RF Overdrive

MRF492

**70 W, 50 MHz
RF POWER
TRANSISTOR
NPN SILICON**

MAXIMUM RATINGS

Rating	Symbol	Value	Unit
Collector–Emitter Voltage	V_{CEO}	18	Vdc
Collector–Base Voltage	V_{CBO}	36	Vdc
Emitter–Base Voltage	V_{EBO}	4.0	Vdc
Collector Current — Continuous	I_C	20	Adc
Total Device Dissipation @ $T_C = 25^\circ\text{C}$ (1) Derate above 25°C	P_D	250 1.43	Watts W/ $^\circ\text{C}$
Storage Temperature Range	T_{stg}	–65 to +150	$^\circ\text{C}$

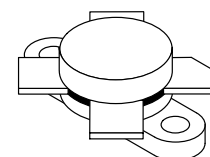

CASE 211–11, STYLE 1

THERMAL CHARACTERISTICS

Characteristic	Symbol	Max	Unit
Thermal Resistance, Junction to Case (2)	$R_{\theta JC}$	0.7	$^\circ\text{C}/\text{W}$

ELECTRICAL CHARACTERISTICS ($T_C = 25^\circ\text{C}$ unless otherwise noted.)

Characteristic	Symbol	Min	Typ	Max	Unit
----------------	--------	-----	-----	-----	------

OFF CHARACTERISTICS

Collector–Emitter Breakdown Voltage ($I_C = 100$ mAdc, $I_B = 0$)	$V_{(BR)CEO}$	18	—	—	Vdc
Collector–Emitter Breakdown Voltage ($I_C = 50$ mAdc, $V_{BE} = 0$)	$V_{(BR)CES}$	36	—	—	Vdc
Emitter–Base Breakdown Voltage ($I_E = 10$ mAdc, $I_C = 0$)	$V_{(BR)EBO}$	4.0	—	—	Vdc
Collector Cutoff Current ($V_{CE} = 13.6$ Vdc, $V_{BE} = 0$)	I_{CES}	—	—	20	mAdc

ON CHARACTERISTICS

DC Current Gain ($I_C = 5.0$ Adc, $V_{CE} = 5.0$ Vdc)	h_{FE}	10	—	150	—
--	----------	----	---	-----	---

DYNAMIC CHARACTERISTICS

Output Capacitance ($V_{CB} = 15$ Vdc, $I_E = 0$, $f = 1.0$ MHz)	C_{ob}	—	275	450	pF
--	----------	---	-----	-----	----

FUNCTIONAL TESTS

Common–Emitter Amplifier Power Gain ($V_{CC} = 12.5$ Vdc, $P_{out} = 70$ W, $f = 50$ MHz)	G_{PE}	11	13	—	dB
Collector Efficiency ($V_{CC} = 12.5$ Vdc, $P_{out} = 70$ W, $f = 50$ MHz)	η	50	—	—	%

NOTES:

- These devices are designed for RF operation. The total device dissipation rating applies only when the devices are operated as RF amplifiers.
- Thermal Resistance is determined under specified RF operating conditions by infrared measurement techniques.

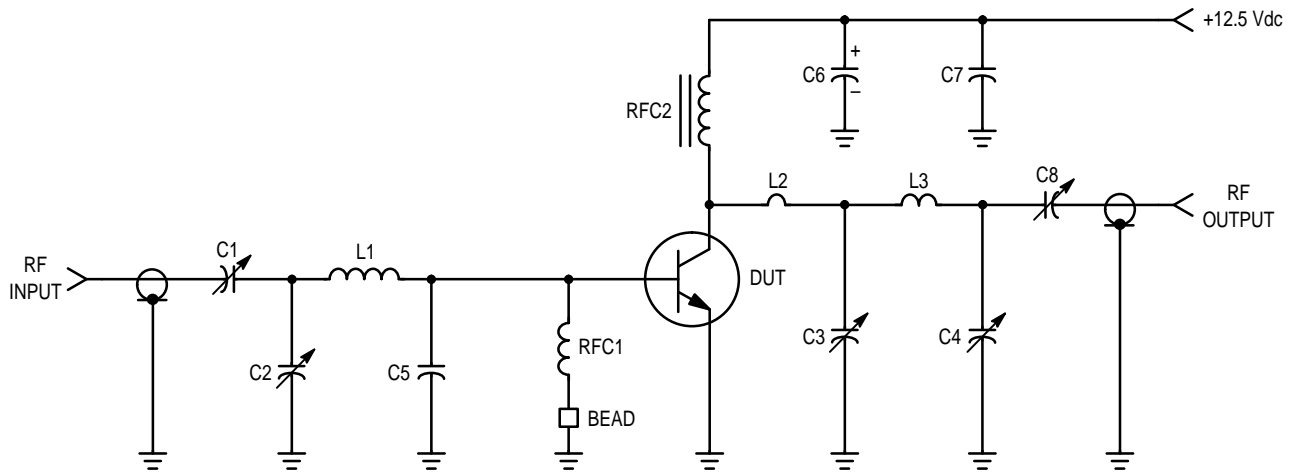

C1, C8 — 9.0–180 pF, Arco 463
 C2, C3, C4 — 80–480 pF, Arco 466
 C5 — 1000 pF, 350 V, Unelco
 C6 — 10 μ F, 25 Vdc
 C7 — 0.01 μ F, Ceramic
 RFC1 — 10 μ H Molded Choke

RFC2 — 12 Turns, #16 AWG, Enameled Wire Closewound
 on a 2.0 W Carbon Resistor
 L1 — 2 Turns, #18 AWG Enameled Wire, 0.4" ID, 0.15" Long
 L2 — Loop, #12 AWG Wire, 0.6" High, 0.4" Wide
 L3 — 2 Turns, #12 AWG Wire, ID 0.4", 0.25" Long
 Bead — Ferrite Bead Ferroxcube #56–590–65/3B

Figure 1. 50 MHz Test Circuit

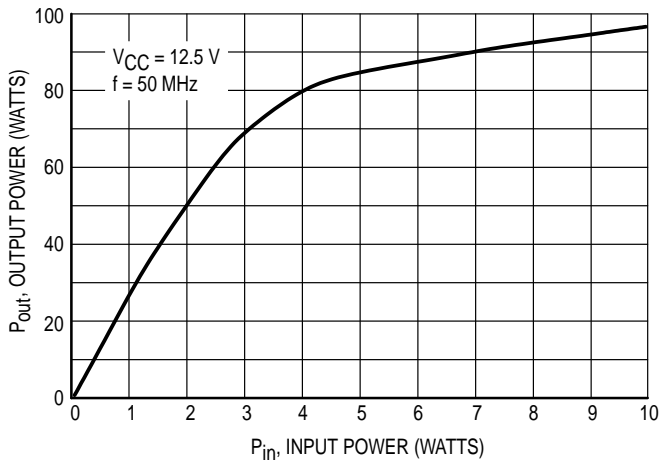

Figure 2. Output Power versus Input Power

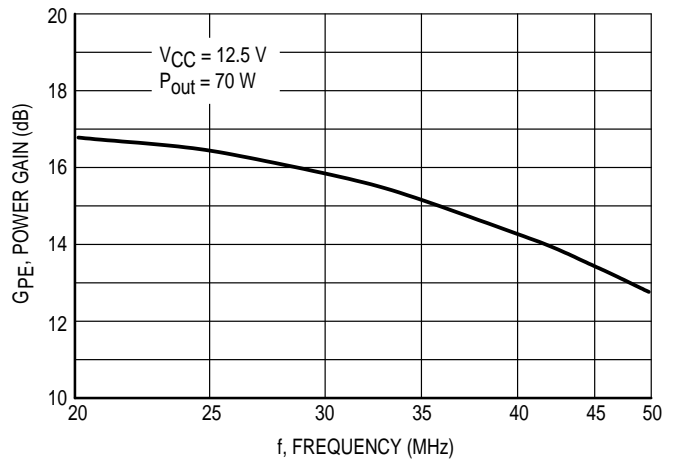

Figure 3. Power Gain versus Frequency

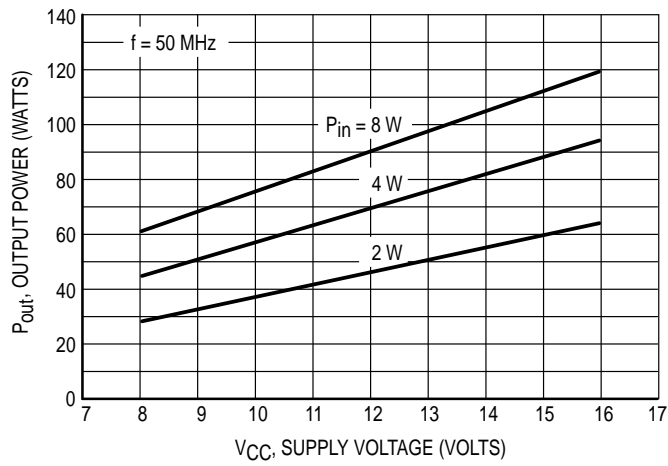

Figure 4. Output Power versus Supply Voltage

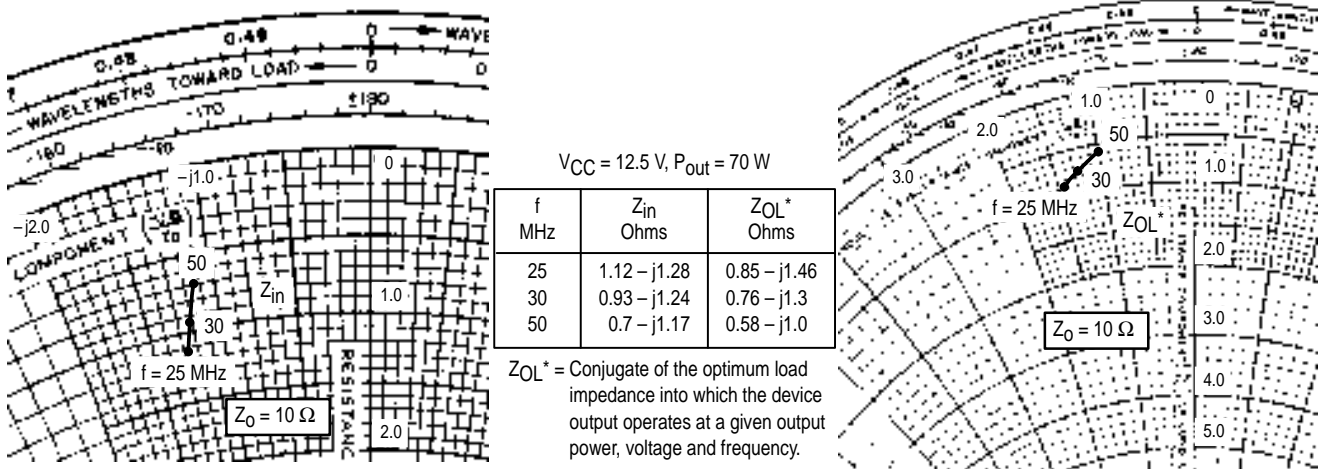
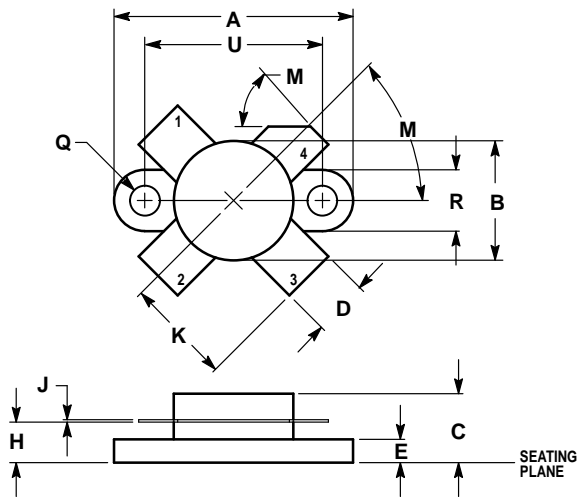

Figure 5. Series Equivalent Input/Output Impedances

PACKAGE DIMENSIONS



- NOTES:
 1. DIMENSIONING AND TOLERANCING PER ANSI Y14.5M, 1982.
 2. CONTROLLING DIMENSION: INCH.

DIM	INCHES		MILLIMETERS	
	MIN	MAX	MIN	MAX
A	0.960	0.990	24.39	25.14
B	0.465	0.510	11.82	12.95
C	0.229	0.275	5.82	6.98
D	0.216	0.235	5.49	5.96
E	0.084	0.110	2.14	2.79
H	0.144	0.178	3.66	4.52
J	0.003	0.007	0.08	0.17
K	0.435	—	11.05	—
M	45°NOM		45°NOM	
Q	0.115	0.130	2.93	3.30
R	0.246	0.255	6.25	6.47
U	0.720	0.730	18.29	18.54

- STYLE 1:
 PIN 1. EMITTER
 2. BASE
 3. EMITTER
 4. COLLECTOR

**CASE 211-11
 ISSUE N**

Motorola reserves the right to make changes without further notice to any products herein. Motorola makes no warranty, representation or guarantee regarding the suitability of its products for any particular purpose, nor does Motorola assume any liability arising out of the application or use of any product or circuit, and specifically disclaims any and all liability, including without limitation consequential or incidental damages. "Typical" parameters can and do vary in different applications. All operating parameters, including "Typicals" must be validated for each customer application by customer's technical experts. Motorola does not convey any license under its patent rights nor the rights of others. Motorola products are not designed, intended, or authorized for use as components in systems intended for surgical implant into the body, or other applications intended to support or sustain life, or for any other application in which the failure of the Motorola product could create a situation where personal injury or death may occur. Should Buyer purchase or use Motorola products for any such unintended or unauthorized application, Buyer shall indemnify and hold Motorola and its officers, employees, subsidiaries, affiliates, and distributors harmless against all claims, costs, damages, and expenses, and reasonable attorney fees arising out of, directly or indirectly, any claim of personal injury or death associated with such unintended or unauthorized use, even if such claim alleges that Motorola was negligent regarding the design or manufacture of the part. Motorola and are registered trademarks of Motorola, Inc. Motorola, Inc. is an Equal Opportunity/Affirmative Action Employer.

How to reach us:

USA/EUROPE: Motorola Literature Distribution;
 P.O. Box 20912; Phoenix, Arizona 85036. 1-800-441-2447

JAPAN: Nippon Motorola Ltd.; Tatsumi-SPD-JLDC, Toshikatsu Otsuki,
 6F Seibu-Butsuryu-Center, 3-14-2 Tatsumi Koto-Ku, Tokyo 135, Japan. 03-3521-8315

MFAX: RMFAX0@email.sps.mot.com - TOUCHTONE (602) 244-6609
INTERNET: http://Design-NET.com

HONG KONG: Motorola Semiconductors H.K. Ltd.; 8B Tai Ping Industrial Park,
 51 Ting Kok Road, Tai Po, N.T., Hong Kong. 852-26629298



MRF492/D

