

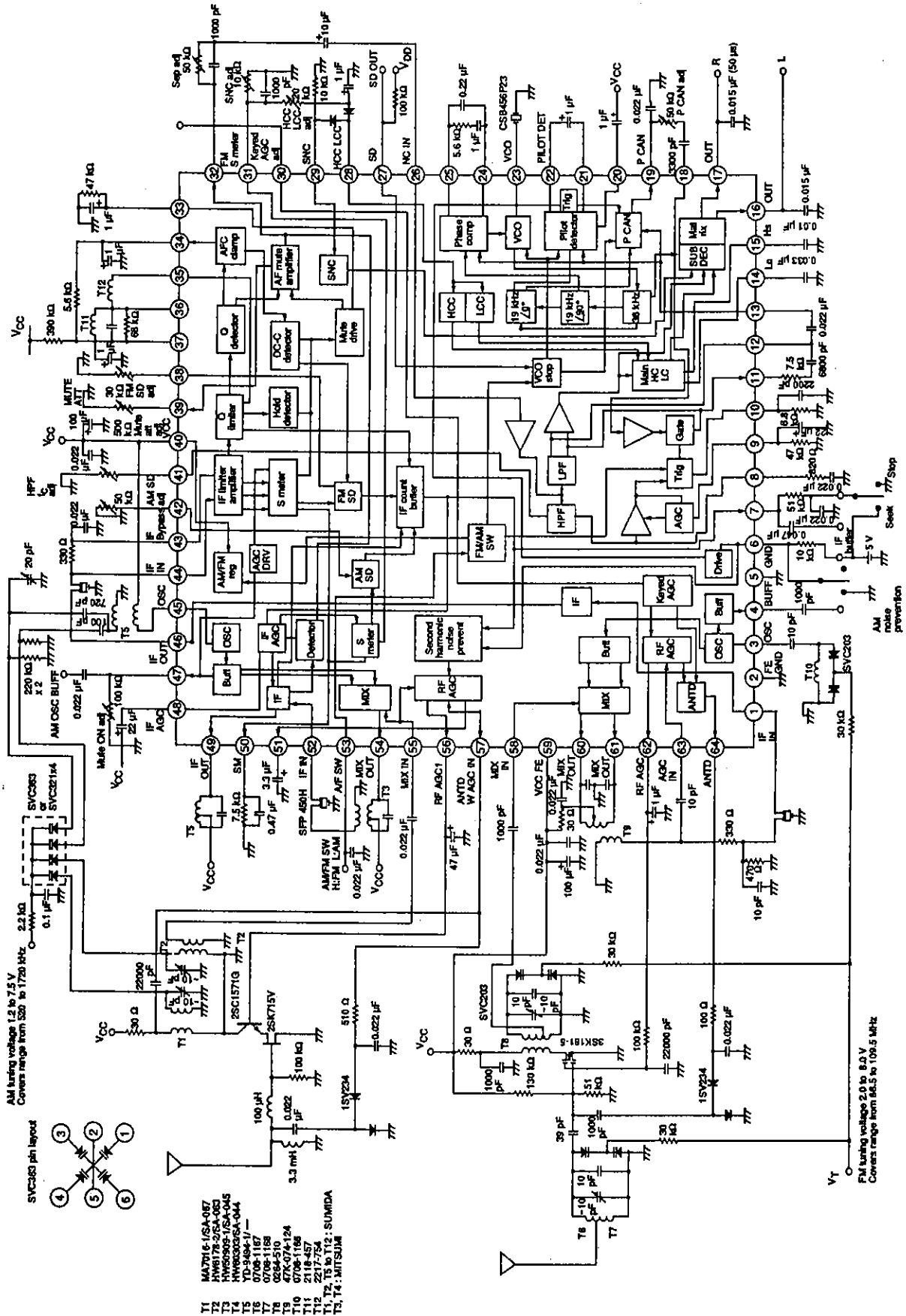

**SCHEMATIC DIAGRAM**



PIN DESCRIPTION



FM Front-end

Number	Name	Equivalent circuit	Description
58	MIX IN		Mixer input
59	FE VCC		Front-end supply voltage
60,61	MIX OUT		Mixer outputs
62	RF AGC		RF automatic gain control
63	AGC IN		Wideband automatic-gain-control input. Coupling capacitor is on-chip.

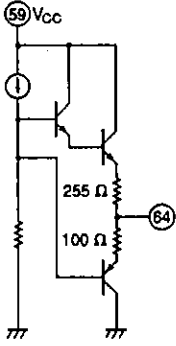
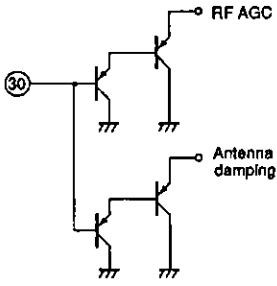
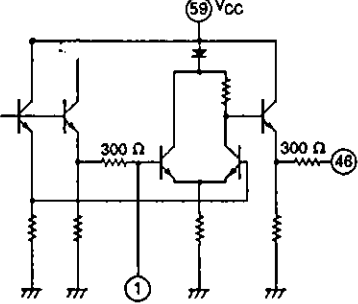
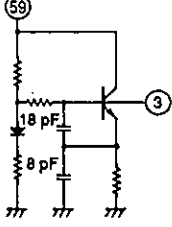
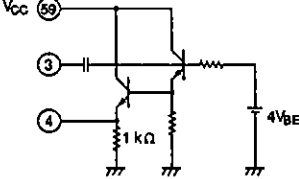
LA1886M

Number	Name	Equivalent circuit	Description
64	ANTD		Antenna damping driver output
30	KEYED AGC		Keyed automatic gain control
1	IF AMP IN		IF amplifier input. $R_{IN} \cong 330 \Omega$
46	IF AMP OUT		IF amplifier output. $R_{IN} \cong 330 \Omega$
3	OSC		Oscillator (Colpitts)
4	OSC BUFF		Oscillator buffer
2	FE GND		Front-end supply ground

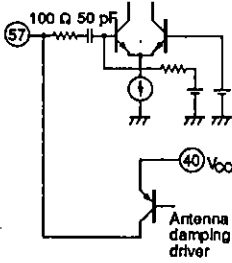
AM Tuner

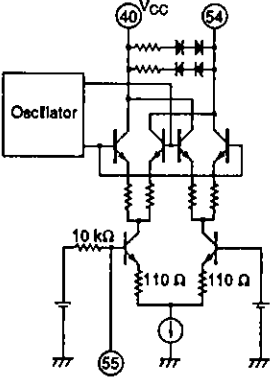
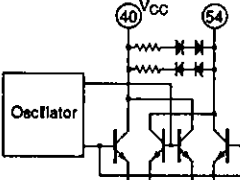
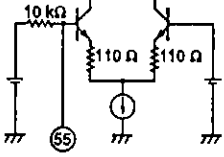
Number	Name	Equivalent circuit	Description
57	ANTD/AGC		Antenna damping driver and wideband automatic-gain-control input
56	RF AGC		RF automatic-gain-control drive output
51	RF AGC BYPASS		RF automatic-gain-control bypass output
55	MIX IN		Mixer input
54	MIX OUT		Mixer output
53	AM/FM SW		AM/FM switch
52	IF AMP IN		IF amplifier input. $R_{IN} = 2 \text{ k}\Omega$

LA1886M

Number	Name	Equivalent circuit	Description
49	IF OUT		IF stage output
50	AM/FM S-MET OUT		AM/FM S-meter current drive output
48	IF AGC BYPASS		IF automatic-gain-control bypass
47	AM OSC BUFF		AM oscillator buffer and FM muting ON level adjustment

LA1886M

Number	Name	Equivalent circuit	Description
45	OSC		Automatic-level-controlled oscillator
42	AM SD		AM signal detector output adjustment

FM IF Stage

Number	Name	Equivalent circuit	Description
44	FM IF IN		FM IF limiter input
43	FM IF BYPASS		FM IF limiter bypass input
39	MUTE ATT		Muting attenuation adjustment

LA1886M

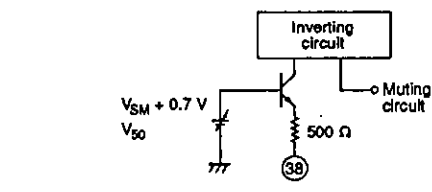
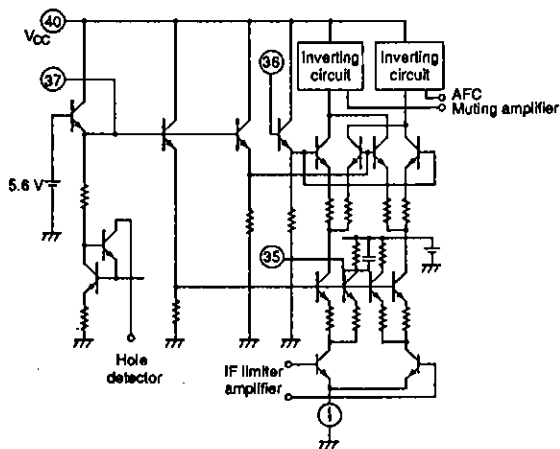
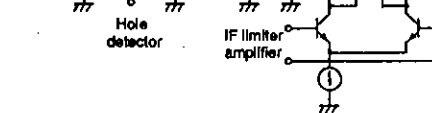
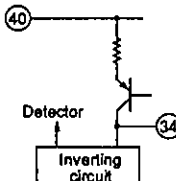
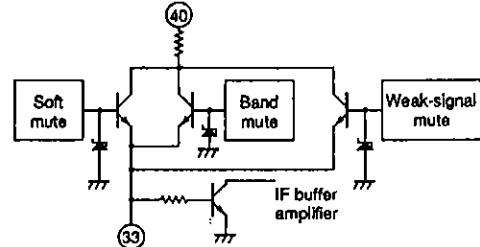
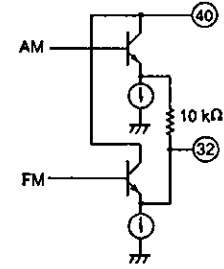
Number	Name	Equivalent circuit	Description
38	FM SD		FM signal detector output adjustment
35,36	QR DET		QR detector inputs
37	VREF		Reference voltage input
34	AFC		Automatic frequency control
33	MUTE OUT		Muting output
32	AM/FM OUT		AM/FM audio frequency output. $R_o(AM) = 10\text{ k}\Omega$ and $R_o(FM) = 50\ \Omega$



LA1886M

Number	Name	Equivalent circuit	Description
7	IF BUFF OUT		IF buffer output and muting signal input. Output impedance is capacitive.
31	FM S-MET OUT		FM S-meter output. $I_{O(AM)} = 1 \text{ mA}$ and $I_{O(FM)} = I_{50}$
27	SD		Signal detector

Noise Cancelation and Multiplex Filter Stage

Number	Name	Equivalent circuit	Description
26	NC OUT		Noise canceler output. $R_{IN} = 21 \text{ k}\Omega$

LA1886M

Number	Name	Equivalent circuit	Description
24,25	PHASE COMP		Phase comparator inputs. $R_{IN} = 20\text{ k}\Omega$
23	OSC		Oscillator
21,22	PILOT DET		Pilot detector inputs

LA1886M

Number	Name	Equivalent circuit	Description
19	PCAN OUT		Pilot canceler output
20	PCAN DET		Pilot canceler detector
18	PCAN IN		Pilot canceler signal input
16,17	MPX OUT		Multiplex filter outputs. On-chip load resistance. $R_0 = 3.3 \text{ k}\Omega$
14	LOW CUT		Low-frequency cutoff capacitor connection
15	HIGH CUT		High-frequency cutoff capacitor connection

LA1886M

Number	Name	Equivalent circuit	Description
13	PILOT IN		Phase-locked-loop pilot signal input
11	MEM		Memory circuit
12	LPF OUT		Low-pass filter output
10	PULSE		Gate time pulsewidth adjustment
9	NOISE AGC		Noise automatic gain control
8	NOISE DET		Noise detector sensitivity adjustment

LA1886M

Number	Name	Equivalent circuit	Description
6	TWEET/ST		FM stereo/mono indicator output and AM second-harmonic beat noise prevention control
28	HCC/LCC		High-cut/low-cut control
29	SNC		Stereo-noise-control input
41	HPF		High-pass filter cutoff frequency adjustment

Supply Voltage

Number	Name	Equivalent circuit	Description
40	VCC		Supply voltage
5	GND		Supply ground

## SPECIFICATIONS

## Absolute Maximum Ratings

Parameter	Symbol	Rating	Unit
Supply voltage	$V_{CC}$ max	9.5	V
Power dissipation	$P_d$ max	950	mW
Operating temperature range	$T_{opr}$	-30 to 85	deg. C
Storage temperature range	$T_{stg}$	-40 to 150	deg. C

## Recommended Operating Conditions

$T_a = 25$  deg. C

Parameter	Symbol	Rating	Unit
Supply voltage	$V_{CC}$	8.5	V
Standby supply voltage	$V_{ST}$	5	V
Supply voltage range	$V_{CC}$ op	7.5 to 9.0	V

## Electrical Characteristics

## FM RF stage

$V_{CC} = 8.5$  V,  $T_a = 25$  deg. C unless otherwise noted

Parameter	Symbol	Condition	Rating			Unit
			min	typ	max	
Quiescent current	$I_{CCO-FM}$	No input	54	77	95	mA
Detector output voltage	$V_{D-FM}$	98 MHz, 100 dB $\mu$ , 1 kHz, 100% modulation	190	290	380	mV
Channel balance	$C_B$	98 MHz, 100 dB $\mu$ , 1 kHz, 100% modulation	-1.0	0	1.0	dB
Total harmonic distortion	$THD_{FM}$	98 MHz, 100 dB $\mu$ , 1 kHz, 100% modulation	-	0.6	1.2	%
Signal-to-noise ratio	$S/N_{FM}$	98 MHz, 100 dB $\mu$ , 1 kHz, 100% modulation	63	70	-	dB
AM rejection ratio	AMR	98 MHz, 100 dB $\mu$ , 1 kHz, $f_m = 1$ kHz, 30% AM modulation	32	42	-	dB
Muting attenuation	ATT	98 MHz, 100 dB $\mu$ , 1 kHz, $V_{33} = 0$ to 2 V	6	11	16	dB
		98 MHz, 100 dB $\mu$ , 1 kHz, $V_{33} = 0$ to 4 V	20	25	30	dB
Oscillator buffer output voltage	$V_{OSC\ BUFF-FM}$	No input, $f_{osc} = 108.7$ MHz	140	220	300	mV
Channel separation	Sep	98 MHz, 100 dB $\mu$ , L = 90%, pilot = 10%	23	31	-	dB
Stereo ON level	$ST_{ON}$	Pilot modulation for $V_b < 1.5$ V	1.5	2.2	4.0	%
Stereo OFF level	$ST_{OFF}$	Pilot modulation for $V_b > 3.5$ V	0.6	1.1	-	%
Main channel total harmonic distortion	$THD_{Main}$	98 MHz, 100 dB $\mu$ , L + R = 90%, pilot = 10%	-	0.7	2.0	%

LA1886M

Parameter	Symbol	Condition	Rating			Unit
			min	typ	max	
Pilot subcarrier cancellation	$P_{CAN}$	98 MHz, 100 dB $\mu$ , L + R = 90%, pilot = 10%	6.0	13.0	—	dB
Stereo-noise-control output voltage	$V_{OSUB}$	98 MHz, 100 dB $\mu$ , L - R = 90%, pilot = 10%, $V_{31}$ = 0.1 V	—	—	5.0	mV
Stereo-noise-control output attenuation	$ATT_{SNC}$	98 MHz, 100 dB $\mu$ , L - R = 90%, pilot = 10%, $V_{31}$ = 0.6 V	0.5	4.5	10.0	dB
Low-cut control output attenuation	$ATT_{LCC}$	98 MHz, 100 dB $\mu$ , L + R = 90%, pilot = 10%, $f_m$ = 100 Hz, $V_{28}$ = 0.6 V	0.3	2.5	4.8	dB
		98 MHz, 100 dB $\mu$ , L + R = 90%, pilot = 10%, $f_m$ = 100 Hz, $V_{28}$ = 0.1 V	3.5	6.5	9.0	dB
High-cut control output attenuation	$ATT_{HCC}$	98 MHz, 100 dB $\mu$ , L + R = 90%, pilot = 10%, $f_m$ = 10 kHz, $V_{28}$ = 0.6 V	0.5	4.0	8.0	dB
		98 MHz, 100 dB $\mu$ , L + R = 90%, pilot = 10%, $f_m$ = 10 kHz, $V_{28}$ = 0.1 V	17.0	20.0	23.0	dB

FM IF stage (10.7 MHz)

$V_{CC}$  = 8.5 V,  $T_a$  = 25 deg. C unless otherwise noted

Parameter	Symbol	Condition	Rating			Unit
			min	typ	max	
Input limiting level	$V_{i-lim}$	100 dB $\mu$ input, IF input for -3 dB output	—	48	59	dB $\mu$
Muting sensitivity	$V_{i-mute}$	IF input for $V_{33}$ = 2 V	25	33	41	dB $\mu$
SD sensitivity	$SD_{sen}$	IF input for IF count buffer ON	58	70	82	dB $\mu$
		IF input for $V_{27}$ > 3.5 V	58	70	82	dB $\mu$
IF count buffer output voltage	$V_{IBUFF-FM}$	100 dB $\mu$ , zero modulation	160	250	390	mV
S-meter output voltage	$V_{SM-FM}$	No input	0.0	0.2	0.5	V
		50 dB $\mu$	1.0	1.9	2.7	V
		70 dB $\mu$	1.9	3.4	5.2	V
		100 dB $\mu$	3.3	5.2	6.9	V
Muting bandwidth	$BW_{mute}$	100 dB $\mu$ , $V_{33}$ = 2 V	150	230	330	kHz

FM front-end mixer

$V_{CC}$  = 8.5 V,  $T_a$  = 25 deg. C unless otherwise noted

Parameter	Symbol	Condition	Rating			Unit
			min	typ	max	
RF AGC ON input level	$V_{F-AGC}$	Mixer input for $V_{64}$ = 0.7 V	67	74	81	dB $\mu$
Conversion gain	$A_V$	98 MHz mixer input, 70 dB $\mu$ , zero modulation	54.6	86.6	137.3	mV

LA1886M

AM RF stage

V<sub>CC</sub> = 8.5 V, T<sub>a</sub> = 25 deg. C unless otherwise noted

Parameter	Symbol	Condition	Rating			Unit
			min	typ	max	
Signal-to-noise ratio	S/N <sub>27</sub>	27 dB $\mu$ input, f <sub>m</sub> = 1 kHz, 30% modulation	16	20	-	dB
Detector output voltage	V <sub>D-AM</sub>	74 dB $\mu$ , f <sub>m</sub> = 1 kHz, 30% modulation	85	120	170	mV
Automatic-gain-control figure of merit	AGC	74 dB $\mu$ output reference, input pulse for 10 dB fall in the output	53	57	61	dB
Signal-to-noise ratio	S/N <sub>AM</sub>	74 dB $\mu$ , f <sub>m</sub> = 1 kHz, 30% modulation	45	50	-	dB
Total harmonic distortion	THD <sub>AM</sub>	74 dB $\mu$ , f <sub>m</sub> = 1 kHz, 80% modulation	-	0.4	1.0	%
S-meter output voltage	V <sub>SM-AM</sub>	No input	-	0	0.3	V
		100 dB $\mu$	3.3	4.7	7.0	V
Oscillator buffer output voltage	V <sub>OSCBUFF-AM</sub>	No input	310	370	-	mV
Wideband AGC sensitivity	W-AGC <sub>sen</sub>	1.4 MHz input, V <sub>S7</sub> = 0.7 V	93	99	105	dB $\mu$
SD sensitivity	SD <sub>sen-AM</sub>	ANT input level for IF count buffer ON	23	30	37	dB $\mu$
		ANT input level for V <sub>27</sub> > 3.5 V	23	30	37	dB $\mu$
Second-harmonic beat noise prevention sensitivity	Tweet <sub>sen</sub>	N <sub>6</sub> = 0 V, AGC ON	50	56	62	dB $\mu$
IF buffer output voltage	V <sub>IFBUFF-AM</sub>	74 dB $\mu$ , zero modulation	200	260	-	mV

Noise cancelation

V<sub>CC</sub> = 8.5 V, T<sub>a</sub> = 25 deg. C unless otherwise noted

Parameter	Symbol	Condition	Rating			Unit
			min	typ	max	
Gate time	T <sub>GATE</sub>	1 kHz, 1 $\mu$ s, 100 mV <sub>p</sub> , pulsed input	15	25	35	$\mu$ s
Noise sensitivity	S <sub>N</sub>	1 kHz, 1 $\mu$ s pulse for noise canceler ON	-	-	30	mV <sub>p</sub>



Measurement circuit

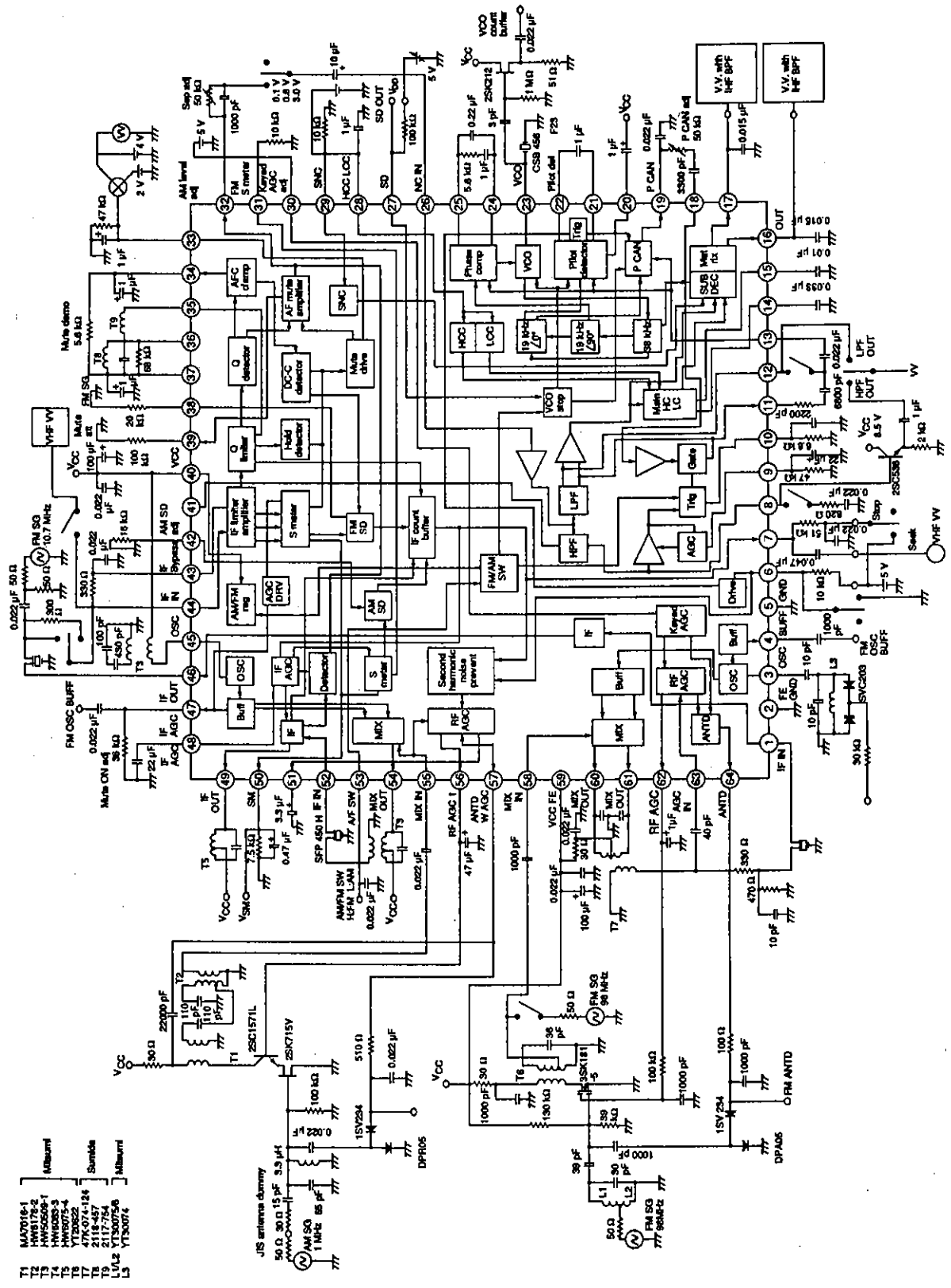

- T1 MAZ016-1
  - T2 HW8175-2
  - T3 HW85059-1
  - T4 HW8005-3
  - T5 VT10022-4
  - T6 47K-074-124
  - T7 2118-457
  - T8 2117-754
  - T9 2118-896
  - L1 VT13007-4
- JIS antenna dummy
- 50 Ω, 30 Ω 15 pF 9.9 μH
  - AM SQ 1 NPE 85 pF
  - 15V254
  - 510 Ω
  - 0.022 μF
  - DPR105
  - 1000 pF 30 Ω
  - 150 Ω
  - 2SK1811
  - 100 Ω
  - 1000 pF
  - 39 pF
  - 50 Ω
  - 30 Ω
  - 30 Ω
  - FM SQ 77 86M Hz
  - 15V254
  - 100 Ω
  - 1000 pF
  - DPA05

Typical Performance Characteristics

Overall characteristics (MPX OUT)

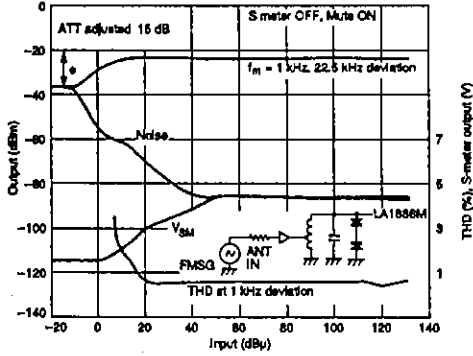

S-meter output vs. Input voltage

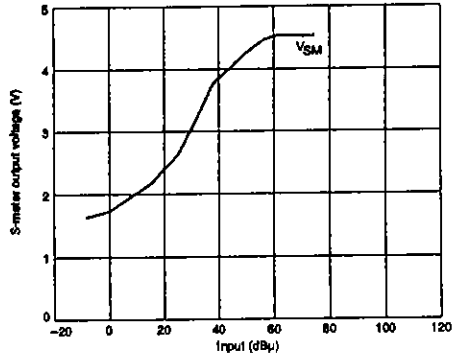

Overall characteristics (with 3SK181)

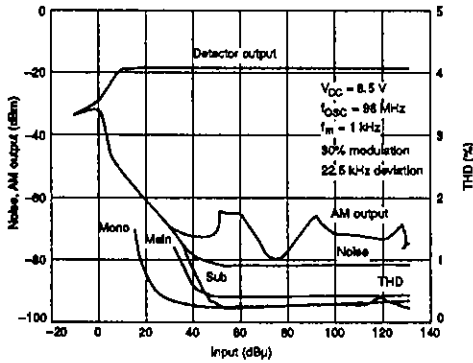

RF AGC and  $I_{ANTD}$  vs. mixer Input

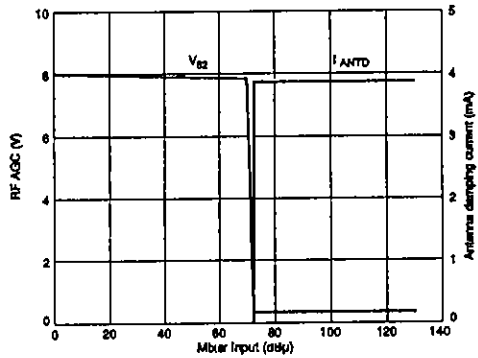

AGC voltage

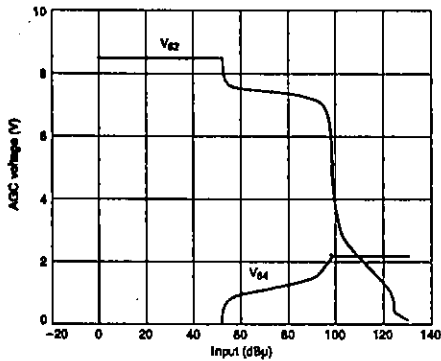

Mixer characteristics

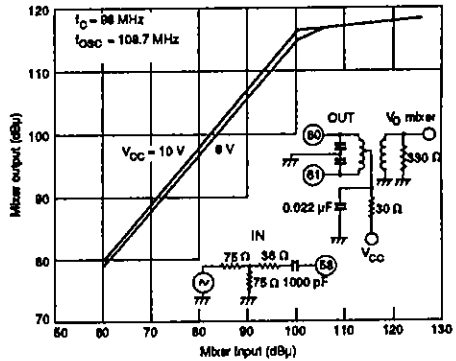

Overall characteristics (with 3SK181)

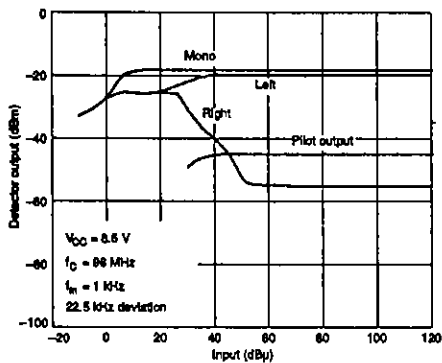

IF stage characteristics

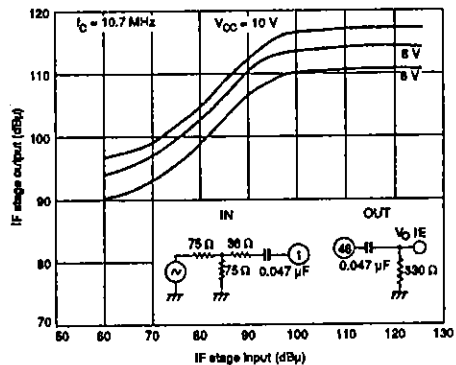

AGC characteristics

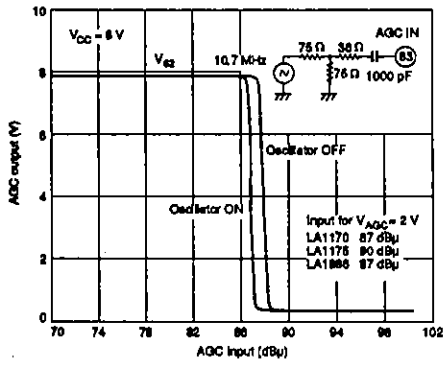

Oscillator buffer output vs. supply voltage

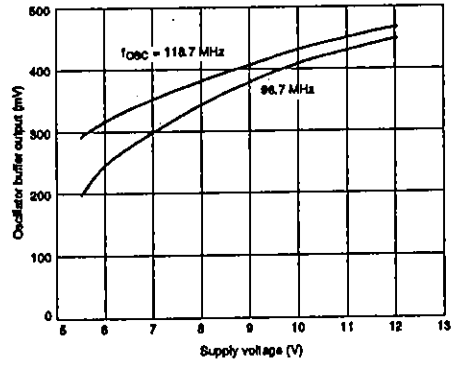

RF AGC ON level vs. supply voltage

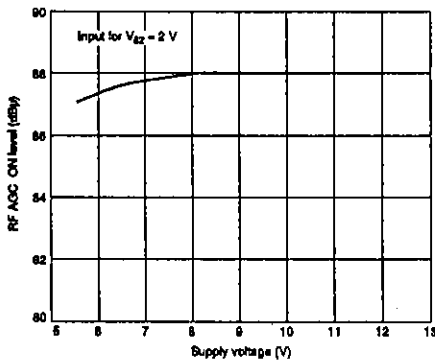

Frequency deviation vs. supply voltage

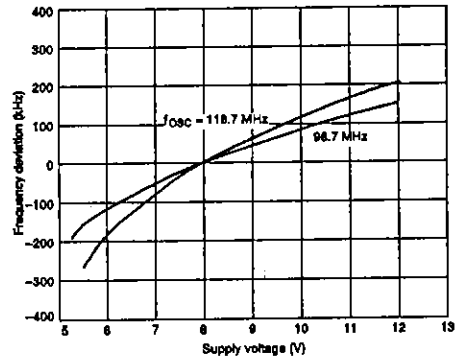

AGC Input vs. frequency deviation

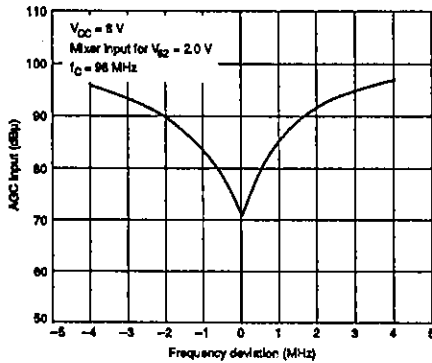

Oscillator frequency deviation vs. input

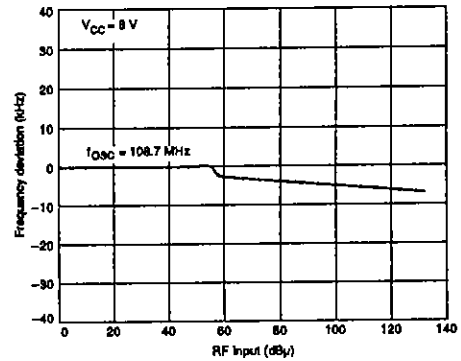

AGC Input vs. capacitance

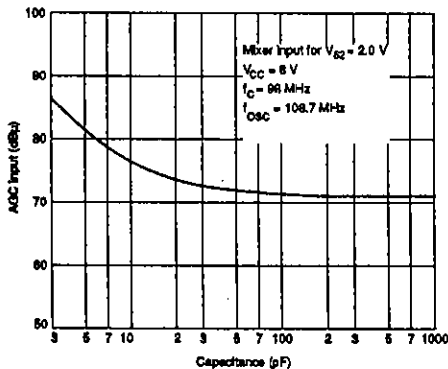

AGC frequency response

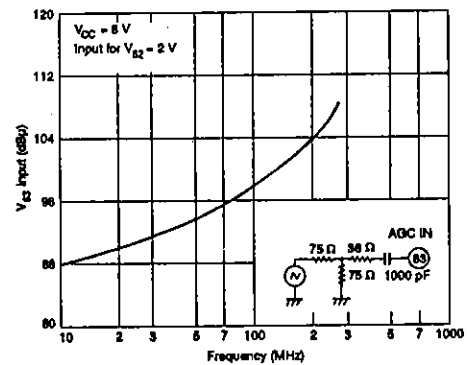

Mixer output vs. oscillator output

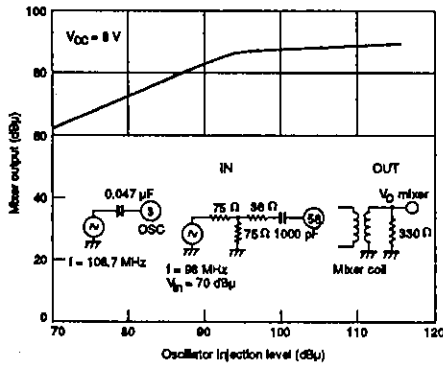

Three-signal characteristics

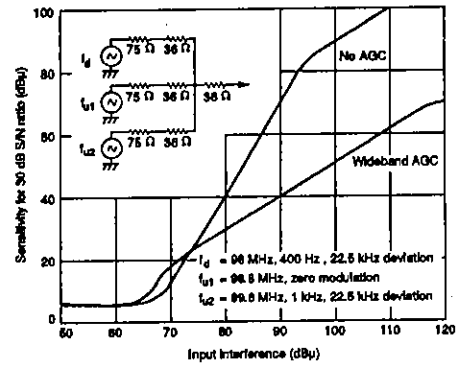

Temperature characteristics

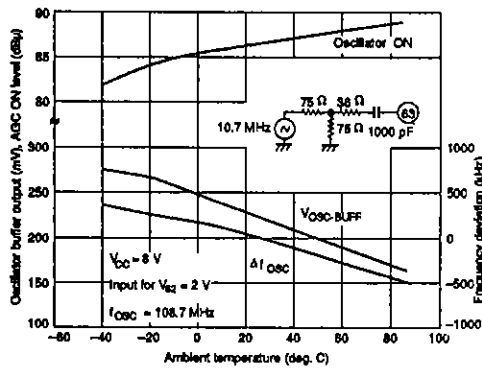

Oscillator output vs. -3 dB L.S. and QS

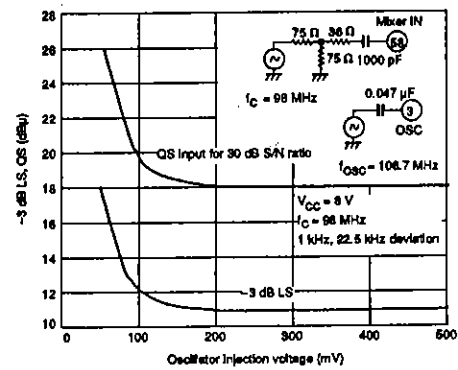

Two-signal characteristics (1)

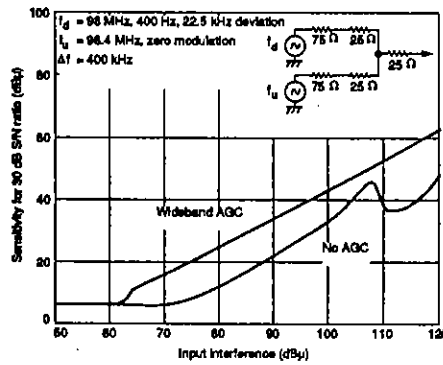

Muting attenuation vs. IF Input

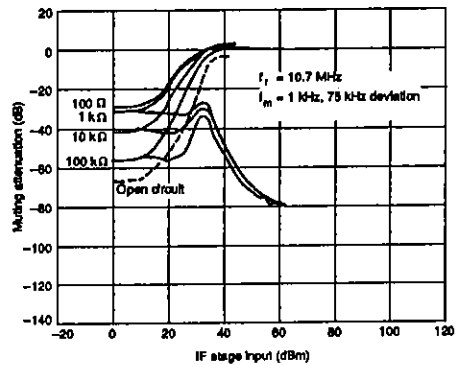

Two-signal characteristics (2)

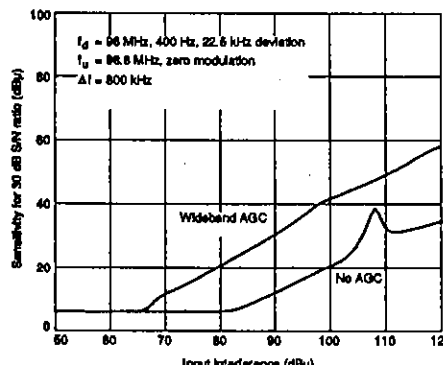

Mute ON level vs. IF Input

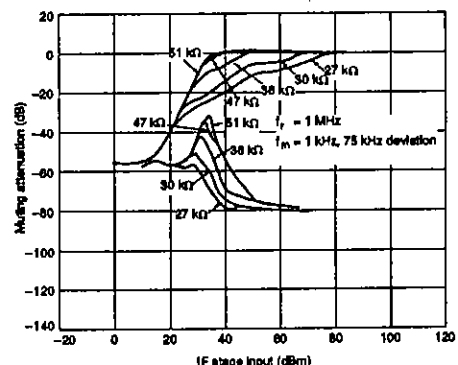

S-meter output and mute output vs. IF Input

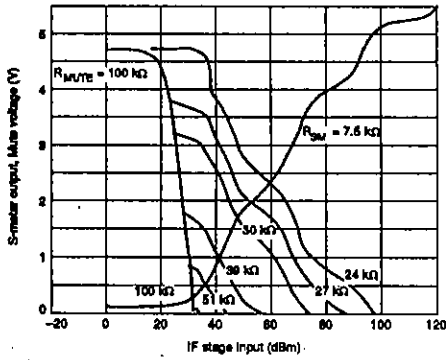

AM characteristics

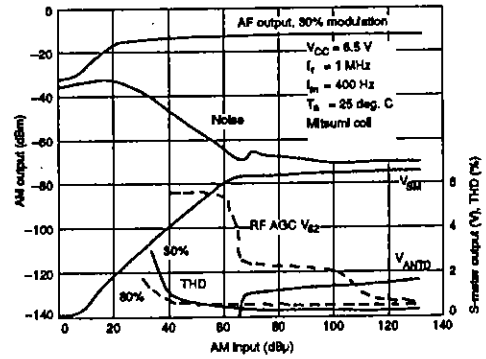

S-meter output and -3 dB L.S. vs. ambient temperature

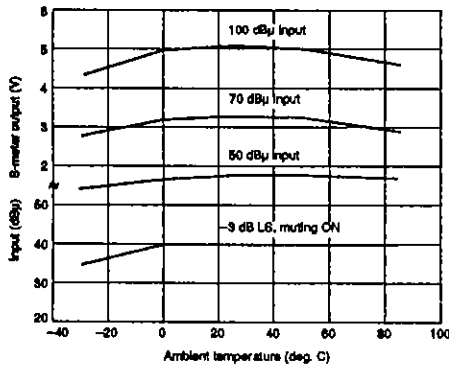

Mixer characteristics

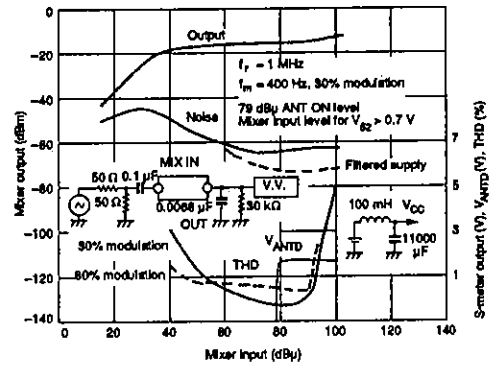

$V_{33}$  vs. ambient temperature

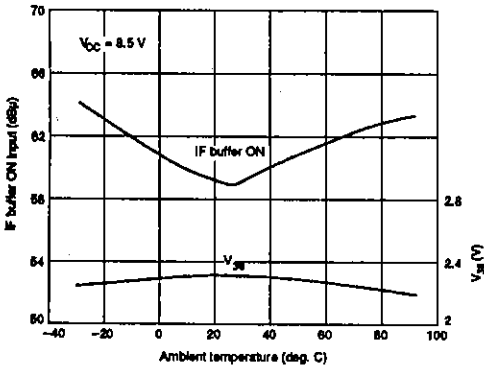

IF stage characteristics

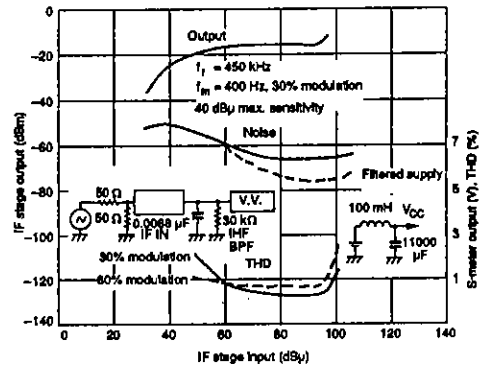

IF count buffer output vs. load capacitance

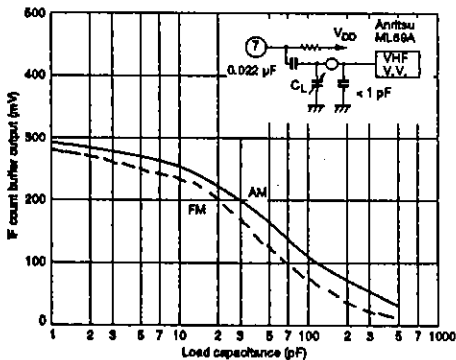

Detector characteristics

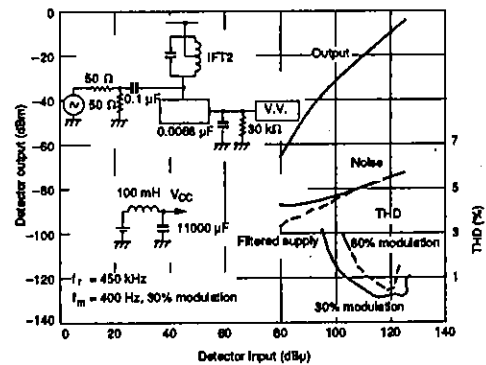

Detector output and THD vs. modulation

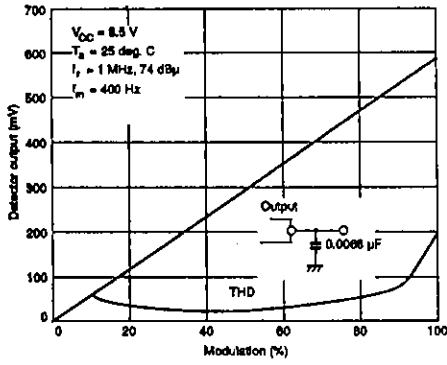

AM two-signal characteristics (1)

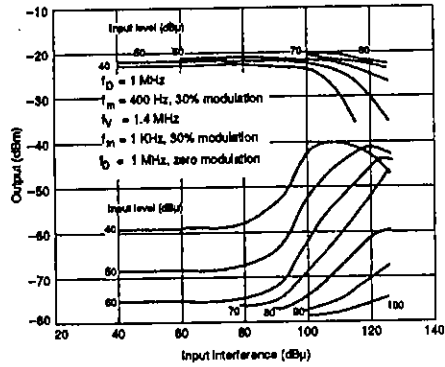

Fidelity characteristics

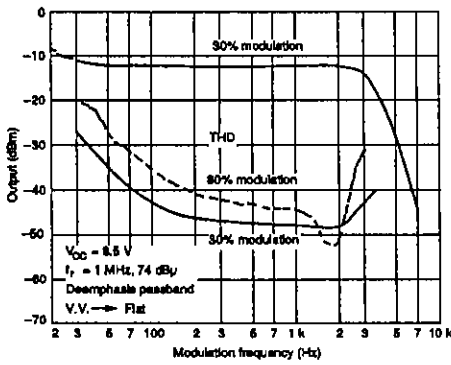

AM two-signal characteristics (2)

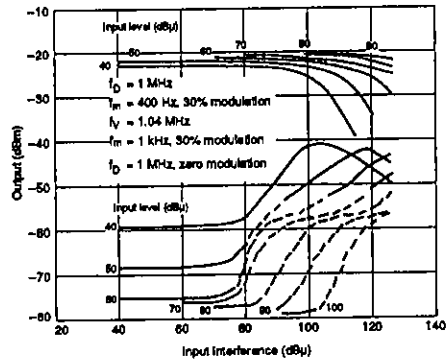

Second-harmonic beat noise prevention (1)

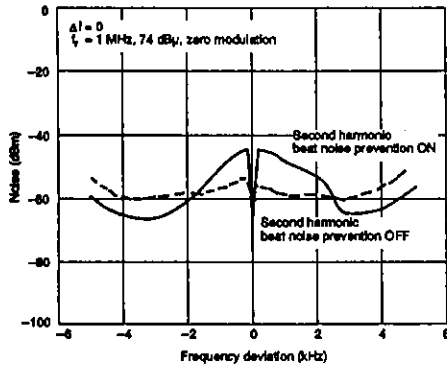

RF AGC frequency response

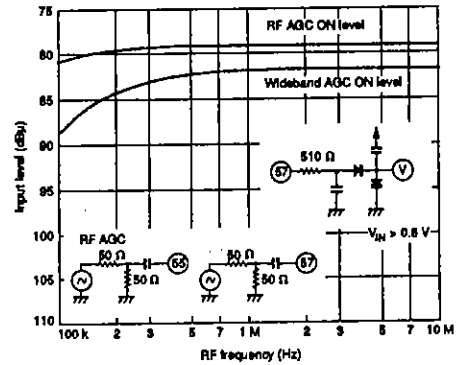

Second-harmonic beat noise prevention (2)

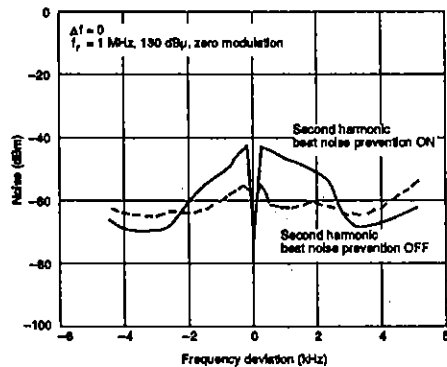

HCC/LCC and SNC characteristics

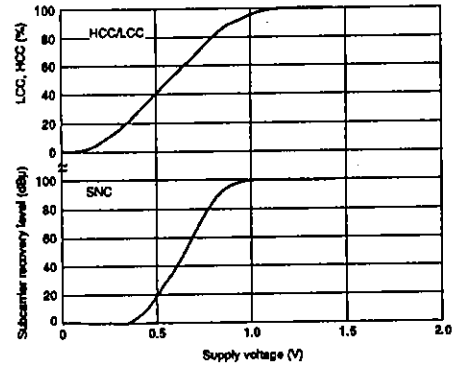

Low-pass filter frequency response (1)

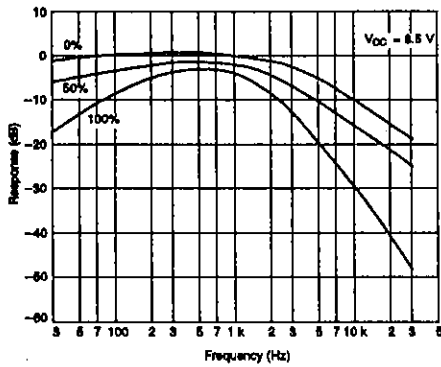

High-pass filter frequency response (stereo)

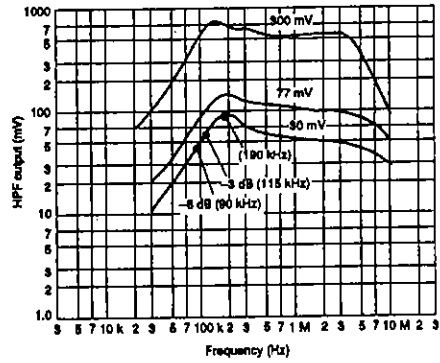

Low-pass filter frequency response (2)

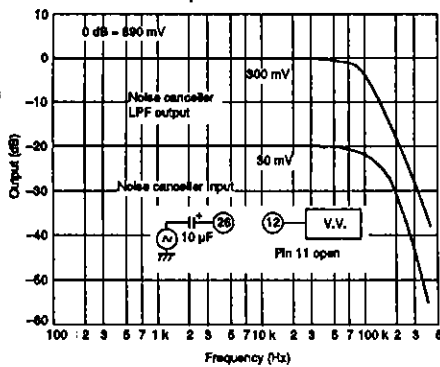

Pin 8 output vs. frequency (1)

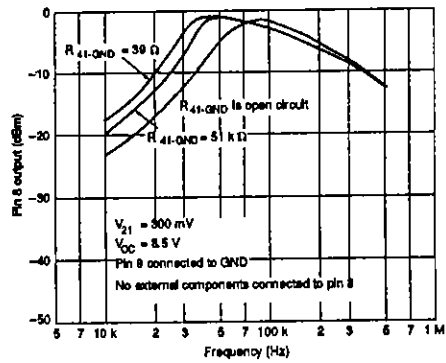

High-pass filter frequency response (mono)

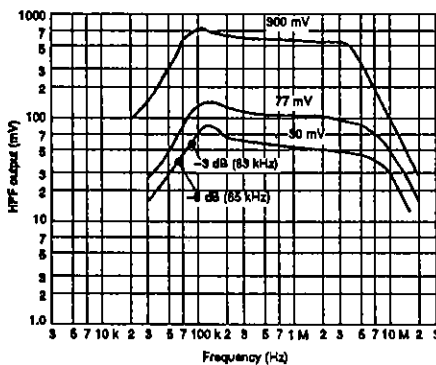

Pin 8 output vs. frequency (2)

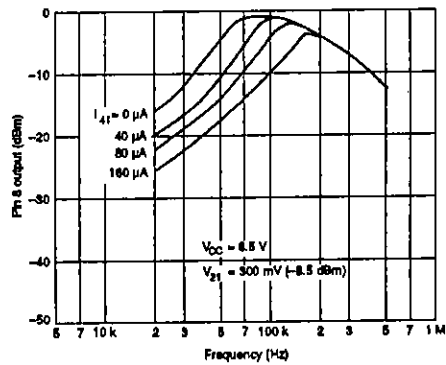

## FUNCTIONAL DESCRIPTION

### FM Front-end

#### AGC

The FM front-end AGC comprises two circuits—the pin-diode antenna input limiter and the dual-gate FET gain controller, shown in figure 1. The AGC ON level,

measured on pin 63, is determined by an external capacitor and is typically 20 mV.

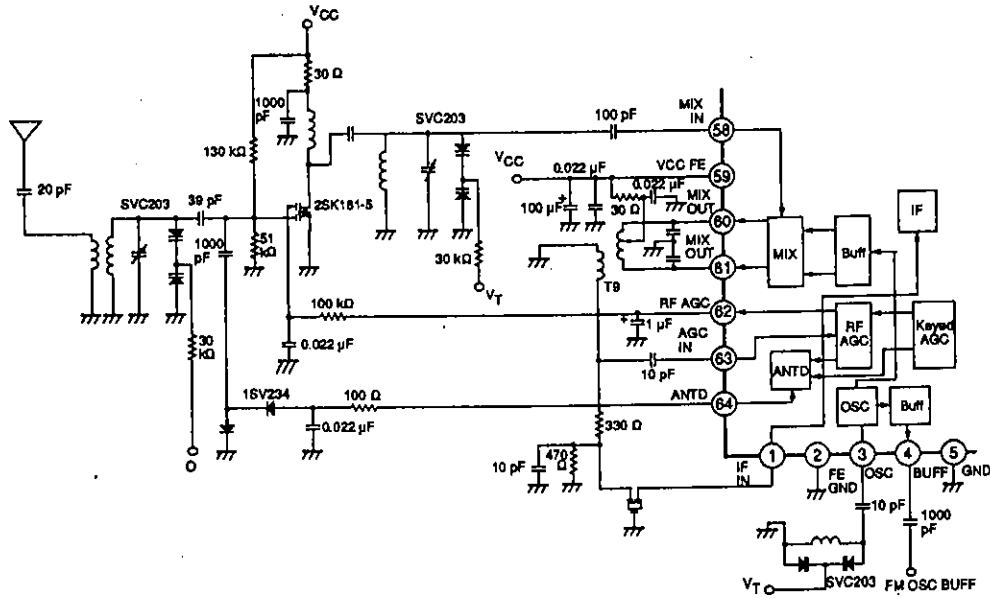

Figure 1. AGC stage

The pin-diode driver operates when the voltage on pin 62 is equal to or less than approximately  $(V_{CC} - 1)$  V. The impedance of the pin diode decreases as the current flowing through it increases. The voltage on the second gate of the FET also drops, decreasing the FET's transconductance,  $g_m$ . This attenuates the input signal by approximately 30 to 40 dB as shown in figure 2.

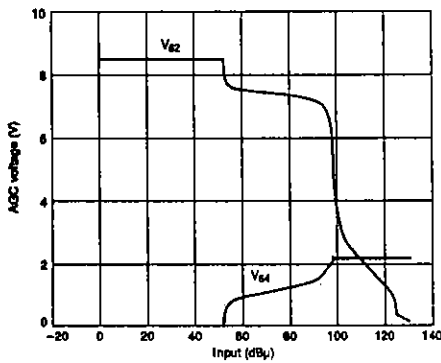

Figure 2. Input attenuation

The AGC input level is primarily determined by the mixer coil. A typical input level characteristic is shown in figure 3, and the AGC ON level frequency response, in figure 4.

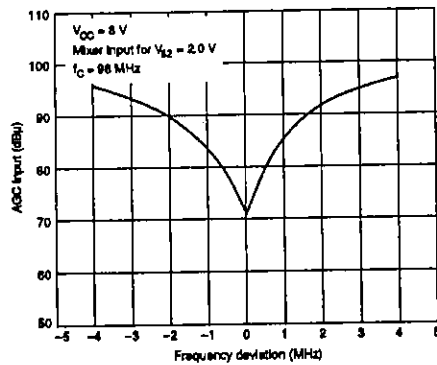

Figure 3. Input characteristic

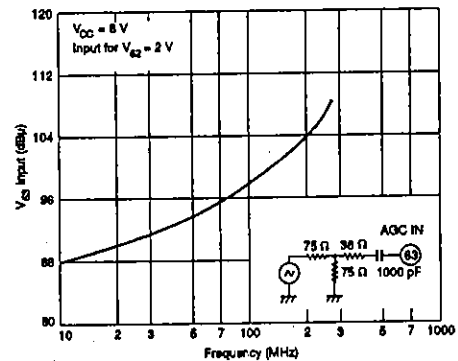

Figure 4. AGC frequency response

Note

The recommended FET is the 3SK181. Since this is an enhancement-mode MOSFET, full attenuation is achieved at a gate-source voltage of  $V_{G2-S} = 0$  V.



**Oscillator**

The oscillator is a Colpitts oscillator with an on-chip feedback network. The oscillator level is set by the padding capacitor and the Q of the components connected to the oscillator transistor base on pin 3. Mixer conversion and negative feedback is reliably achieved when the voltage on pin 3 is greater than 200 mV. Typical oscillator characteristics are shown in figure 5.

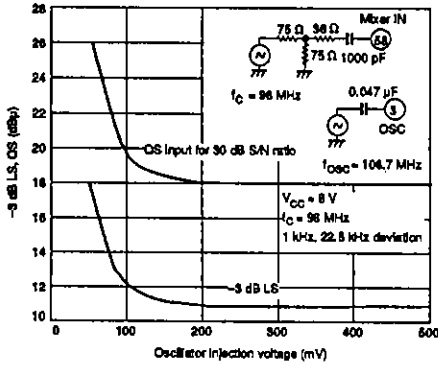

Figure 5. Mixer gain vs. oscillator output

The oscillator output is buffered by an emitter follower and output on pin 4. The external circuit shown in figure 6 can be used if there is insufficient output drive. Note that the collector current should be less than 5 mA.

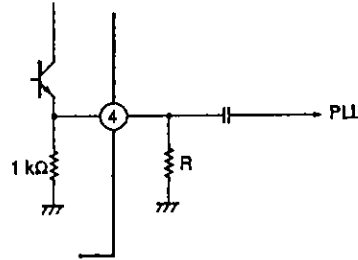

Figure 6. External circuit

**FM IF Stage**

The FM IF stage is shown in figure 7. The bypass capacitor connected to pin 43 improves weak-signal stability.

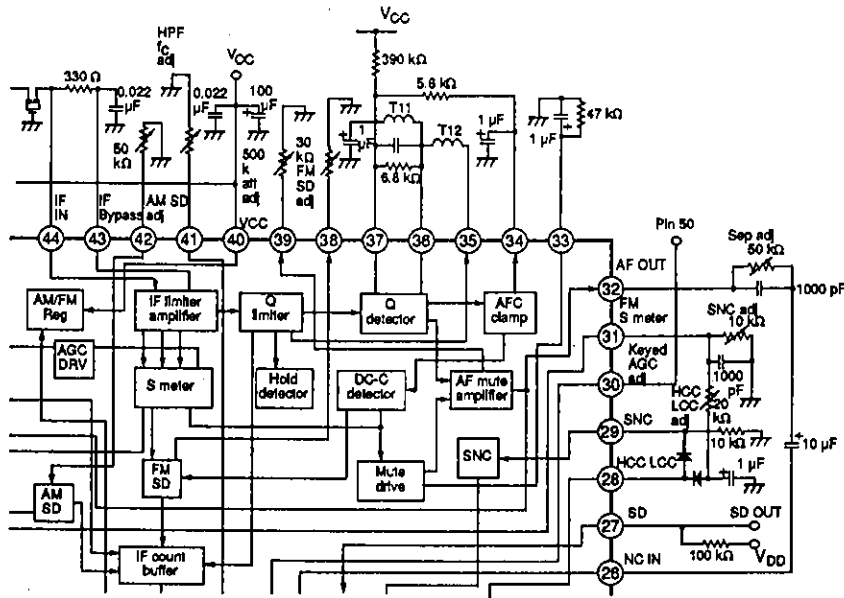

Figure 7. FM IF stage

**IF count buffer**

Station seek is selected when the voltage on pin 7 is V<sub>DD</sub> (5 V), and then when pin 7 is grounded, station seek halts. The voltage on this pin can be controlled externally by a microprocessor.

The 10.7 MHz IF count signal is output on pin 7 when band muting and weak-signal detection are both OFF

and the S-meter output voltage is greater than the voltage on pin 38. Otherwise, there is no output signal on pin 7. See figure 8. The signal detector output, pin 27, goes HIGH when the IF count buffer becomes active.

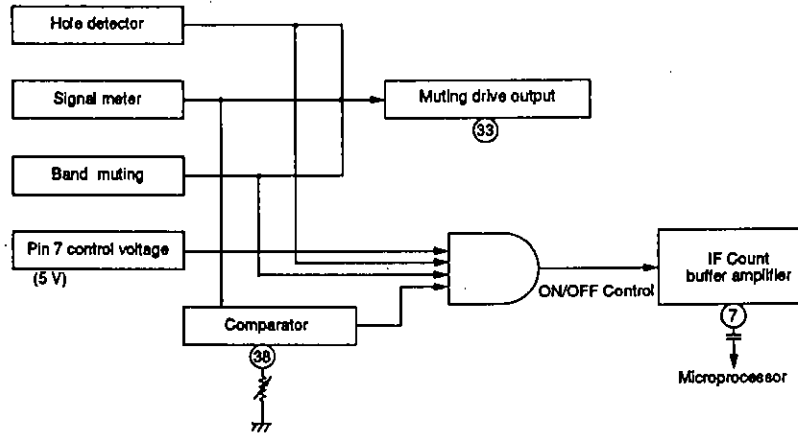

Figure 8. IF count buffer

**Station seek overshoot**

An excessive response time can delay the IF count buffer output causing station seek overshoot. This response time is dependent on the time constants of the circuits connected to the mute drive pin (pin 33), S-meter output (pin 50), FM signal detector adjustment pin (pin 38) and automatic frequency control pin (pin 34). The time constants for pins 33 and 34 are given in figures 9 and 10, respectively.

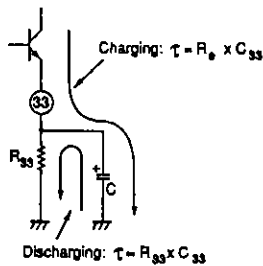

Figure 9. Mute drive time constant

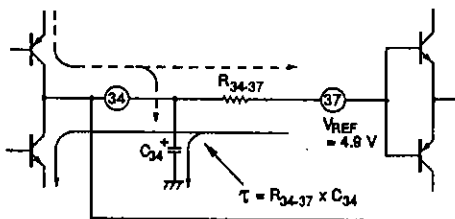

Figure 10. AFC input time constant

**Soft muting characteristic**

The soft muting attenuation and ON level are determined by variable resistors connected to pins 39 and 47. The general shape of the characteristics obtained by varying these resistors is shown in figure 11.

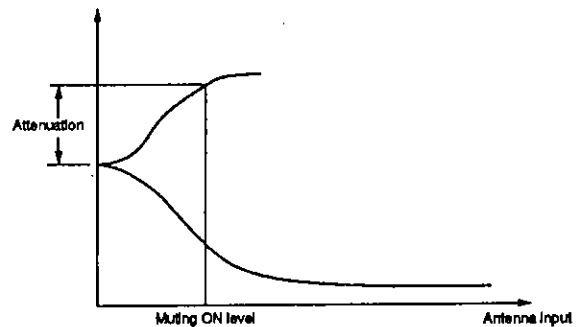

Figure 11. General shape of soft muting characteristic

The muting attenuation characteristics obtained by varying  $R_{39}$  while  $R_{47} = 51 \text{ k}\Omega$  are shown in figure 12.

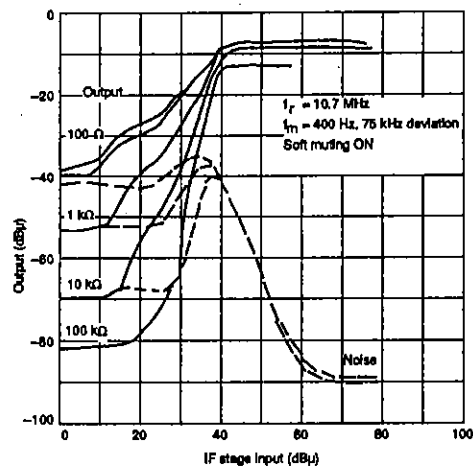

Figure 12. Muting attenuation characteristics

The muting ON level characteristics obtained by varying  $R_{47}$  while  $R_{39} = 10 \text{ k}\Omega$  are shown in figure 13.

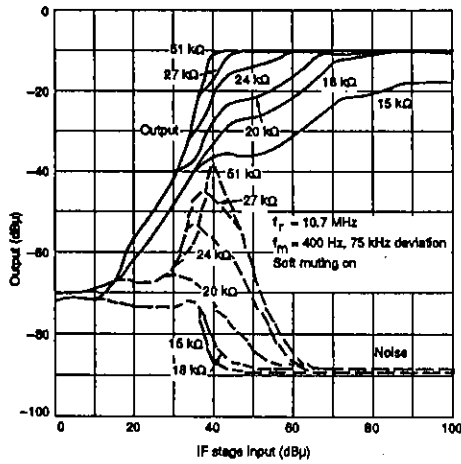

Figure 13. Muting ON level characteristics

The muting attenuation's resistor dependence is shown in figure 14.

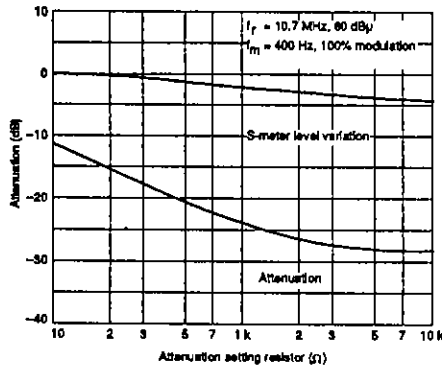

Figure 14. Muting attenuation's resistor dependence

**AFC bandwidth**

The AFC bandwidth is dependent on the load resistor between pins 34 and 37,  $R_{34-37}$ . This dependence is shown in figure 15.

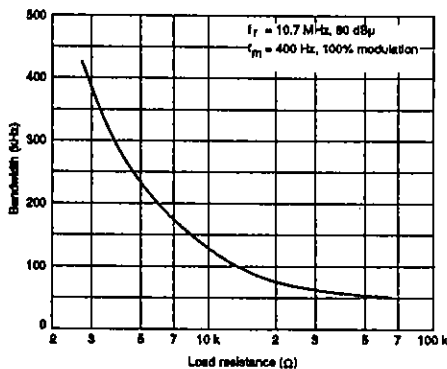

Figure 15. Bandwidth vs. load resistance

**Stop sensitivity**

The stop sensitivity is adjusted by varying the resistor connected to pin 38. See figure 16.

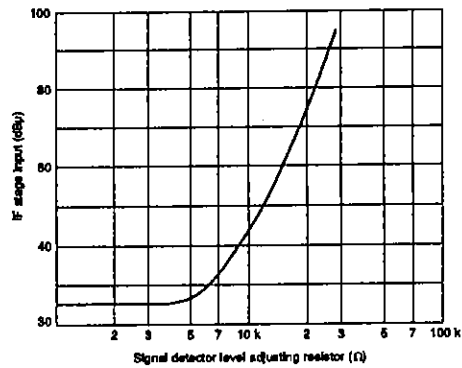

Figure 16. IF input vs.  $R_{SD de j}$

The antenna input level required to activate the IF count buffer for varying IF count buffer ON level setting resistances is shown in figure 17.

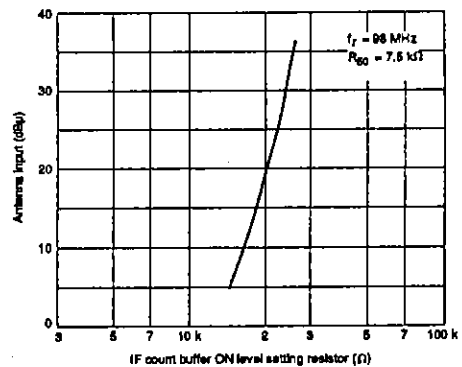

Figure 17. Antenna input vs. IF count buffer ON threshold resistance

**Note**

When testing the stop sensitivity, the IF count buffer output can become active if there are any feedback paths through measuring equipment to ground as shown in figure 18.

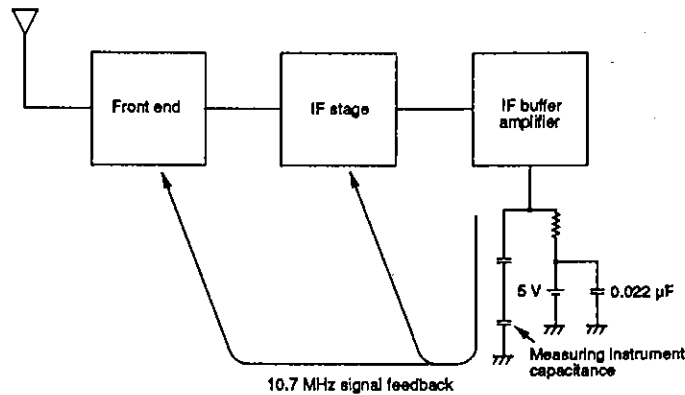

Figure 18. IF count feedback

**S-meter output**

The S-meter output (pin 50), whose equivalent circuit is shown in figure 19, is used in both AM and FM reception. It is switched internally for FM when pin 53 is HIGH (3.5 V or greater), and for AM when pin 53 is LOW (1.5 V or lower). In both AM and FM modes, the resistor connected to pin 50 determines the output voltage. The maximum output value is clamped to 7.0 V.

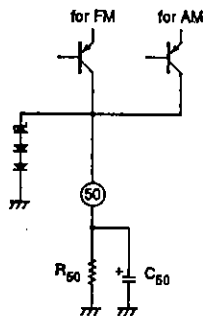

Figure 19. S-meter output

In FM mode, pin 50 is used to detect the field strength for station seek stop and the soft muting level. If any AC ripple voltage is present, the stability of these two functions is reduced.

**FM IF stage and AM tuner output Impedance**

Pin 32 is both the FM IF output and the AM tuner output. The output mode is selected by the voltage applied to AM/FM SW, pin 53. If the voltage on pin 53 is LOW (1.5 V or less), AM is selected, and if HIGH (3.5 V or more), FM is selected. The equivalent output circuit is shown in figure 20.

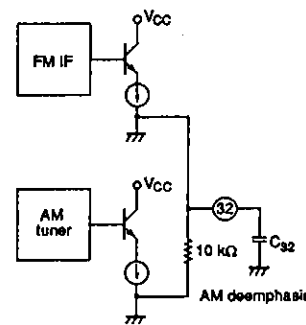

Figure 20. Equivalent output circuit

FM mono reception is selected when pin 6 is HIGH, and FM stereo, when pin 6 is LOW.

In FM stereo, subcarrier distortion is determined by the cutoff frequency,  $f_c$ , whose time constant is given by  $r_E \times C_{32}$ , where  $r_E$  is the FM IF stage output impedance and  $C_{32}$  is the AM deemphasis capacitor. In FM mono,  $C_{32}$  has no effect.

**AM Tuner**

**AGC**

The AM tuner RF AGC comprises two circuits—the mixer input level detector and the FET-input level detector.

The AM tuner stage and its typical characteristics are shown in figures 21 and 22, respectively.

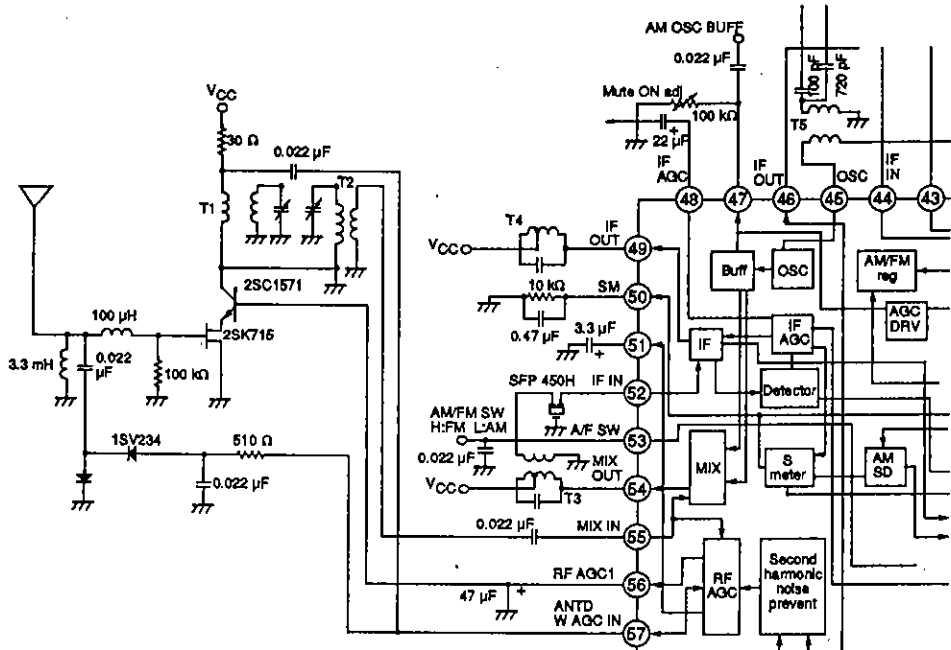

Figure 21. AGC stage

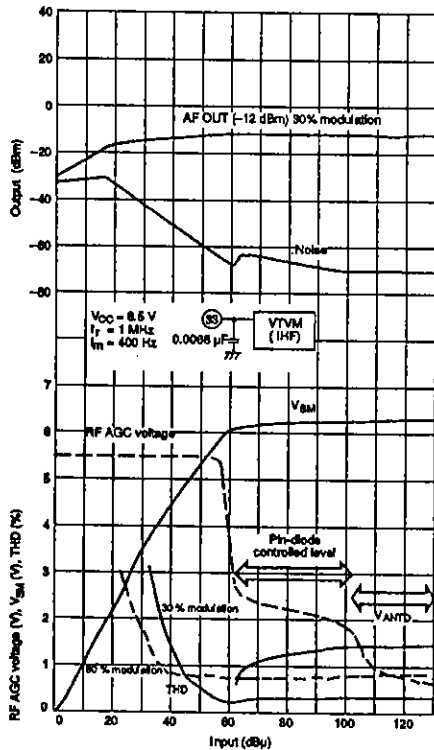

Figure 22. AM stage characteristics

The effect of both AGC circuits is shown in figure 23.

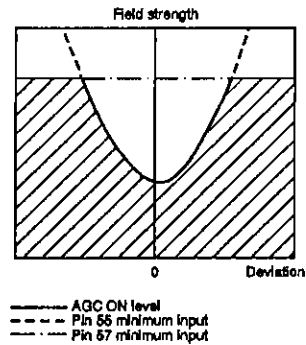

Figure 23. Wideband AGC and antenna input field strength

**Mixer Input AGC ON level**

This AGC circuit detects the signal level on pin 55 to maintain the mixer input dynamic range. Its ON level (the dashed line shown in figure 23) is set internally. It suppresses interference from adjacent stations within  $\pm 40$  kHz in the RF band. The signal level is maintained within the shaded area shown in figure 23. The mixer input AGC ON level can be increased by approximately 10 dB.

**Causes of second-harmonic beat noise**

The 900 kHz RF input signal from the antenna is amplified by the FET RF amplifier and passes through the alignment circuit to the mixer. If this signal is large, the varactor diodes can cause second-harmonic distortion of 1800 kHz. The 900 and 1800 kHz components each produce an IF signal— $(450 + \alpha)$  kHz for the 900



The AGC capacitors C<sub>51</sub> and C<sub>56</sub> determine the low-frequency modulation distortion. Distortion decreases if either capacitor is increased, however, this increases the response time.

**FET V<sub>DS</sub> control cascade transistor**

When there is no input signal, the voltage on pin 56 is given by the following equation, where h<sub>FE</sub> is the current gain of the cascade transistor. See figure 29.

$$V_{56} \cong 5.6 - 10000 \times \frac{I_{DSS}}{h_{FE}} \text{ V}$$

For increased stability, the cascade transistor should be a low-noise, high-h<sub>FE</sub> type.

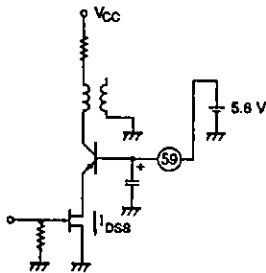

Figure 29. Cascade transistor

**Oscillator**

The oscillator can operate up into the short-wave band. However, the oscillator buffer operates only up into the medium-wave band. As a result, an external oscillator buffer is required for short-wave reception.

The oscillator has a 2 kΩ resistor in series with the base so that it is less susceptible to station seek error at low temperatures than previous devices. This problem is caused by parasitic oscillations in the 50 to 100 MHz region.

**Automatic station seek**

The automatic station seek system is shown in block form in figure 30.

**DESIGN NOTES**

**FM Front-end and IF Stage**

**AGC capacitors**

The AGC capacitors, C<sub>62</sub> and C<sub>64</sub>, can be increased to improve parameters such as AM rejection. However, the increased response time of the AGC can cause audio dropout. In particular, C<sub>62</sub>, which forms an RC network with the 12 kΩ output resistance, cannot be made too large. The recommended value of C<sub>62</sub> is 1 to 3.3 μF.

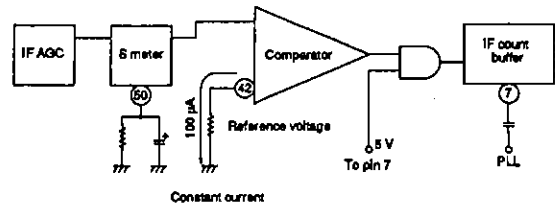

Figure 30. Station seek system

The IF count buffer is turned ON when the S-meter output voltage is greater than the reference voltage on pin 42, given by V<sub>42</sub> ≅ (100 × R<sub>42</sub>) μV, and pin 7 is HIGH. When pin 7 goes HIGH, the IF AGC time constant is reduced to approximately 50 × C<sub>49</sub>, reducing the S-meter response time during station seek. When station seek halts, pin 7 goes LOW turning the IF count buffer OFF. Linearity is approximately 60 dB until the RF AGC turns ON.

**AM level adjustment**

The AM output level is determined by the voltage divider formed by R<sub>32</sub> and the internal 10 kΩ resistor as shown in figure 31. The AM output level with no output load is 2 to 3 dB higher than the FM output level for the same modulation level.

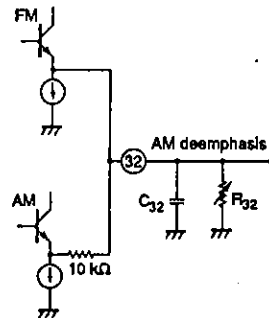

Figure 31. AM level

**Weak-signal stability and AM rejection**

The close proximity of the FM front-end and IF stages, and the narrow 0.8 mm pin pitch can cause ground and supply voltage interference. This can decrease the weak-signal stability and AM rejection. To prevent this problem, ensure that all ground lines for the RF stage, mixer and oscillator are isolated. Isolation of the oscillator supply ground is particularly important.

## QR coil design

The FM IF stage in the LA1886M is similar to the FM IF stage in the Sanyo LA1145. The design of the QR coil is identical to that for the LA1145.

## AM Tuner

### Alignment coil

The RF amplifier gain and the sensitivity are almost constant if the alignment stage has a flat frequency response. However, the alignment coil could have either loose, critical or tight coupling. At 1400 kHz, tight coupling can result in the tracking error shown in figure 32, with a resulting deterioration in the two-signal characteristic (two signals interfering at  $\pm 40$  kHz). The coil should be designed carefully to avoid this occurring.

The gain of the RF amplifier can be increased by increasing the number of turns on the primary coil. This method of gain adjustment has the fewest side effects.

## Multiplex Filter

The multiplex filter deemphasis time constant is determined by the external capacitors connected to pins 16 and 17. For  $0.015 \mu\text{F}$ , the time constant is  $50 \mu\text{s}$ , and for  $0.022 \mu\text{F}$ ,  $75 \mu\text{s}$ .

The multiplex filter high-frequency cutoff,  $f_c$ , is determined by the external resistor connected to pin 41. To increase  $f_c$ , connect the resistor to  $V_{CC}$ . To decrease  $f_c$ , connect the resistor to GND. The resistor should be between  $50$  and  $500 \text{ k}\Omega$ . If pin 41 is open circuit,  $f_c$  is approximately  $80 \text{ kHz}$ .

The recommended ceramic resonator, connected to pin 23, is the Murata CSB456F23.

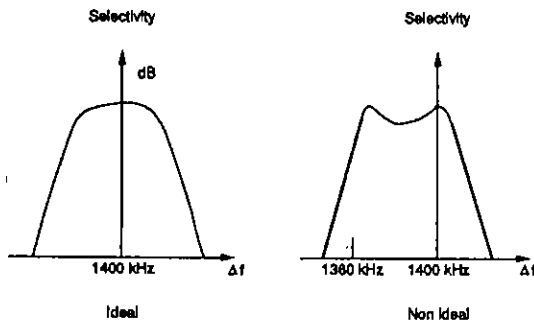

Figure 32. Tracking characteristic

- No products described or contained herein are intended for use in surgical implants, life-support systems, aerospace equipment, nuclear power control systems, vehicles, disaster/crime-prevention equipment and the like, the failure of which may directly or indirectly cause injury, death or property loss.
- Anyone purchasing any products described or contained herein for an above-mentioned use shall:
  - ① Accept full responsibility and indemnify and defend SANYO ELECTRIC CO., LTD., its affiliates, subsidiaries and distributors and all their officers and employees, jointly and severally, against any and all claims and litigation and all damages, cost and expenses associated with such use;
  - ② Not impose any responsibility for any fault or negligence which may be cited in any such claim or litigation on SANYO ELECTRIC CO., LTD., its affiliates, subsidiaries and distributors or any of their officers and employees jointly or severally.
- Information (including circuit diagrams and circuit parameters) herein is for example only; it is not guaranteed for volume production. SANYO believes information herein is accurate and reliable, but no guarantees are made or implied regarding its use or any infringements of intellectual property rights or other rights of third parties.