

CMOS 4-BIT MICROCONTROLLER

T-49-19-40
TMP47C221AF, TMP47C421AF

The 47C221A/421A is a high speed and high performance 4-bit single chip microcomputer based on the TLCS-47 CMOS series with LCD driver.

PART No.	ROM	RAM	PACKAGE	OTP	PIGGYBACK
TMP47C221AF	2048 x 8-bit	192 x 4-bit	QFP64	TMP47P421AF	TMP47C921AG
TMP47C421AF	4096 x 8-bit	256 x 4-bit			

FEATURES

- ◆ 4-bit single chip microcomputer
- ◆ Instruction execution time : 1.9 μ s (at 4.2MHz)
- ◆ 89 basic instructions
- ◆ Table look-up instructions
- ◆ Subroutine nesting : 15 levels max.
- ◆ 6 interrupt sources (External : 2, Internal : 4)
All sources have independent latches each, and multiple interrupt control is available.
- ◆ I/O port (28pins)
 - Input 2ports 5pins
 - I/O 6ports 23pins
- ◆ Interval Timer
- ◆ Two 12-bit Timer/Counters
Timer, event counter, and pulse width measurement mode
- ◆ Serial Interface with 4-bit buffer
External/internal clock, and leading/trailing edge shift mode
- ◆ LCD driver
 - LCD direct drive is available (Max. 12-digit display at 1/4 duty LCD)
 - 1/4, 1/3, 1/2 duties or static drive are programmably selectable.
- ◆ Hold function
Battery/Capacitor back-up
- ◆ Real Time Emulator : BM4721A + 8M4723A

QFP64

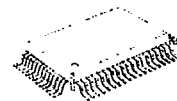

 TMP47C221AF
 TMP47C421AF
 TMP47P421AF

QFC64

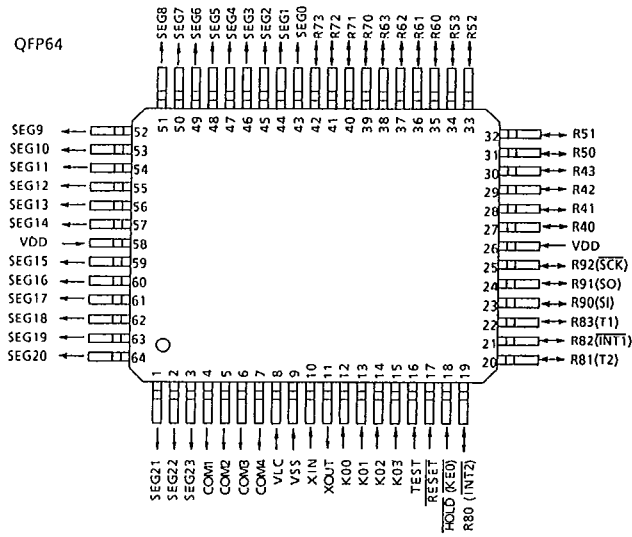

TMP47C921AG

PIN ASSIGNMENT (TOP VIEW)



BLOCK DIAGRAM

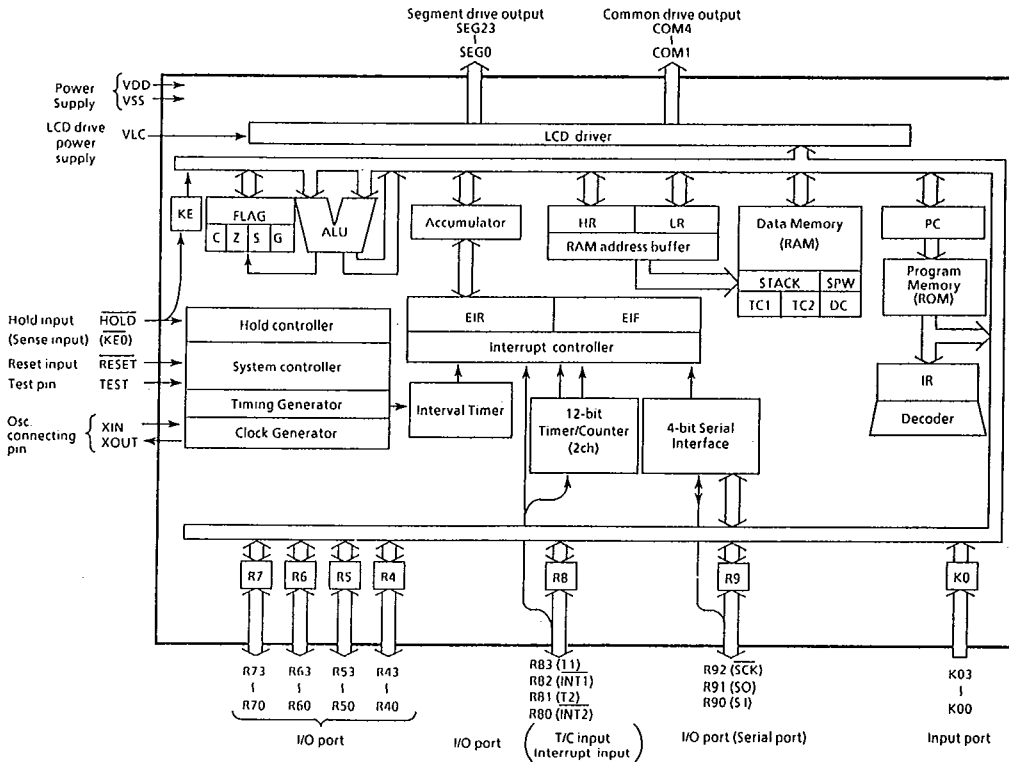

PIN FUNCTION

PIN NAME	Input/Output	FUNCTIONS		
K03 - K00	Input	4-bit input port		
R43 - R40	I/O	4-bit I/O port with latch.		
R53 - R50		When using as input port, the latch must be set to "1".		
R63 - R60		Every bit data is possible to be set, cleared and tested by the manipulation of the L-register indirect addressing.		
R73 - R70				
R83 (T1)	I/O (Input)	4-bit I/O port with latch.	Timer/Counter 1 external input	
R82 ($\overline{\text{INT}}1$)		When used as input port, external interrupt input pin, or Timer/Counter external input pin, the latch must be set to "1".	External interrupt 1 input	
R81 (T2)			Timer/Counter 2 external input	
R80 ($\overline{\text{INT}}2$)			External interrupt 2 input	
R92 (SCK)	I/O (I/O)	3-bit I/O port with latch.	Serial clock I/O	
R91 (SO)	I/O (Output)		When used as input port or serial port, the latch must be set to "1".	Serial data output
R90 (SI)	I/O (Input)			Serial data input
SEG23 - SEG0	Output	LCD Segment drive output		
COM4 - COM1		LCD Common drive output		
XIN	Input	Resonator connecting pin.		
XOUT	Output	For inputting external clock, XIN is used and XOUT is opened.		
$\overline{\text{RESET}}$	Input	Reset signal input		
HOLD ($\overline{\text{KE}}0$)	Input (Input)	Hold request/release signal input	Sense input	
TEST	Input	Test pin for out-going test. Be opened or fixed to low level.		
VDD	Power supply	+5V		
VSS		0V (GND)		
VLC		LCD drive power supply		

OPERATIONAL DESCRIPTION

Concerning the 47C221A/421A, the configuration and functions of hardwares are described. As the description has been provided with priority on those parts differing from the 47C200A/400A, the technical data sheets for the 47C200A/400A shall also be referred to.

1. SYSTEM CONFIGURATION

- (1) Program Memory (ROM)
- (2) Data Memory (RAM)
- (3) I/O port
- (4) Timer/Counters (TC1, TC2)
- (5) LCD Driver

2. INTERNAL CPU FUNCTION

2.1 Program Memory (ROM)

Program memory of the 47C221A/421A are similar to the 47C200A/400A except that the instruction [OUTB @HL] instruction and 5-bit to 8-bit data conversion table cannot be used.

2.2 Data Memory (RAM)

Data memory contained in the 47C221A has a 192×4 -bit (addresses 00-BF_H) capacity, and that contained in the 47C421A has a 256×4 -bit (addresses 00-FF_H) capacity.

There is no physical RAM in address C0-FF_H in the 47C221A.

Therefore, when addresses C0-FF_H are accessed on a program, RAM equivalent to address 80-BF_H is accessed.

The relationship between RAM capacity and addresses is shown in Figure 2-1.

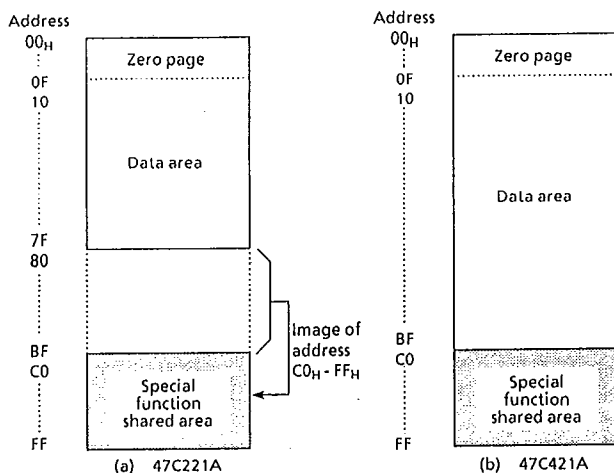

Figure 2-1. Data Memory Capacity and Address Assignment

3. PERIPHERAL HARDWARE FUNCTION

3.1 I/O port

The 47C221A/421A have 8 I/O ports (28pins) each as follows.

- ① K0 ; 4-bit input
- ② R4, R5, R6, R7 ; 4-bit input/output
- ③ R8 ; 4-bit input/output (shared by external interrupt input and Timer/Counter input)
- ④ R9 ; 3-bit input/output (shared by serial port)
- ⑤ KE ; 1-bit sense input (shared by hold request/release signal input)

For the 47C221A/421A, P1 and P2 ports are eliminated.

The operations and functions of other ports are similar to that of the 47C200A/400A.

Table 3-1 lists the port address assignments and the I/O instruction that can access the port. Further, the [OUTB @ HL] instruction and 5-bit to 8-bit data conversion table cannot be used.

Port address (**)	Port		Input/Output instruction					
	Input (IP**)	Output (OP**)	IN %p,A IN %p,@HL	OUTA,%p OUT@HL,%p	OUT #k,%p OUTB @HL	SET %p,b CLR %p,b TESTP %p,b	SET @L CLR @L TEST @L	
00H	K0 input port	_____	○	_____	_____	○	_____	
01	_____	_____	_____	_____	_____	_____	_____	
02	_____	_____	_____	_____	_____	_____	_____	
03	_____	_____	_____	_____	_____	_____	_____	
04	R4 input port	_____	○	_____	_____	○	_____	
05	R5 input port	_____	○	_____	_____	○	_____	
06	R6 input port	_____	○	_____	_____	○	_____	
07	R7 input port	_____	○	_____	_____	○	_____	
08	R8 input port	_____	○	_____	_____	○	_____	
09	R9 input port	_____	○	_____	_____	○	_____	
0A	_____	_____	_____	_____	_____	_____	_____	
0B	_____	_____	_____	_____	_____	_____	_____	
0C	_____	_____	_____	_____	_____	_____	_____	
0D	_____	_____	_____	_____	_____	_____	_____	
0E	SIO, HOLD status	_____	○	_____	_____	○	_____	
0F	Serial receive buffer	Serial transmit buffer	_____	_____	_____	_____	_____	
10H	Undefined	Hold operating mode control	_____	_____	_____	_____	_____	
11	Undefined	_____	_____	_____	_____	_____	_____	
12	Undefined	_____	_____	_____	_____	_____	_____	
13	Undefined	_____	_____	_____	_____	_____	_____	
14	Undefined	_____	_____	_____	_____	_____	_____	
15	Undefined	_____	_____	_____	_____	_____	_____	
16	Undefined	_____	_____	_____	_____	_____	_____	
17	Undefined	_____	_____	_____	_____	_____	_____	
18	Undefined	_____	_____	_____	_____	_____	_____	
19	Undefined	Interval timer control	_____	_____	_____	_____	_____	
1A	Undefined	LCD driver control 1	_____	_____	_____	_____	_____	
1B	Undefined	LCD driver control 2	_____	_____	_____	_____	_____	
1C	Undefined	Timer/Counter 1 control	_____	_____	_____	_____	_____	
1D	Undefined	Timer/Counter 2 control	_____	_____	_____	_____	_____	
1E	Undefined	_____	_____	_____	_____	_____	_____	
1F	Undefined	Serial interface control	_____	_____	_____	_____	_____	

Note. "_____" means the reserved state. Unavailable for the user programs.

Table 3-1. Port Address Assignments and Available I/O Instructions.

TOSHIBA

TMP47C221A/421A/921A

3.2 Timer/Counter (TC1, TC2)

The timer/counter of 47C221A/421A are similar to that of the 47C200A/400A except for the following point. The maximum frequency applied to the external input pin under the event counter mode is dependent upon the operating state of the LCD drive circuit.

Operating state of the LCD driver	Maximum frequency applied [Hz]			
	1-channel operation		2-channel operation	
	TC1	TC2	TC1	TC2
At time of blanking operation	$f_c / 32$		$f_c / 32$	$f_c / 40$
When LCD display is enabled	$f_c / 64$		$f_c / 72$	

Note. f_c ; Basic clock frequency

Table 3-2. The maximum frequency applied to the external input pin under the event counter mode.

3.3 LCD Driver

The 47C221A/421A have the circuit that directly drivers the liquid crystal display (LCD) and its control circuit.

The 42C221/421A have the following connecting pins with LCD.

- ① Segment output pins 24pins (SEG23-SEG0)
- ② Common output pins 4pins (COM4-COM1)

In addition, VLC pin is provided as the driver power.

The devices that can be directly driven is selectable from LCD of following drive methods.

- ① 1/4 duty (1/3 bias) LCD Max. 96 segments (8 segments x 12digits)
- ② 1/3 duty (1/3 bias) LCD Max. 72 segments (8 segments x 9digits)
- ③ 1/2 duty (1/2 bias) LCD Max. 48 segments (8 segments x 6digits)
- ④ Static LCD Max. 24 segments (8 segments x 3digits)

3.3.1 Configuration of LCD driver

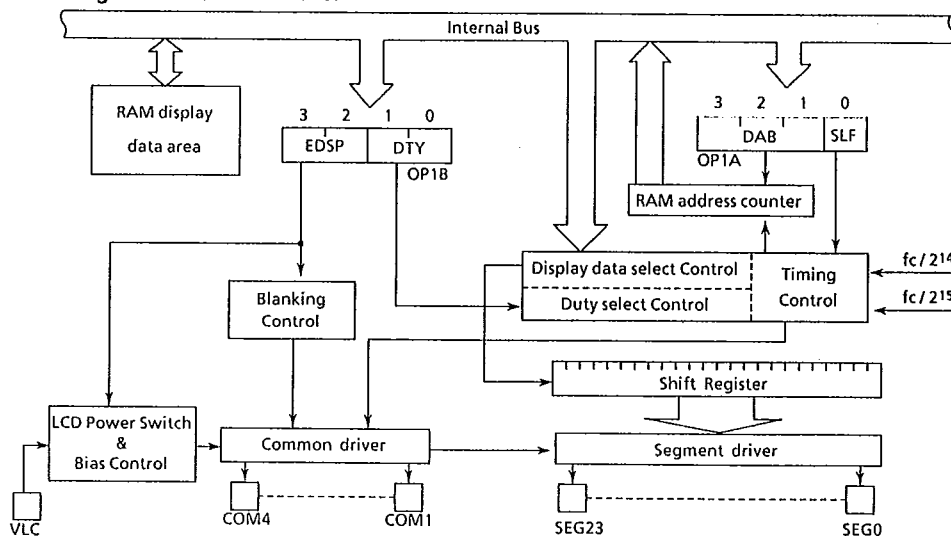

Figure 3-1. Configuration of LCD driver

TOSHIBA

TMP47C221A/421A/921A

3.3.2 Control of LCD driver

The LCD driver is controlled by the command register 1, 2 (OP1A, OP1B).

Note that, the MSB of the command register 2 must be cleared to "0" (set to blanking or designation of driving method) during accessing the command register 1.

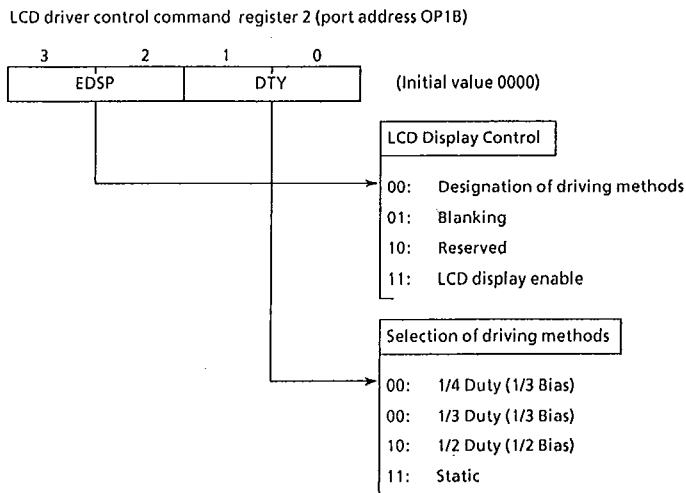
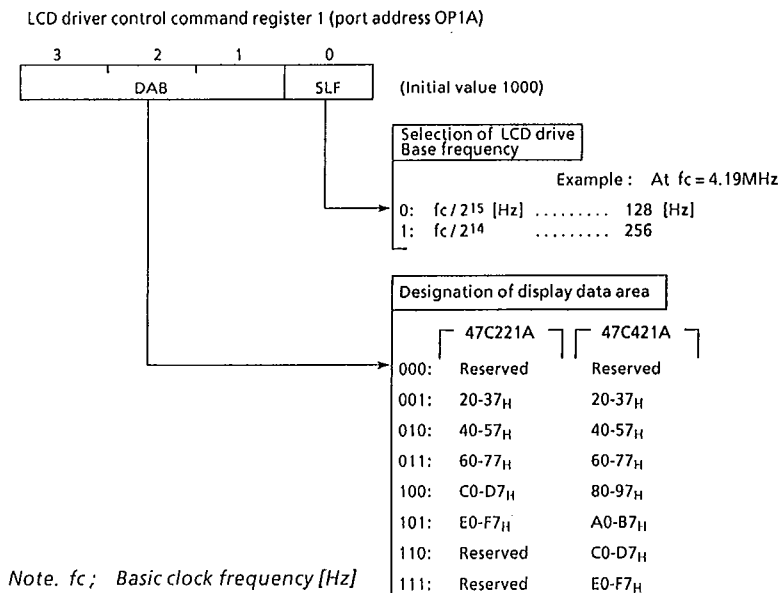

Figure 3-2. LCD driver control command register

TOSHIBA

TMP47C221A/421A/921A

(1) Driving methods of LCD driver

4 kinds of driving methods can be selected by DTY (bits 1 and 0 of command register). Figure 3-3 shows driving waveforms for LCD.

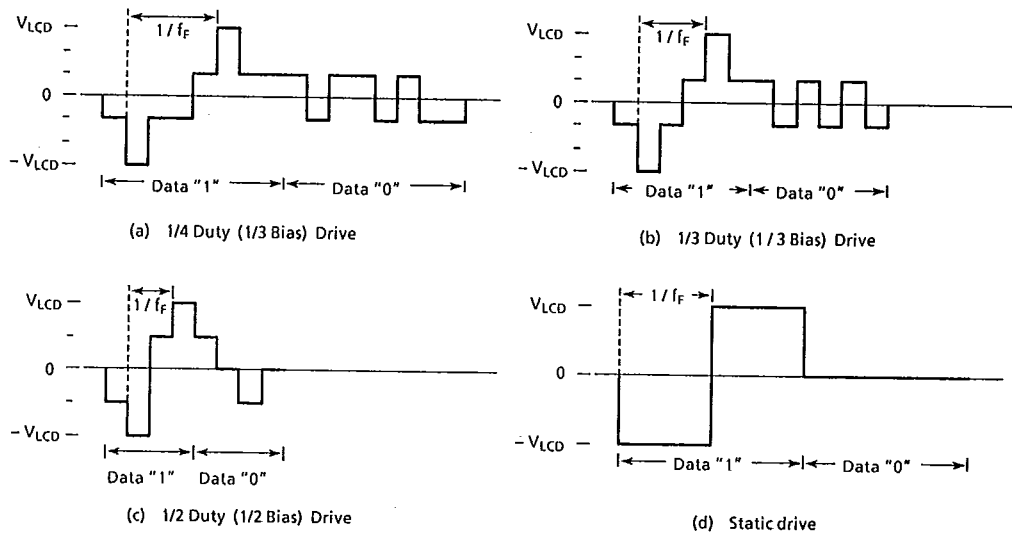

Note. f_F ; LCD Frame frequency V_{LCD} ; LCD drive voltage ($=V_{DD}-V_{LC}$)

Figure 3-3. LCD drive waveform (Voltage COM-SEG Pins)

(2) Frame frequency

Frame frequency is set according to the drive method and base frequency as shown in the following table 3-3.

It is possible to select base frequency (either one of 2 kind frequencies obtained from the driver) by SLF (bit 0 of command register 1).

Driving methods Base frequency	Frame Frequency [Hz]			
	1/4 Duty	1/3 Duty	1/2 Duty	Static
$\frac{f_c}{2^{15}}$	$\frac{f_c}{2^{15}}$	$\frac{4}{3} \cdot \frac{f_c}{2^{15}}$	$\frac{4}{2} \cdot \frac{f_c}{2^{15}}$	$\frac{f_c}{2^{15}}$
Ex. at $f_c = 4.19\text{MHz}$	128	171	256	128
$\frac{f_c}{2^{14}}$	$\frac{f_c}{2^{14}}$	$\frac{4}{3} \cdot \frac{f_c}{2^{14}}$	$\frac{4}{2} \cdot \frac{f_c}{2^{14}}$	$\frac{f_c}{2^{14}}$
Ex. at $f_c = 2.10\text{MHz}$	128	171	256	128

Note. f_c ; Basic clock frequency [Hz]

Table 3-3. Setting of LCD frame frequency

TOSHIBA

TMP47C221A/421A/921A

(3) LCD drive voltage

The LCD drive voltage (V_{LCD}) is given by the difference in potential ($V_{DD} - VLC$) between pins VDD and VLC. Therefore, when the CPU operating voltage and LCD drive voltage are the same, the VLC pin is connected to the VSS pin.

The LCD light only when the difference in potential between the segment output and common output is $\pm V_{LCD}$, and turn off at all other times.

During reset, the power switch of the LCD driver is turned off automatically, shutting off the VLC voltage.

Both the segment output and common output become V_{DD} level at this time and the LCD turn off.

The power switch is turned on to supply VLC voltage to the LCD driver by setting EDSP (bits 2 and 3 of the command register 2) to "11_B". After that, the power switch will not turn off even during blanking (setting EDSP to "01_B") and the VLC voltage continues to flow.

The power switch is turned off during hold operation low power consumption by turning off the LCD. When hold operation is released the status in effect immediately before the hold operation is reinstated.

3.3.3 LCD display operation

(1) Display data setting

Display data are stored to the display data area (Max.24 words) in the data memory.

The display data area is set using DAB (bits 1 to 3 of command register 1). During reset, the display data area is set to addresses C0-D7_H (47C221A) and 80-97_H (47C421A).

The display data stored to the display data area are read automatically and sent to the LCD driver by the hardware.

The LCD driver generates the segment signals and common signals in accordance with the display data and drive methods. Therefore, display patterns can be changed by only overwriting the contents of the display data area with a program. The table look-up instruction is mainly used for this overwriting. Figure 3-4 shows the correspondence between the display data area and the SEG/COM pins. The LCD light when the display data is "1" and turn off when "0".

The number of segment which can

be driven differs depending on the LCD drive method, therefore, the number of display data area bits used to store the data also differs (Refer to Table 3-4). Consequently, data memory not used to store display data and data memory for which the addresses are not connected to LCD can be used to store ordinary user's processing data.

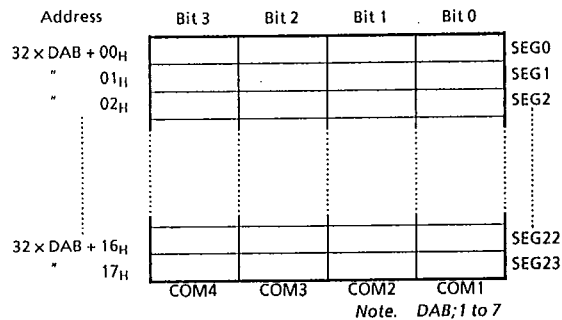

Figure 3-4. The correspondence between the display data area and the SEG/COM pins

drive methods	Bit 3	Bit 2	Bit 1	Bit 0
1/4Duty	COM4	COM3	COM2	COM1
1/3Duty	-	COM3	COM2	COM1
1/2Duty	-	-	COM2	COM1
Static	-	-	-	COM1

Note. - ; The data memory bits that are not used for storing display data

Table 3-4. The data memory bits that are used for driving method and storing display data.

TOSHIBA

TMP47C221A/421A/921A

(2) Transfer of display data

The display data stored to the display data area are automatically transferred to the LCD driver. The processing is performed in the following sequence.

- ① The LCD driver issues a display data send request to the CPU
- ② When the instruction (or Timer/Counter processing, interrupt receive processing) currently being executed is completed, the CPU reads out the data for one cycle and sends it to the LCD driver.

The data sending cycle is generated when the VLC voltage is being applied to the LCD driver. That is, after reset is canceled, it is not generated until EDSP is set to "11B". Table 3-5 shows the data sending cycle generation frequency.

When LCD display is enabled, the virtual instruction execution speed drops. For example, when SLF=0 and using 1/4 duty drive, this would be 2.05 μ sec, for an instruction execution speed of 2 μ sec.

SLF	Driving method	Frequency of data sending cycle insertion
0	Static drive	24 times in 4,096 instruction cycles
	Except Static drive	24 times in 1,024 instruction cycles
1	Static drive	24 times in 2,048 instruction cycles
	Except Static drive	24 times in 512 instruction cycles

Table 3-5. Frequency of data sending cycle insertion

(3) Blanking

Blanking is applied by setting EDSP to "01B" and turns off the LCD by outputting non light operation level to the COM pin.

The SEG pin continuously outputs the signal level in accordance with the display data and drive method. With static drive, no voltage is applied between the COM and SEG pins when the LCD is turned off by data (display data cleared to "0"), but the COM pin output becomes constant at the $V_{LCD}/2$ level when turning off the LCD by blanking, so the COM and SEG pins are then driven by $V_{LCD}/2$.

3.3.4 Control method of LCD driver

(1) Initial setting

Flow chart of initial setting is shown Figure 3-5.

Example: When operating the 47C421A with 1/4 duty LCD using a frame frequency of $fc/2^{15}$ [Hz] (display data area at addresses 80-97H).

```

LD      A, #0000B; Sets the 1/4 duty drive.
OUT     A, %OP1B
LD      A, #1000B; Setting of base frequency.
OUT     A, %OP1A ; Setting of display area in the
           memory.
:
:      Setting of clear or initial value of
           display area in the memory.
LD      A, #1100B; Display enable (Release of
           blanking)
OUT     A, %OP1B
:

```

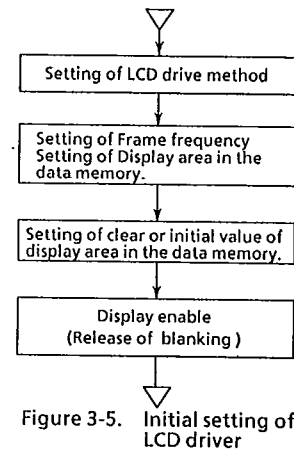

Figure 3-5. Initial setting of LCD driver

TOSHIBA

TMP47C221A/421A/921A

(2) Display data setting

Normally, display data are kept permanently in the program memory and are then stored to the display data area by the table look up instruction.

This can be explained using numerical display with 1/4 duty LCD as an example. The COM and SEG connections to the LCD are the same as those shown in Figure 3-6, and the display, data are as shown in Table 3-6. Programming example for displaying numerals corresponding to BCD data stored at address 10_H in the data memory is shown below. the display data area is at addresses 20-23_H.

```
LD    HL, #0FCH      ;To set the DC
LD    A, 10H
ST    A, @HL+
ST    #DTBL/16, @HL+
ST    #DTBL/256, @HL+
LD    HL, #20H      ;Display of data corresponding
LDL   A, @DC
ST    A, @HL+
LDH   A, @DC+
ST    A, @HL+
:
DTBL: DATA 1101111B, 00000110B, 11100011B, 10100111B, 00110110B,
           10110101B, 11110101B, 00010111B, 11110111B, 10110111B
```

Nu- meral	Display	Display data memory		Nu- meral	Display	Display data memory	
		Upper	Lower			Upper	Lower
0	0.	1101	1111	5	5	1011	0101
1	1	0000	0110	6	6	1111	0101
2	2	1110	0011	7	7	0001	0111
3	3	1010	0111	8	8	1111	0111
4	4	0011	0110	9	9	1011	0111

Table 3-6. Examples of Display Data (1/4 Duty LCD)

TOSHIBA

TMP47C221A/421A/921A

Table 3-7 shows the same numerical display used in Table 3-6, but using 1/2 duty LCD are the same as those shown in Figure 3-8.

Programming example for displaying numerals corresponding to BCD data stored at address 10H in the data memory is shown below. The display data area is at addresses 20-23H.

```

LD      HL, #0FCH      ; To set the DC
LD      A, 10H
ST      A, @HL+
ST      #DTBL/16, @HL+
ST      #DTBL/256, @HL+
LD      HL, #20H      ; Display of data corresponding
LDL     A, @DC
ST      A, @HL+
RORC   A
RORC   A
ST      A, @HL+
LDH    A, @DC+
ST      A, @HL+
RORC   A
RORC   A
ST      A, @HL+
:
DTBL: DATA 01110111B, 00100010B, 10010111B, 10100111B, 11100010B,
            11100101B, 11110101B, 01100011B, 11110111B, 11100111B

```

Nu- meral	Display data memory				Nu- meral	Display data memory			
	Upper		Lower			Upper		Lower	
0	**01	**11	**01	**11	5	**11	**10	**01	**01
1	**00	**10	**00	**10	6	**11	**11	**01	**01
2	**10	**01	**01	**11	7	**01	**10	**00	**11
3	**10	**10	**01	**11	8	**11	**11	**01	**11
4	**11	**10	**00	**10	9	**11	**10	**01	**11

Note. * ; don't care

Table 3-7. Example of Display Data (1/2 duty LCD)

TOSHIBA

TMP47C221A/421A/921A

(3) Example of drive output

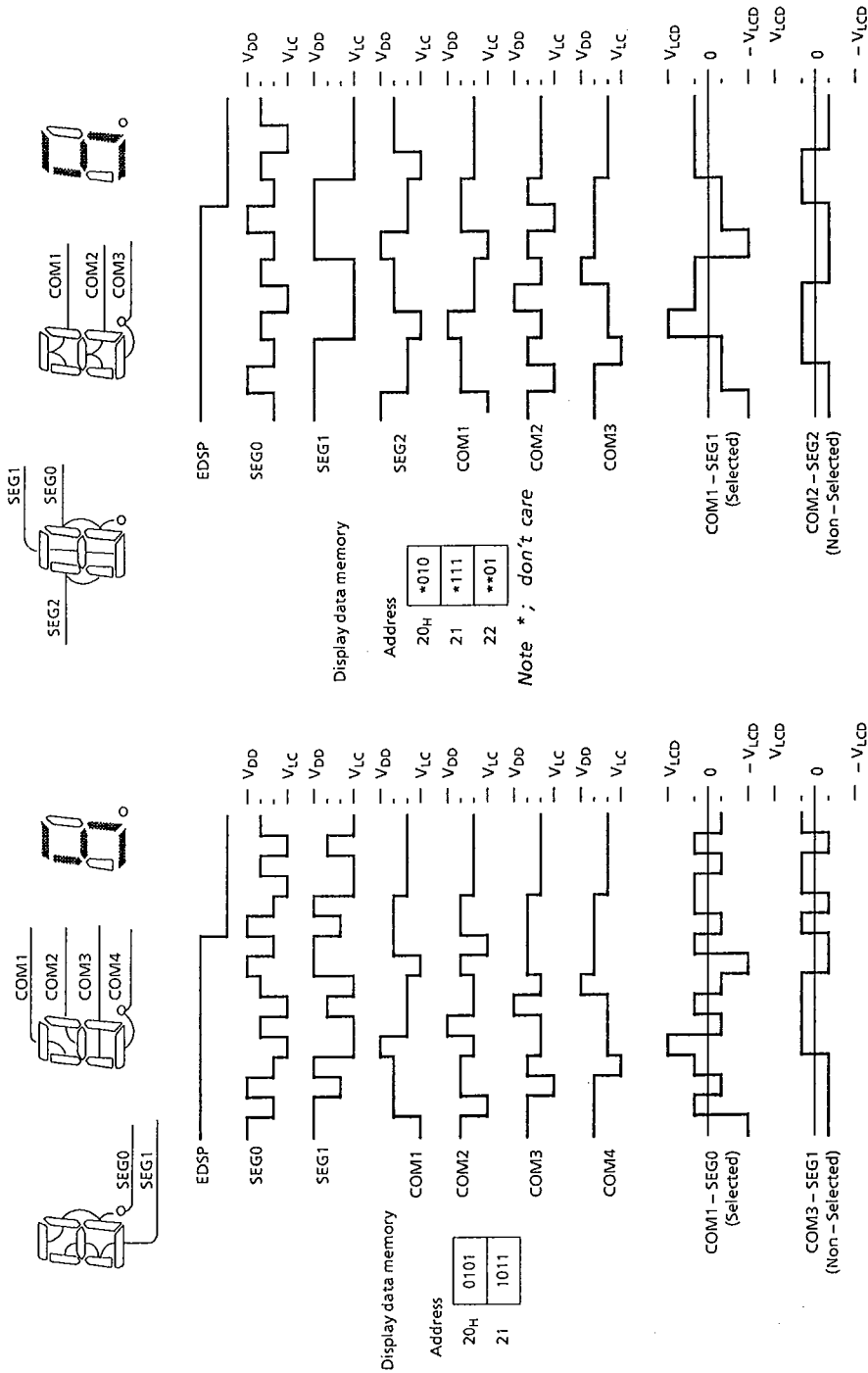

Figure 3-7. 1/3Duty (1/3Bias) Drive

Figure 3-6. 1/4Duty (1/3Bias) Drive

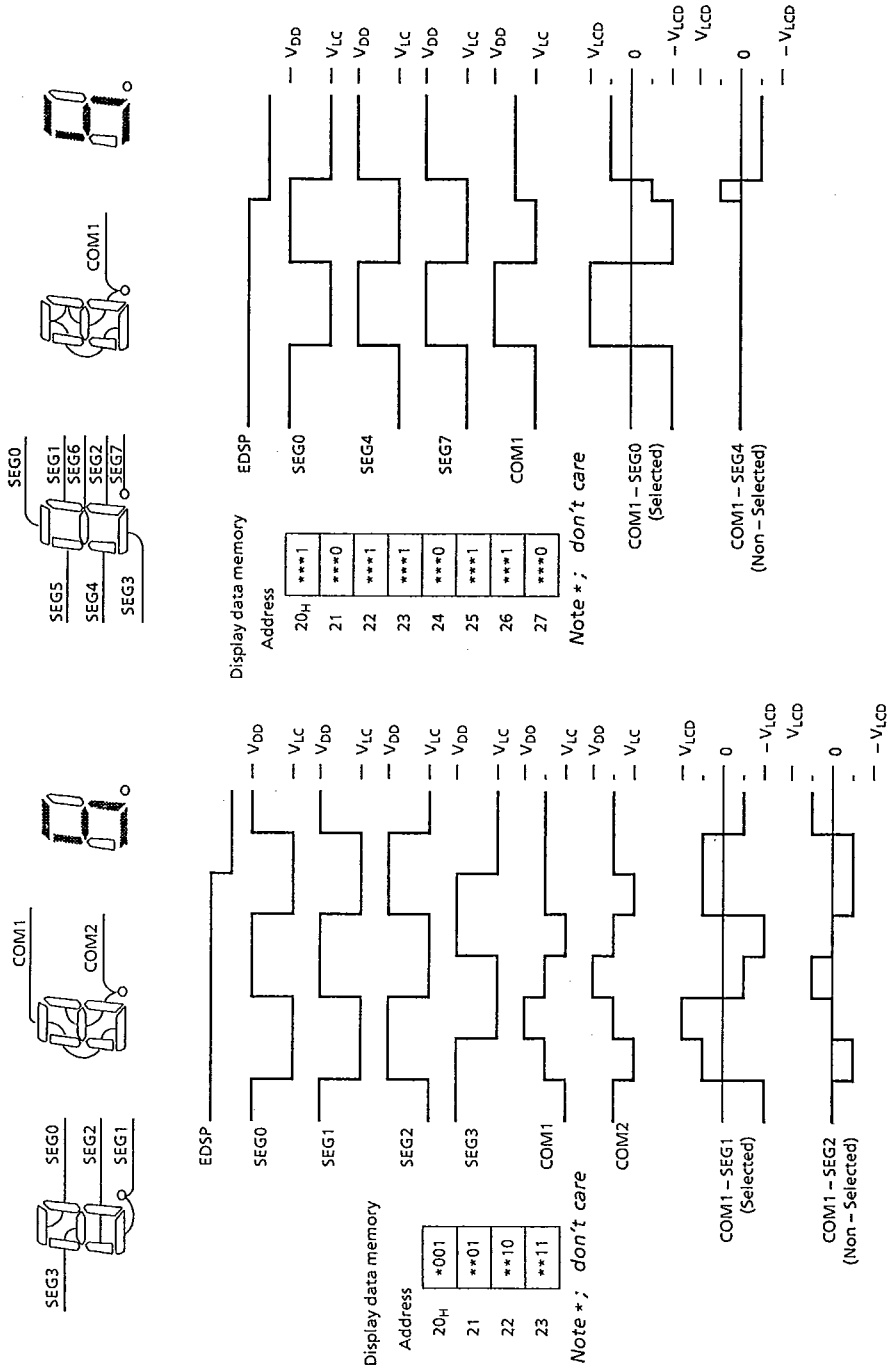

Figure 3-9. Static Drive

Figure 3-8. 1/2 Duty (1 / 2Bias) Drive

TOSHIBA

TMP47C221A/421A/921A

ELECTRICAL CHARACTERISTICS

ABSOLUTE MAXIMUM RATINGS ($V_{SS} = 0V$)

PARAMETER	SYMBOL	PINS	RATING	UNIT
Supply Voltage	V_{DD}		-0.5 to 7	V
Supply Voltage (LCD drive)	V_{LC}		-0.5 to $V_{DD} + 0.5$	V
Input Voltage	V_{IN}		-0.5 to $V_{DD} + 0.5$	V
Output Voltage	V_{OUT1}	Except sink open drain pin	-0.5 to $V_{DD} + 0.5$	V
	V_{OUT2}	Sink open drain pin	-0.5 to 10	
Output Current (per 1 pin)	I_{OUT}		3.2	mA
Power Dissipation [$T_{opr} = 70^\circ C$]	PD		400	mW
Soldering Temperature (time)	T_{sld}		260 (10sec)	$^\circ C$
Storage Temperature	T_{stg}		-55 to 125	$^\circ C$
Operating Temperature	T_{opr}		-30 to 60	$^\circ C$

RECOMMENDED OPERATING CONDITIONS ($V_{SS} = 0V$, $T_{opr} = -30$ to $70^\circ C$)

PARAMETER	SYMBOL	PINS	CONDITIONS	Min.	Max.	UNIT
Supply Voltage	V_{DD}		In the Normal operating mode	4.5	6.0	V
			In the Hold operating mode	2.0		
Input High Voltage	V_{IH1}	Except Hysteresis Input	$V_{DD} \geq 4.5V$	$V_{DD} \times 0.7$	V_{DD}	V
	V_{IH2}	Hysteresis Input		$V_{DD} \times 0.75$		
	V_{IH3}		$V_{DD} < 4.5V$	$V_{DD} \times 0.9$		
Input Low Voltage	V_{IL1}	Except Hysteresis Input	$V_{DD} \geq 4.5V$	0	$V_{DD} \times 0.3$	V
	V_{IL2}	Hysteresis Input			$V_{DD} \times 0.25$	
	V_{IL3}		$V_{DD} < 4.5V$		$V_{DD} \times 0.1$	
Clock Frequency	f_c			0.4	4.2	MHz

Note 1. Input Voltage V_{IH3} , V_{IL3} : in the HOLD operating mode.

Note 2. 1MHz is recommended as minimum frequency when $SLF = 1$. And 2MHz is when $SLF = 0$.

TOSHIBA

TMP47C221A/421A/921A

D.C. CHARACTERISTICS

 $(V_{SS} = 0V, V_{DD} = 4.5 \text{ to } 6.0V, T_{opr} = -30 \text{ to } 70^{\circ}C)$

PARAMETER	SYMBOL	PINS	CONDITIONS	Min.	Typ.	Max.	UNIT
Hysteresis Voltage	V_{HS}	Hysteresis Input		-	0.7	-	V
Input Current	I_{IN1}	Port K0, TEST, RESET, HOLD	$V_{DD} = 5.5V,$	-	-	± 2	μA
	I_{IN2}	Ports R4-R9 (open drain)	$V_{IN} = 5.5V / 0V$				
Input Low Current	I_{IL}	Ports R4-R6 (push-pull)	$V_{DD} = 5.5V, V_{IN} = 0.4V$	-	-	-2	mA
Input Resistance	R_{IN1}	Port K0 with pull-up/ pull-down		30	70	150	K Ω
	R_{IN2}	RESET		100	220	450	
Output Leakage Current	I_{LO}	Ports R4-R9 (open drain)	$V_{DD} = 5.5V, V_{OUT} = 5.5V$	-	-	2	μA
Output High Voltage	V_{OH}	Ports R4-R6 (push-pull)	$V_{DD} = 4.5V, I_{OH} = -200\mu A$	2.4	-	-	V
Output Low Voltage	V_{OL}	Except XOUT pin	$V_{DD} = 4.5V, I_{OL} = 1.6mA$	-	-	0.4	V
Segment Output Resistance	R_{OS}	SEG pin	$V_{DD} = 5V, V_{DD} - V_{LC} = 3V$	-	20	-	K Ω
Common Output Resistance	R_{OC}	COM pin					
Segment/Common Output Voltage	$V_{O2/3}$	SEG / COM pin					
	$V_{O1/2}$		3.8	3.5	3.7		
	$V_{O1/3}$		2.8	3.0	3.2		
Supply Current (in the Normal operating mode)	I_{DD}		$V_{DD} = 5.5V, V_{LC} = V_{SS}$ $f_c = 4MHz$	-	3	6	mA
Supply Current (in the HOLD operating mode)	I_{DDH}		$V_{DD} = 5.5V$	-	0.5	10	μA

Note1. Typ. values show those at $T_{opr} = 25^{\circ}C, V_{DD} = 5V.$

Note2. Input Current I_{IN1} : The current through resistor is not included, when the input resistor (pull-up / pull-down) is contained.

Note3. Output resistance R_{OS}, R_{OC} : indicates the on resistance during level switching.

Note4. $V_{O2/3}$: indicates 2/3 level output voltage when driving at 1/4 or 1/3 duty.

Note5. $V_{O1/2}$: indicates 1/2 level output voltage for 1/2 duty or static drive.

Note6. $V_{O1/3}$: indicates 1/3 level output voltage when driving at 1/4 or 1/3 duty.

Note7. Supply Current: $V_{IN} = 5.3V/0.2V.$

The voltage applied to the port R is within the valid range V_{IL} or $V_{IH}.$

TOSHIBA

TMP47C221A/421A/921A

A.C. CHARACTERISTICS

 $(V_{SS} = 0V, V_{DD} = 4.5 \text{ to } 6.0V, T_{opr} = -30 \text{ to } 70^\circ\text{C})$

PARAMETER	SYMBOL	CONDITIONS	Min.	Typ.	Max.	UNIT
Instruction Cycle Time	t_{cy}		1.9	—	20	μs
High level Clock pulse Width	t_{WCH}	External clock mode	80	—	—	ns
Low level Clock pulse Width	t_{WCL}					
Shift data Hold Time	t_{SDH}		$0.5t_{cy} - 300$	—	—	ns

Note. Shift data Hold Time:

External circuit for \overline{SCK} pin and SO pin

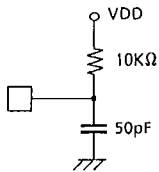

Serial port (completion of transmission)

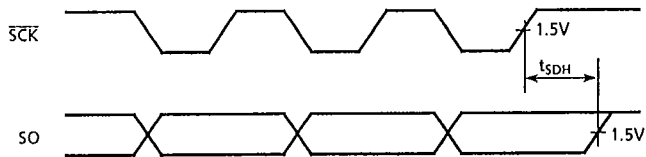

RECOMMENDED OSCILLATING CONDITIONS

 $(V_{SS} = 0V, V_{DD} = 4.5 \text{ to } 6.0V, T_{opr} = -30 \text{ to } 70^\circ\text{C})$

(1) 4MHz

Ceramic Resonator

CSA4.00MG (MURATA)

 $C_{XIN} = C_{XOUT} = 30\text{pF}$

KBR-4.00MS (KYOCERA)

 $C_{XIN} = C_{XOUT} = 30\text{pF}$

Crystal Oscillator

204B-6F 4.0000 (TOYOCOM)

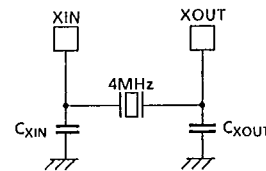
 $C_{XIN} = C_{XOUT} = 20\text{pF}$ 

(2) 400KHz

Ceramic Resonator

CSB400B (MURATA)

 $C_{XIN} = C_{XOUT} = 220\text{pF}, R_{XOUT} = 6.8\text{K}\Omega$

KBR-400B (KYOCERA)

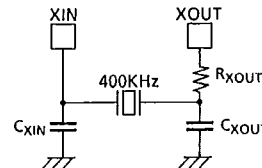
 $C_{XIN} = C_{XOUT} = 100\text{pF}, R_{XOUT} = 10\text{K}\Omega$ 

TOSHIBA

TMP47C221A/421A/921A

TYPICAL CHARACTERISTICS

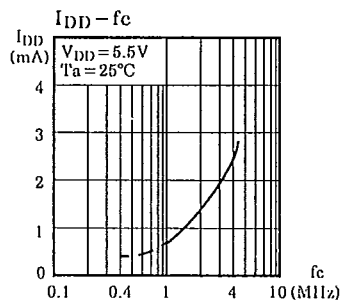
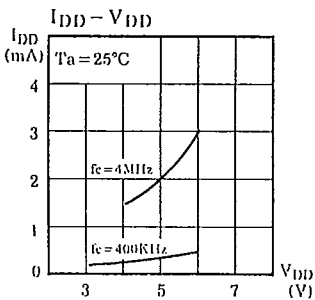
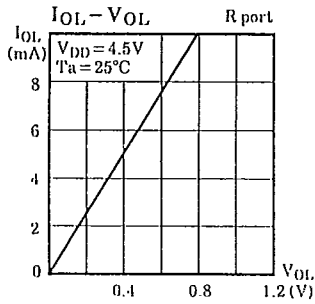
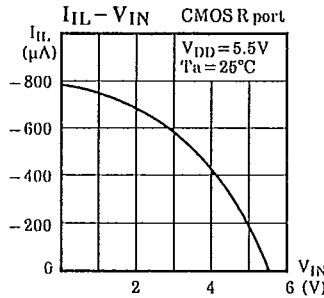
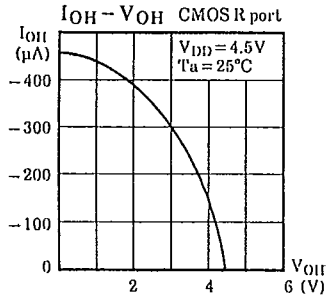
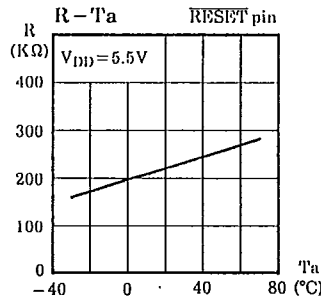
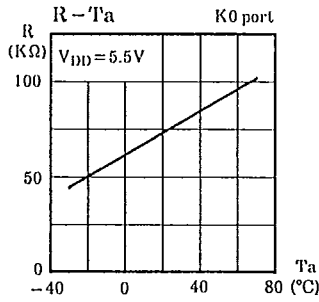

TOSHIBA

TMP47C221A/421A/921A

INPUT/OUTPUT CIRCUITRY

(1) Control pins

Input/Output circuitries of the 47C221A/421A control pins are similar to that of the 47C200A/400A.

(2) I/O Ports

The input/output circuitries of the 47C221A/421A I/O ports are shown below, any one of the circuitries can be chosen by a code (GA-GF) as a mask option.

PORT	I/O	INPUT/OUTPUT CIRCUITRY and CODE			REMARKS
		GA, GD	GB, GE	GC, GF	
K0	Input				pull-up/pull-down resistor $R_{IN} = 70K\Omega$ (typ.) $R = 1K\Omega$ (typ.)
R4 R5 R6	I/O	GA, GB, GC Initial "Hi-Z" 		GD, GE, GF Initial "High" 	Sink open drain or push-pull output $R = 1K\Omega$ (typ.)
R7	I/O				Sink open drain output Initial "Hi-Z" $R = 1K\Omega$ (typ.)
R8 R9	I/O				Sink open drain output Initial "Hi-Z" Hysteresis input $R = 1K\Omega$ (typ.)

TOSHIBA

TMP47C221A/421A/921A

CMOS 4-BIT MICROCONTROLLER

TMP47C921AG

The 47C921A, which is equipped with an EPROM as program memory, is a piggyback type evaluator chip used for development and operational confirmation of the 47C221A/421A application systems (programs). The 47C921A is pin compatible with the 47C221A/421A which are mask-programmed ROM devices.

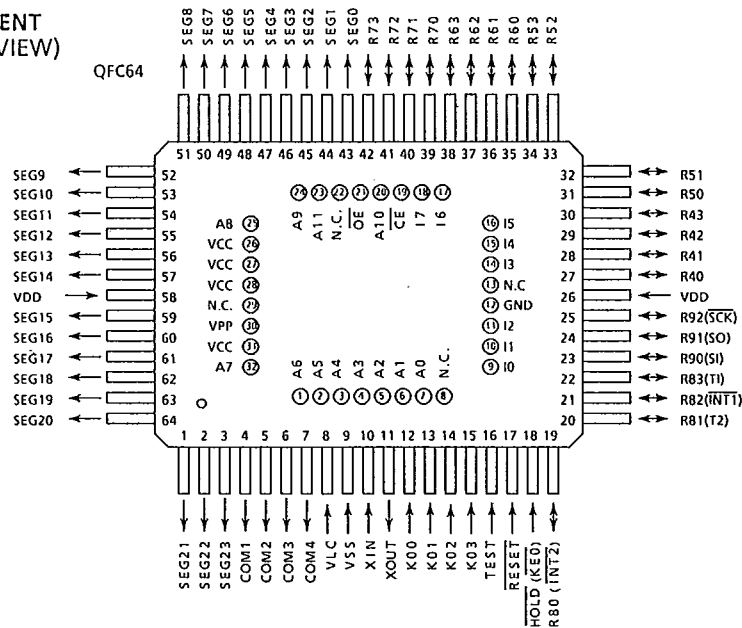
PIN ASSIGNMENT
(TOP VIEW)

PIN FUNCTION (Top of the package)

PIN NAME	Input / Output	FUNCTIONS
A11 ~ A0	Output	Program memory address output
I7 ~ I0	Input	Program memory data input
\overline{CE}	Output	Chip enable signal output
\overline{OE}		Output enable signal output
VCC	Power supply	+ 5V (connected with VDD)
GND		0V (connected with VSS)

A.C. CHARACTERISTICS

PARAMETER	SYMBOL	CONDITIONS	Min.	Typ.	Max.	UNIT
Address Delay Time	t_{AD}	$V_{SS} = 0V, V_{DD} = 4.5 \text{ to } 6.0V$	—	—	150	ns
Data Setup Time	t_{IS}	$C_L = 100pF$	150	—	—	ns
Data Hold Time	t_{IH}	$T_{opr} = -30 \text{ to } 70^\circ C$	50	—	—	ns

TOSHIBA

TMP47C221A/421A/921A

NOTES FOR USE

(1) Program memory

The program area are as shown in Figure 1.

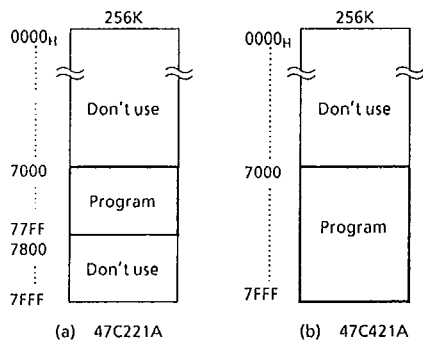

Figure 1. Program area

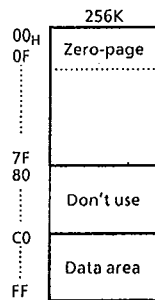

Figure 2. RAM addressing

(2) Data memory

The 47C921A contains 256 × 4-bit data memory. When the 47C921A is used as the 47C221A evaluator, programming should be performed assuming that the RAM is assigned to addresses 00H - 7FH and C0H - FFH as shown in Figure 2.

(3) I/O ports

Input/Output circuitries of I/O ports in the 47C921A are similar to the code GA of the 47C221A/421A. When this chip is used as evaluator with other I/O code, it is necessary to provide the external resistors.

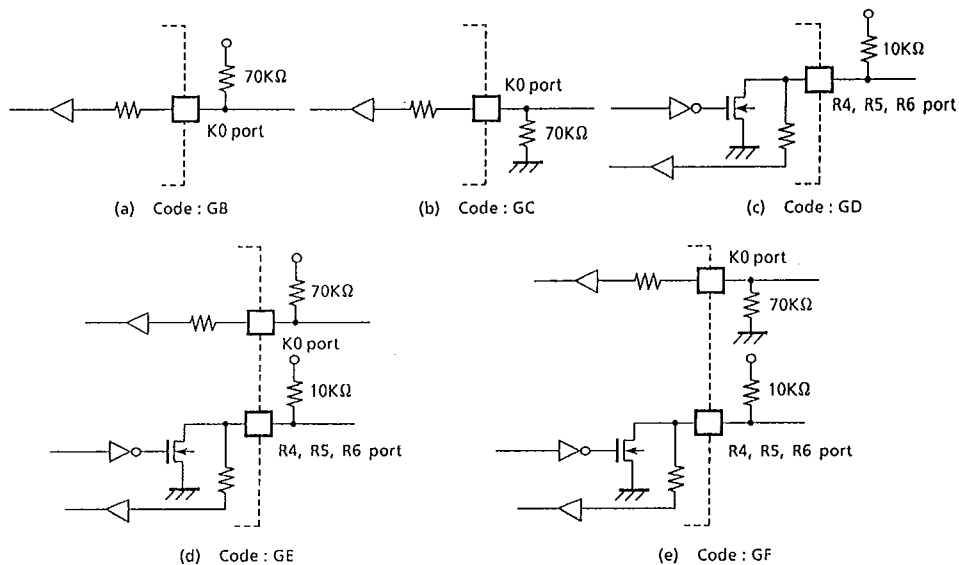

Figure 3. I/O code and external circuitry