

- ◆ N-Channel/P-Channel Power MOS FET
- ◆ DMOS Structure
- ◆ Low On-State Resistance : 0.045Ω max (Nch)
0.110Ω max (Pch)
- ◆ Ultra High-Speed Switching
- ◆ SOP - 8 Package
- ◆ Two FET Devices Built-in

- Applications
- Notebook PCs
- Cellular and portable phones
- On - board power supplies

■ General Description

The XP135A1145SR is a N-Channel/P-Channel Power MOS FET with low on-state resistance and ultra high-speed switching characteristics.

Two FET devices are built-into the one package.

Because high-speed switching is possible, the IC can be efficiently set thereby saving energy.

The small SOP-8 package makes high density mounting possible.

■ Features

Low on-state resistance (Nch) :

$R_{ds(on)} = 0.033\Omega$ ($V_{gs} = 10V$)

$R_{ds(on)} = 0.045\Omega$ ($V_{gs} = 4.5V$)

Low on-state resistance (Pch) :

$R_{ds(on)} = 0.065\Omega$ ($V_{gs} = -10V$)

$R_{ds(on)} = 0.110\Omega$ ($V_{gs} = -4.5V$)

Ultra high-speed switching

Operational Voltage : 4.5V (Nch) : -4.5V (Pch)

High density mounting : SOP - 8

■ Pin Configuration

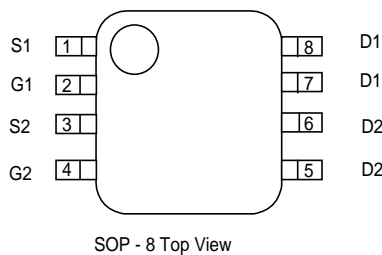

■ Pin Assignment

PIN NUMBER	PIN NAME	FUNCTION
1	S1	Source (Nch)
2	G1	Gate (Nch)
3	S2	Source (Pch)
4	G2	Gate (Pch)
5 - 6	D2	Drain (Pch)
7 - 8	D1	Drain (Nch)

■ Equivalent Circuit

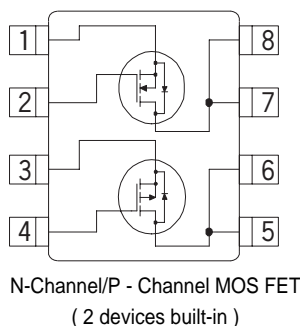

■ Absolute Maximum Ratings

PARAMETER	SYMBOL	RATINGS		UNITS
		Nch	Pch	
Drain - Source Voltage	V_{dss}	30	- 30	V
Gate - Source Voltage	V_{gss}	± 20	± 20	V
Drain Current (DC)	I_d	6	- 4	A
Drain Current (Pulse)	I_{dp}	20	- 16	A
Reverse Drain Current	I_{dr}	6	- 4	A
Continuous Channel Power Dissipation (note)	P_d	2		W
Channel Temperature	T_{ch}	150		$^{\circ}C$
Storage Temperature	T_{stg}	- 55 to 150		$^{\circ}C$

(note) : When implemented on a glass epoxy PCB

Electrical Characteristics

DC characteristics (P-Channel Power MOS FET)

Ta=25°C

PARAMETER	SYMBOL	CONDITIONS	MIN	TYP	MAX	UNITS
Drain Cut-off Current	Idss	Vds = - 30 , Vgs = 0V			- 10	μA
Gate-Source Leakage Current	Igss	Vgs = ± 20 , Vds = 0V			± 1	μA
Gate-Source Cut-off Voltage	Vgs (off)	Id = -1mA , Vds = -10V	- 1		- 2.5	V
Drain-Source On-state Resistance (note)	Rds (on)	Id = - 2A , Vgs = -10V		0.055	0.065	Ω
		Id = - 2A , Vgs = - 4.5V		0.09	0.11	Ω
Forward Transfer Admittance (note)	Yfs	Id = - 2A , Vds = - 10V		5		S
Body Drain Diode Forward Voltage	Vf	If = - 4A , Vgs = 0V		- 0.85	- 1.1	V

(note) : Effective during pulse test.

Dynamic characteristics

Ta=25°C

PARAMETER	SYMBOL	CONDITIONS	MIN	TYP	MAX	UNITS
Input Capacitance	Ciss	Vds = - 10V , Vgs = 0V f = 1 MHz		680		pF
Output Capacitance	Coss			450		pF
Feedback Capacitance	Crss			170		pF

Switching characteristics

Ta=25°C

PARAMETER	SYMBOL	CONDITIONS	MIN	TYP	MAX	UNITS
Turn-on Delay Time	td (on)	Vgs = - 5V , Id = - 2A Vdd = - 10V		15		ns
Rise Time	tr			20		ns
Turn-off Delay Time	td (off)			30		ns
Fall Time	tf			20		ns

Thermal characteristics

PARAMETER	SYMBOL	CONDITIONS	MIN	TYP	MAX	UNITS
Thermal Resistance (channel - surroundings)	Rth (ch - a)	Implement on a glass epoxy resin PCB		62.5		°C / W

■ Electrical Characteristics

DC characteristics (N-Channel Power MOS FET)

Ta=25°C

PARAMETER	SYMBOL	CONDITIONS	MIN	TYP	MAX	UNITS
Drain Cut-off Current	Idss	Vds = 30 , Vgs = 0V			10	μA
Gate-Source Leakage Current	Igss	Vgs = ± 20 , Vds = 0V			± 1	μA
Gate-Source Cut-off Voltage	Vgs (off)	Id = 1mA , Vds = 10V	1.0		2.5	V
Drain-Source On-state Resistance (note)	Rds (on)	Id = 3A , Vgs = 10V		0.026	0.033	Ω
		Id = 3A , Vgs = 4.5V		0.035	0.045	Ω
Forward Transfer Admittance (note)	Yfs	Id = 3A , Vds = 10V		12		S
Body Drain Diode Forward Voltage	Vf	If = 6A , Vgs = 0V		0.85	1.1	V

(note) : Effective during pulse test.

Dynamic characteristics

Ta=25°C

PARAMETER	SYMBOL	CONDITIONS	MIN	TYP	MAX	UNITS
Input Capacitance	Ciss	Vds = 10V , Vgs = 0V f = 1 MHz		620		pF
Output Capacitance	Coss			350		pF
Feedback Capacitance	Crss			120		pF

Switching characteristics

Ta=25°C

PARAMETER	SYMBOL	CONDITIONS	MIN	TYP	MAX	UNITS
Turn-on Delay Time	td (on)	Vgs = 5V , Id = 3A Vdd = 10V		15		ns
Rise Time	tr			20		ns
Turn-off Delay Time	td (off)			30		ns
Fall Time	tf			10		ns

Thermal characteristics

PARAMETER	SYMBOL	CONDITIONS	MIN	TYP	MAX	UNITS
Thermal Resistance (channel - surroundings)	Rth (ch - a)	Implement on a glass epoxy resin PCB		62.5		°C / W

Electrical Characteristics (N-channel Power MOS FET)

Drain Current vs. Drain/Source Voltage

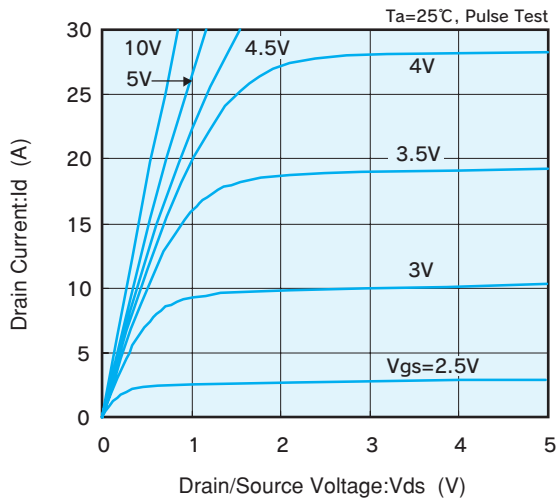

Drain Current vs. Gate/Source Voltage

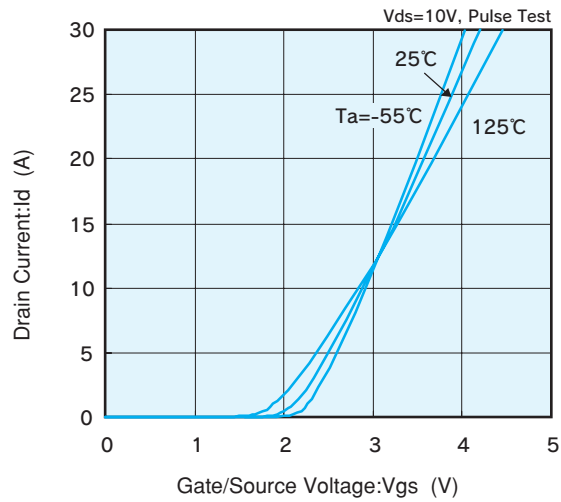

Drain/Source On-State Resistance vs. Gate/Source Voltage

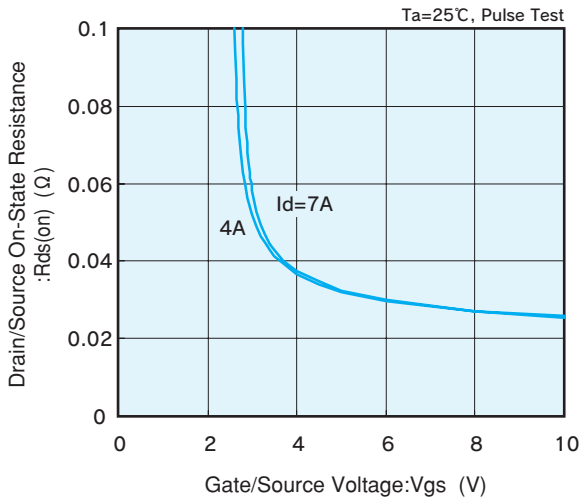

Drain/Source On-State Resistance vs. Drain Current

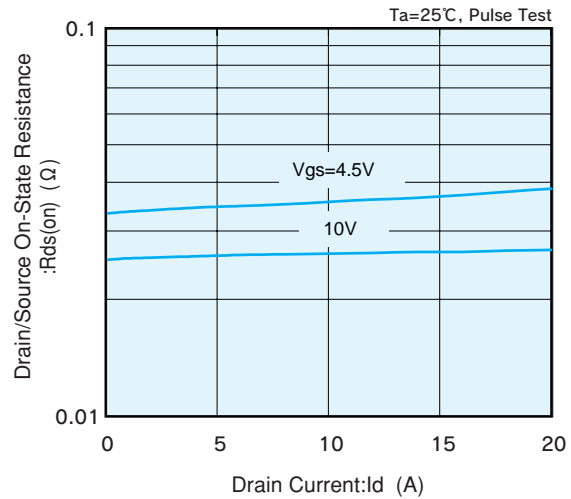

Drain/Source On-State Resistance vs. Ambient Temp

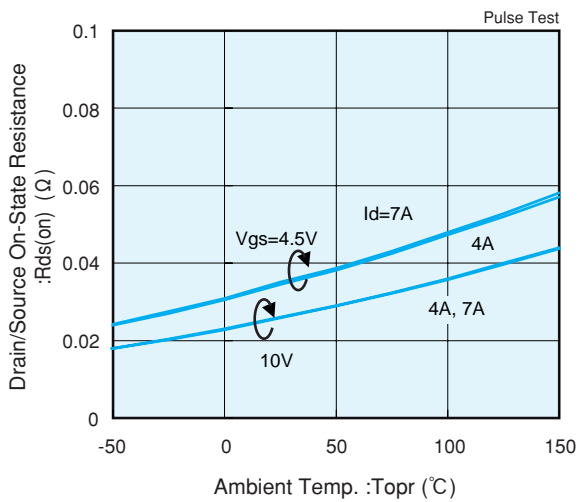

Gate/Source Cut Off Voltage Variance vs. Ambient Temp.

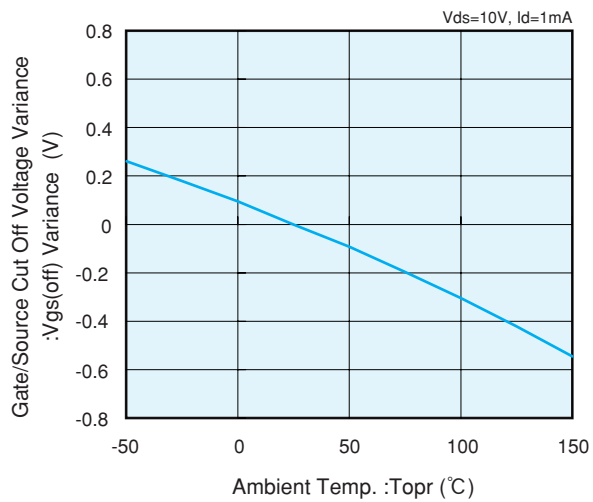

7

Electrical Characteristics (N-channel Power MOS FET)

Capacitance vs. Drain/Source Voltage

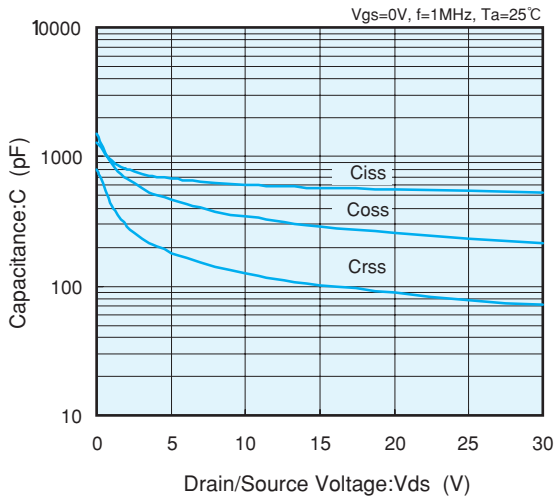

Switching Time vs. Drain Current

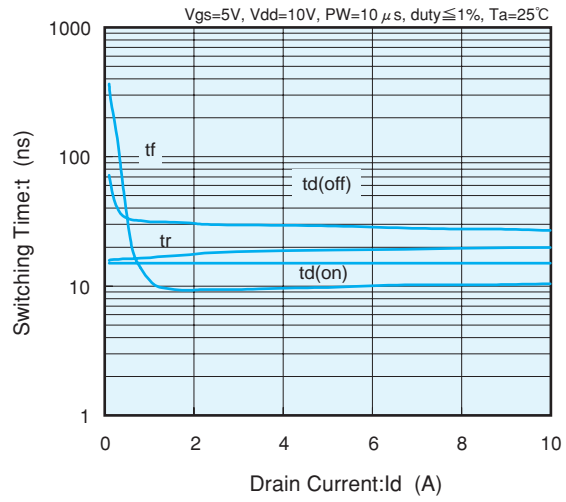

Gate/Source Voltage vs. Gate Charge

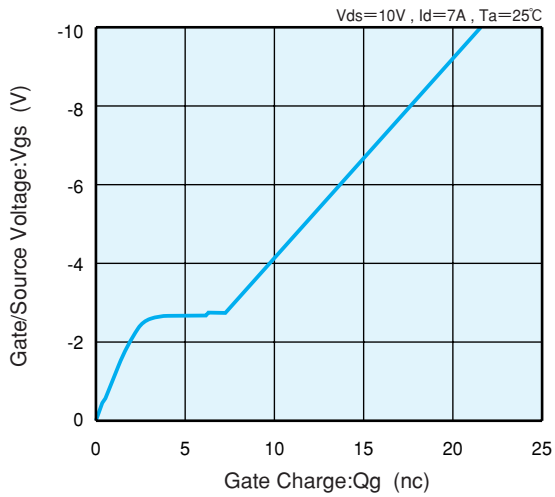

Reverse Drain Current vs. Source/Drain Voltage

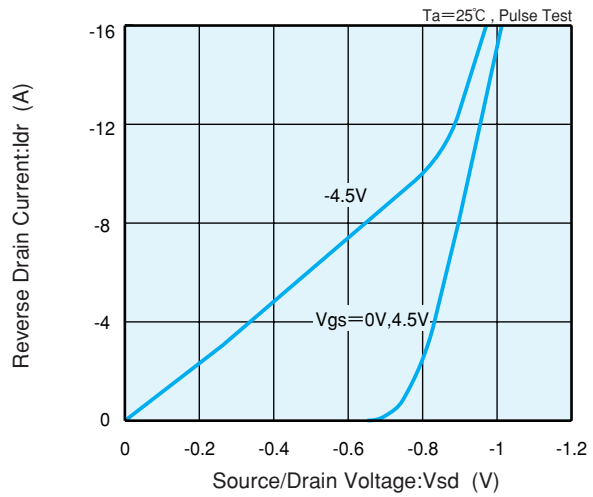

Standardized Transition Thermal Resistance vs. Pulse Width

