

MegaMOS™ FET

IXTH 35N30
IXTH 40N30
IXTM 40N30

V_{DSS}	I_{D25}	$R_{DS(on)}$
300 V	35 A	0.10 Ω
300 V	40 A	0.085 Ω
300 V	40 A	0.088 Ω

N-Channel Enhancement Mode



Symbol	Test Conditions	Maximum Ratings	
V_{DSS}	$T_J = 25^\circ\text{C}$ to 150°C	300	V
V_{DGR}	$T_J = 25^\circ\text{C}$ to 150°C ; $R_{GS} = 1\text{ M}\Omega$	300	V
V_{GS}	Continuous	± 20	V
V_{GSM}	Transient	± 30	V
I_{D25}	$T_C = 25^\circ\text{C}$	35N30	35 A
		40N30	40 A
I_{DM}	$T_C = 25^\circ\text{C}$, pulse width limited by T_{JM}	35N30	140 A
		40N30	160 A
P_D	$T_C = 25^\circ\text{C}$	300	W
T_J		-55 ... +150	$^\circ\text{C}$
T_{JM}		150	$^\circ\text{C}$
T_{stg}		-55 ... +150	$^\circ\text{C}$
M_d	Mounting torque	1.13/10	Nm/lb.in.
Weight		TO-204 = 18 g, TO-247 = 6 g	
Maximum lead temperature for soldering 1.6 mm (0.062 in.) from case for 10 s		300	$^\circ\text{C}$

TO-247 AD (IXTH)

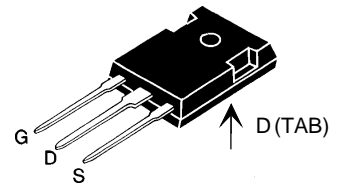

TO-204 AE (IXTM)

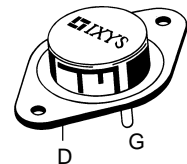

G = Gate, D = Drain,
S = Source, TAB = Drain

Features

- International standard packages
- Low $R_{DS(on)}$ HDMOS™ process
- Rugged polysilicon gate cell structure
- Low package inductance (< 5 nH)
 - easy to drive and to protect
- Fast switching times

Applications

- Switch-mode and resonant-mode power supplies
- Motor controls
- Uninterruptible Power Supplies (UPS)
- DC choppers

Advantages

- Easy to mount with 1 screw (TO-247) (isolated mounting screw hole)
- Space savings
- High power density

Symbol	Test Conditions	Characteristic Values ($T_J = 25^\circ\text{C}$, unless otherwise specified)		
		min.	typ.	max.
V_{DSS}	$V_{GS} = 0\text{ V}$, $I_D = 250\ \mu\text{A}$	300		V
$V_{GS(th)}$	$V_{DS} = V_{GS}$, $I_D = 250\ \mu\text{A}$	2		V
I_{GSS}	$V_{GS} = \pm 20\text{ V}_{DC}$, $V_{DS} = 0$			$\pm 100\text{ nA}$
I_{DSS}	$V_{DS} = 0.8 \cdot V_{DSS}$ $V_{GS} = 0\text{ V}$	$T_J = 25^\circ\text{C}$		200 μA
		$T_J = 125^\circ\text{C}$		1 mA
$R_{DS(on)}$	$V_{GS} = 10\text{ V}$, $I_D = 0.5 I_{D25}$ Pulse test, $t \leq 300\ \mu\text{s}$, duty cycle $d \leq 2\%$	IXTH35N30		0.10 Ω
		IXTH40N30 IXTM40N30		0.085 Ω 0.088 Ω

Symbol	Test Conditions	Characteristic Values ($T_J = 25^\circ\text{C}$, unless otherwise specified)			
		min.	typ.	max.	
g_{fs}	$V_{DS} = 10\text{ V}; I_D = 0.5 \cdot I_{D25}$, pulse test	22	25	S	
C_{iss}	$V_{GS} = 0\text{ V}, V_{DS} = 25\text{ V}, f = 1\text{ MHz}$		4600	pF	
C_{oss}			650	pF	
C_{rss}			240	pF	
$t_{d(on)}$	$V_{GS} = 10\text{ V}, V_{DS} = 0.5 \cdot V_{DSS}, I_D = 0.5 I_{D25}$ $R_G = 2\ \Omega$, (External)		24	30	ns
t_r			40	90	ns
$t_{d(off)}$			75	100	ns
t_f			40	90	ns
$Q_{g(on)}$	$V_{GS} = 10\text{ V}, V_{DS} = 0.5 \cdot V_{DSS}, I_D = 0.5 I_{D25}$		190	220	nC
Q_{gs}			28	50	nC
Q_{gd}			85	105	nC
R_{thJC}			0.42	K/W	
R_{thCK}		0.25		K/W	

Source-Drain Diode

Symbol	Test Conditions	Characteristic Values ($T_J = 25^\circ\text{C}$, unless otherwise specified)		
		min.	typ.	max.
I_S	$V_{GS} = 0\text{ V}$	35N30 40N30		35 A 40 A
I_{SM}	Repetitive; pulse width limited by T_{JM}	35N30 40N30		140 A 160 A
V_{SD}	$I_F = I_S, V_{GS} = 0\text{ V}$, Pulse test, $t \leq 300\ \mu\text{s}$, duty cycle $d \leq 2\%$			1.5 V
t_{rr}	$I_F = I_S, -di/dt = 100\text{ A}/\mu\text{s}, V_R = 100\text{ V}$		400	ns

TO-247 AD (IXTH) Outline

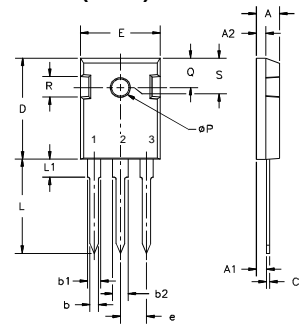

Terminals: 1 - Gate 2 - Drain
3 - Source Tab - Drain

Dim.	Millimeter		Inches	
	Min.	Max.	Min.	Max.
A	4.7	5.3	.185	.209
A ₁	2.2	2.54	.087	.102
A ₂	2.2	2.6	.059	.098
b	1.0	1.4	.040	.055
b ₁	1.65	2.13	.065	.084
b ₂	2.87	3.12	.113	.123
C	.4	.8	.016	.031
D	20.80	21.46	.819	.845
E	15.75	16.26	.610	.640
e	5.20	5.72	0.205	0.225
L	19.81	20.32	.780	.800
L1		4.50		.177
ØP	3.55	3.65	.140	.144
Q	5.89	6.40	0.232	0.252
R	4.32	5.49	.170	.216
S	6.15	BSC	242	BSC

TO-204AE (IXTM) Outline

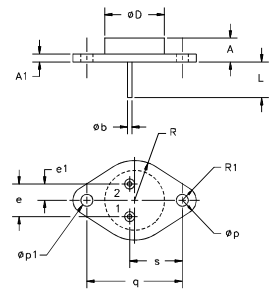

Pins 1 - Gate 2 - Source
Case - Drain

Dim.	Millimeter		Inches	
	Min.	Max.	Min.	Max.
A	6.4	11.4	.250	.450
A ₁	1.53	3.42	.060	.135
Øb	1.45	1.60	.057	.063
ØD		22.22		.875
e	10.67	11.17	.420	.440
e ₁	5.21	5.71	.205	.225
L	11.18	12.19	.440	.480
Øp	3.84	4.19	.151	.165
Øp ₁	3.84	4.19	.151	.165
q	30.15	BSC	1.187	BSC
R	12.58	13.33	.495	.525
R ₁	3.33	4.77	.131	.188
s	16.64	17.14	.655	.675

Fig. 1 Output Characteristics

Fig. 2 Input Admittance

Fig. 3 $R_{DS(on)}$ vs. Drain Current

Fig. 4 Temperature Dependence of Drain to Source Resistance

Fig. 5 Drain Current vs. Case Temperature

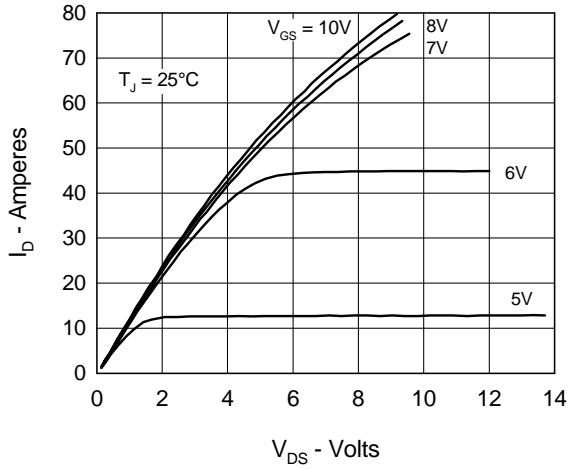
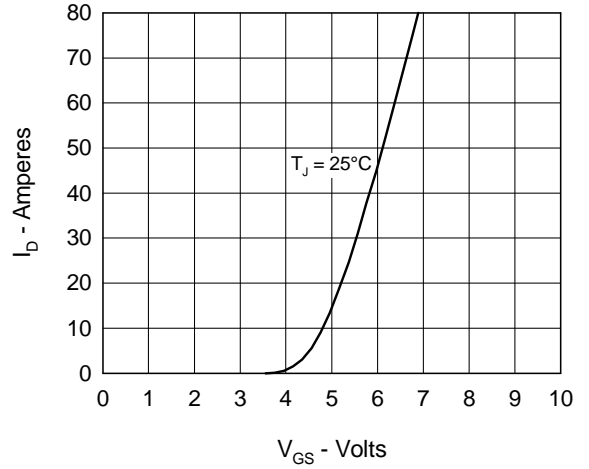
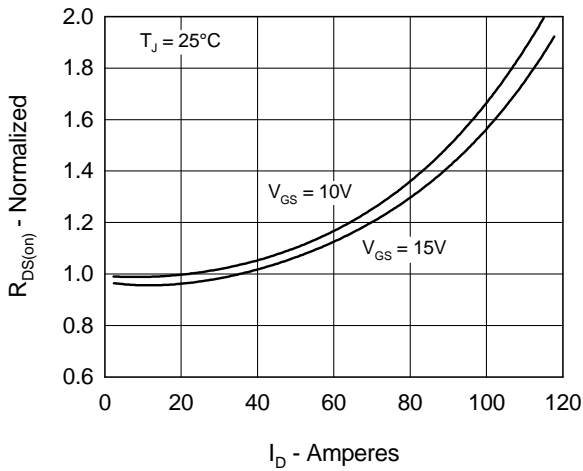
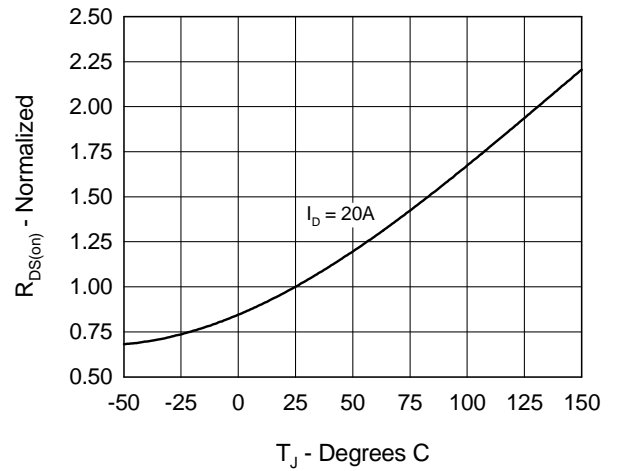
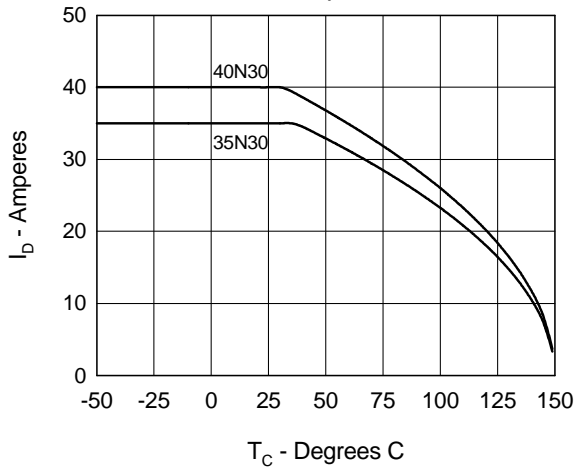
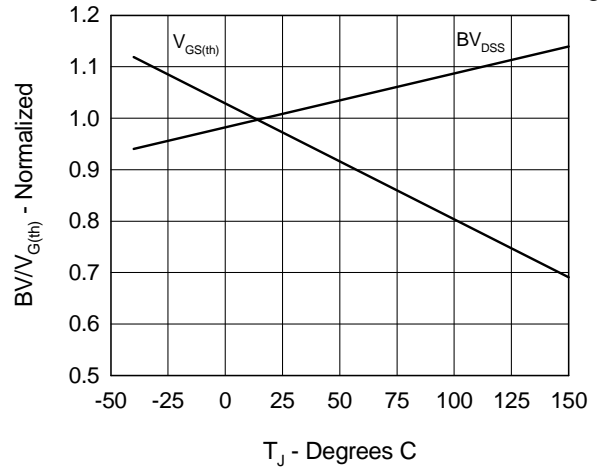
Fig. 6 Temperature Dependence of Breakdown and Threshold Voltage

Fig.7 Gate Charge Characteristic Curve

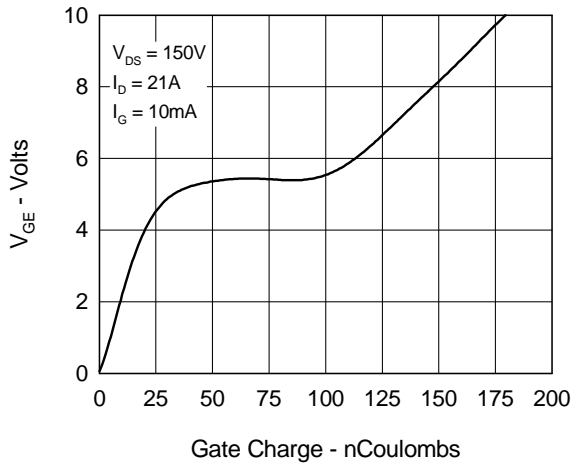

Fig.8 Forward Bias Safe Operating Area

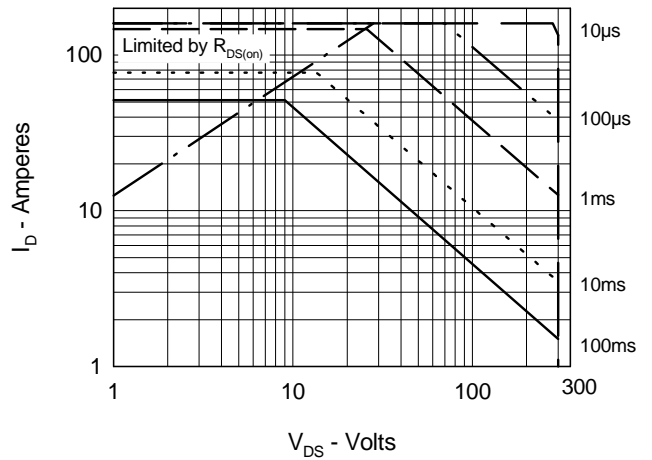

Fig.9 Capacitance Curves

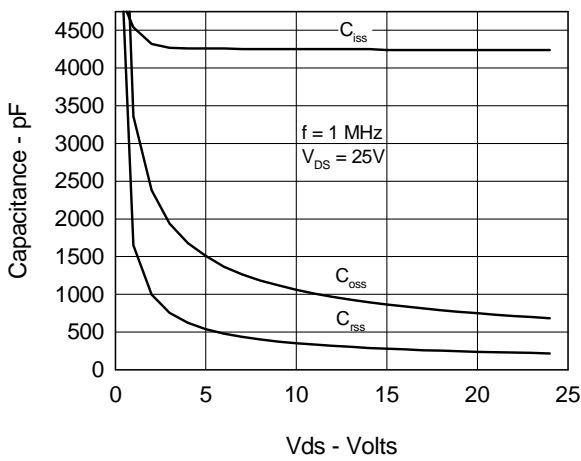

Fig.10 Source Current vs. Source to Drain Voltage

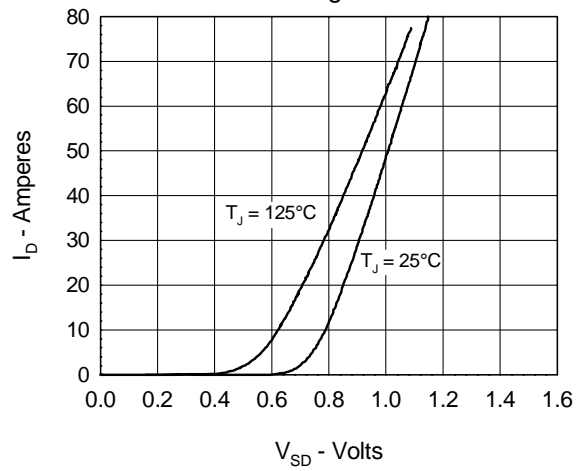

Fig.11 Transient Thermal Impedance

