

OKI Semiconductor

MSM64431

Built-in 8-Bit A/D Converter 4-Bit Microcontroller

GENERAL DESCRIPTION

The MSM64431 is a high-performance 4-bit microcontroller that incorporates OKI's nX-4/20 CPU core.

The MSM64431 has a minimum instruction execution time of 714 ns (@4.2 MHz) and contains a 1024-byte program memory, a 64-nibble data memory, four I/O ports (16 bits in total), an 8-bit 4-channel A/D converter, and a time base counter.

Applications include various types of controllers, remote-controllers, home appliances such as fans, and toys.

FEATURES

- Operating range
 - Operating frequency : 500 kHz to 4.2 MHz
 - Operating voltage : 4.5 to 5.5 V
 - Operating temperature : -40 to +85°C
- Internal program memory : 1024 bytes
- Internal data memory : 64 nibbles
- Minimum instruction execution time : 714 ns @ 4.2 MHz
- A/D converter : 8-bit; 4 channels
- I/O port
 - Input-output port : 1 port × 4 bits
 - Input port : 2 ports × 4 bits
 - Output port : 1 port × 4 bits
- External interrupt : 1
- Interrupt sources : 4
- Package options:
 - 24-pin plastic DIP (DIP24-P-600) : (Product name : MSM64431-xxxRS)
 - 24-pin plastic SOP (SOP24-P-430-K) : (Product name : MSM64431-xxxGS-K)xxx indicates the code number.

BLOCK DIAGRAM

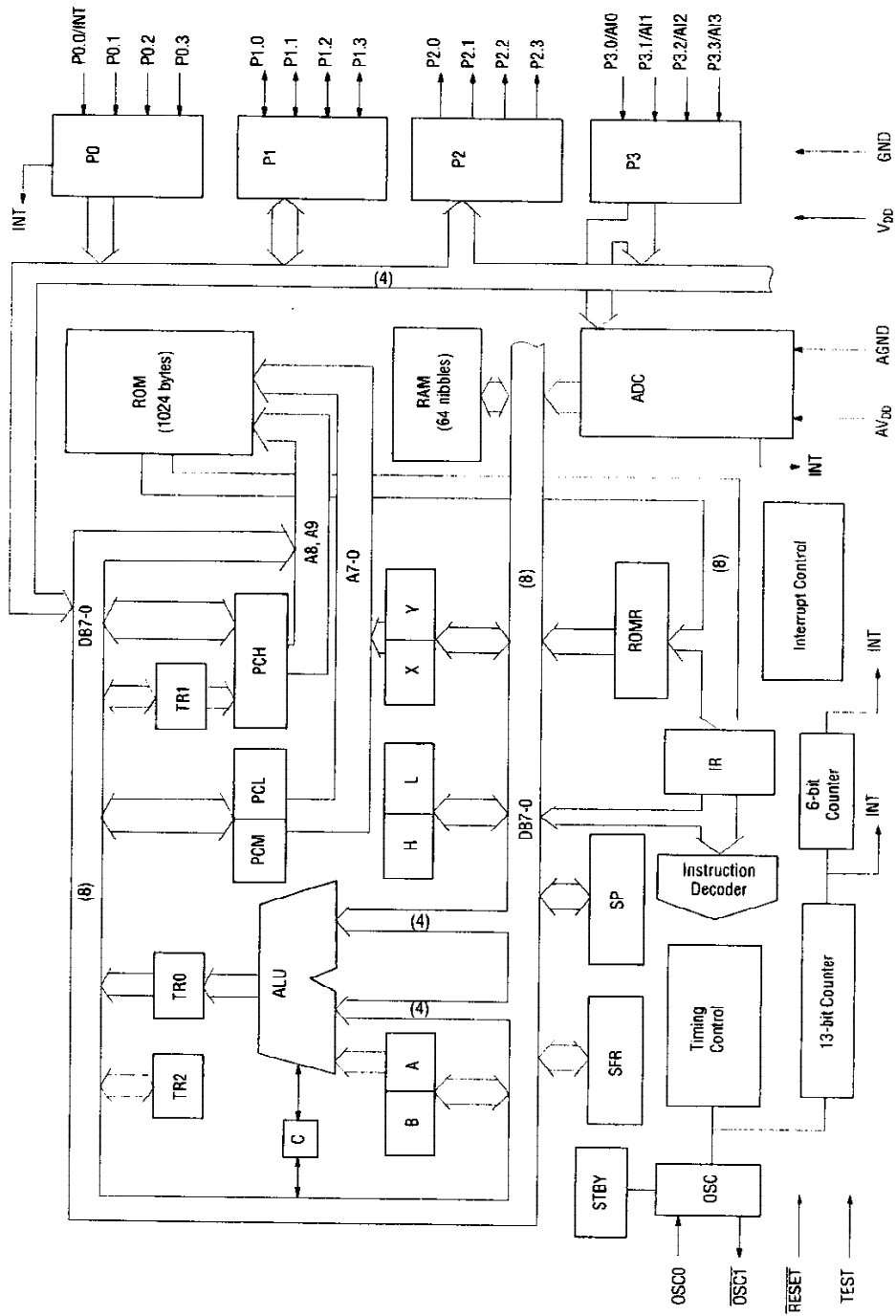

PIIN CONFIGURATION (TOP VIEW)

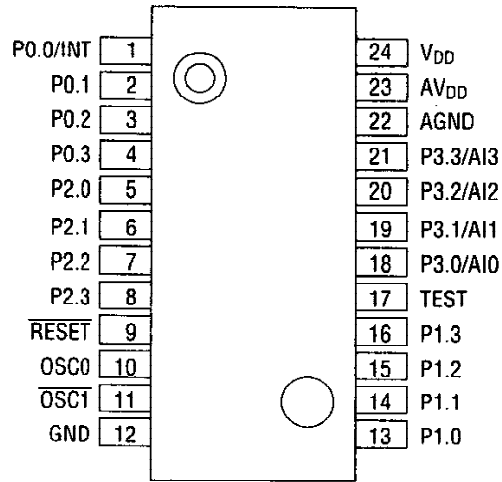

24-Pin Plastic SOP

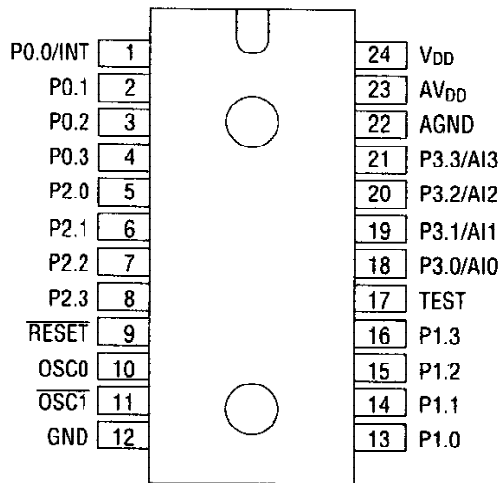

24-Pin Plastic DIP

PIN DESCRIPTIONS

Function	Symbol	Type	Description
Power supply	V _{DD}	—	+5 V digital power supply
	GND	—	0 V digital ground
	AV _{DD}	—	+5 V analog power supply
	AGND	—	0 V analog ground
Oscillation	OSC0	I	Oscillation input/external clock input
	OSC1	O	Oscillation output
Control	RESET	I	System reset (starts from address 0)
	TEST	I	Test only input
Ports	PORT 0	I	4-bit input port. P0.0's secondary function is an external interrupt input.
	PORT 1	I/O	4-bit input-output port
	PORT 2	O	4-bit output port
	PORT 3	I	4-bit input port. This port becomes an analog input channel at A/D conversion when set to perform its secondary function.

MEMORY MAPS

Program Memory

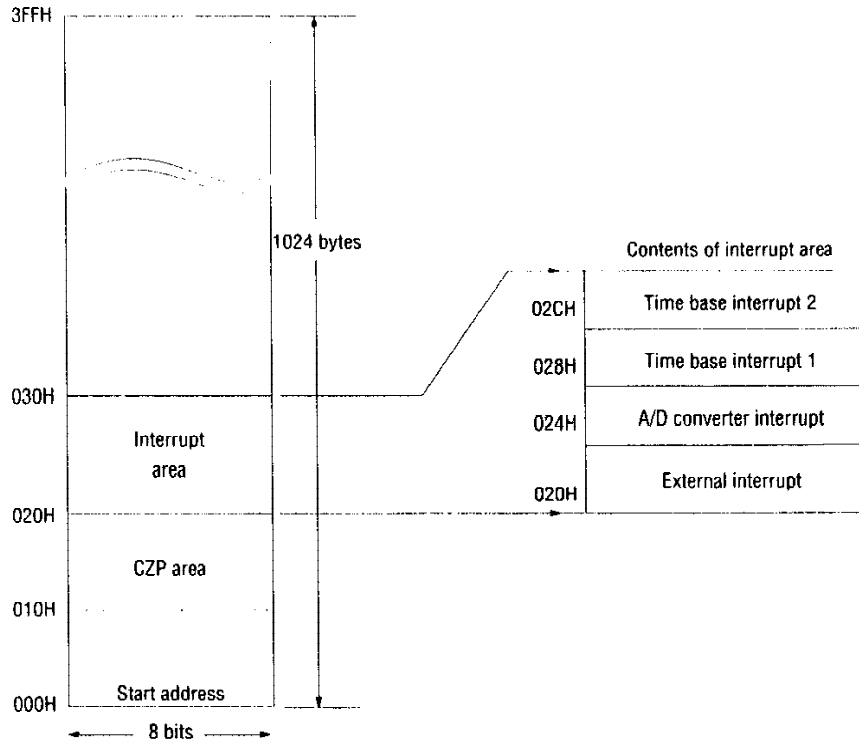

Program Memory Map

Address 000H is the instruction execution start address after system reset.
 The CZP area from address 010H to address 01FH is the start address area for the CZP subroutine of one-byte call instruction.
 The interrupt address from address 020H to 03DH is assigned the start address of interrupt subroutines.

Data Memory

Data memory is composed of eight banks with 256 nibbles (256 x 4 bits) in each bank. In data RAM, BANK 7 is assigned 64 nibbles and BANK 0 is assigned to Special Function Registers.

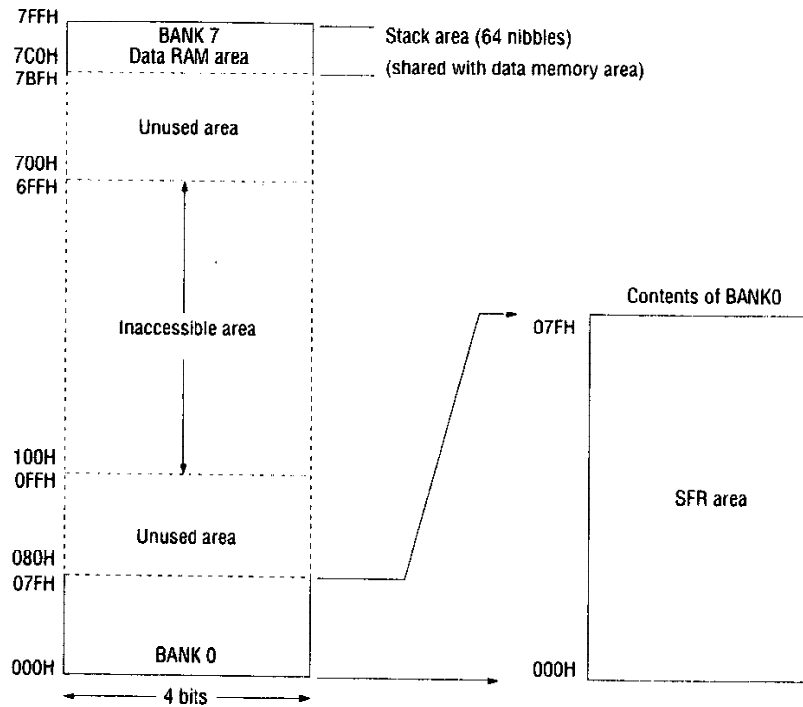

Data memory map

The stack area is memory that starts at address 7FFH and extends downwards. Four nibbles are used by subroutine call instructions and eight nibbles are used when interrupts are generated.

ABSOLUTE MAXIMUM RATINGS

Parameter	Symbol	Condition	Rating	Unit
Power supply voltage	$V_{DD} = AV_{DD}$	$T_a = 25^\circ\text{C}$ $GND = AGND = 0\text{ V}$	-0.3 to 7.0	V
Input voltage	V_I		-0.3 to $V_{DD}+0.3$	
Output voltage	V_O		-0.3 to $V_{DD}+0.3$	
Analog input voltage	V_{AI}		-0.3 to $V_{DD}+0.3$	
Storage temperature	T_{STG}	—	-55 to +150	$^\circ\text{C}$

RECOMMENDED OPERATING CONDITIONS

Parameter	Symbol	Condition	Range	Unit
Power supply voltage	$V_{DD} = AV_{DD}$	$f = 500\text{ kHz to }4.2\text{ MHz}$	4.5 to 5.5	V
Operating temperature	T_{op}	—	-40 to +85	$^\circ\text{C}$

ELECTRICAL CHARACTERISTICS

DC Characteristics

(V_{DD} = AV_{DD} = 5 V ± 10%, GND = AGND = 0 V, Ta = -40 to +85°C)

Parameter	Symbol	Condition	Min.	Typ.	Max.	Unit
"H" input voltage	*1 V _{IH1}	—	0.5 V _{DD}	—	V _{DD}	V
"H" input voltage	*2 V _{IH2}	—	0.7 V _{DD}	—	V _{DD}	V
"L" input voltage	*3 V _{IL}	—	0	—	0.2 V _{DD}	V
"H" output current	*4 I _{OH}	V _{OH} = V _{DD} - 1.0 V	1.0	—	—	mA
"L" output current	*4 I _{OL1}	V _{OL1} = 0.4 V	-1.6	—	—	mA
"L" output current	*5 I _{OL2}	V _{OL2} = 1.2 V	-10	—	—	mA
input leakage current	*6 I _{LI}	V _I = V _{DD} /0 V	—	—	±5	μA
Output leakage current	*5 I _{LO}	V _I = V _{DD} /0 V	—	—	±5	μA
Pull-up resistance	*7 R _{PU}	—	20	40	80	kΩ
Pull-down resistance	*8 R _{PD}	—	2	5	15	kΩ
Analog reference power supply current	*3 I _{REF}	V _{DD} = AV _{DD} = 5 V GND = AGND = 0 V	—	0.5	2.0	mA
Operating current consumption	I _{DD}	V _{DD} = AV _{DD} = 5 V f = 4.2 MHz (no load)	—	—	3	mA
Current consumption at HALT	*9 I _{DDH}	V _{DD} = AV _{DD} = 5 V f = 4.2 MHz (no load)	—	—	300	μA
Stand-by current	*9 I _{DDs}	V _{DD} = AV _{DD} = 2 V Ta = 25°C	—	—	2	μA

*1 Except OSC0, TEST and RESET

*2 OSC0, TEST and RESET

*3 All input pins

*4 P1, P2

*5 P2

*6 P0, P1, P3

*7 RESET, P0, P3

*8 TEST

*9 I_{REF} subtracted

A/D Converter Characteristics

(1) When $f = 1$ MHz $(V_{DD} = AV_{DD} = 5\text{ V} \pm 10\%, \text{GND} = \text{AGND} = 0\text{ V}, T_a = -40\text{ to }85^\circ\text{C})$

Parameter	Symbol	Condition	Min.	Typ.	Max.	Unit
Resolution	n	Refer to the recommended circuit (Figure 1) Analog input source impedance $R_I \leq 5\text{ k}\Omega$	—	—	8	bit
Linearity error	E_L		—	—	+1	LSB
Differential linearity error	E_D		—	—	± 0.5	LSB
Crosstalk	E_{CT}	Refer to the measuring circuit (Figure 2)	—	—	± 0.5	LSB
Conversion time	t_{CONV}	$f_{OSC} = 1\text{ MHz}$	—	60	—	$\mu\text{s}/\text{CH}$

(2) When $f = 4.2$ MHz $(V_{DD} = AV_{DD} = 5\text{ V} \pm 10\%, \text{GND} = \text{AGND} = 0\text{ V}, T_a = -40\text{ to }85^\circ\text{C})$

Parameter	Symbol	Condition	Min.	Typ.	Max.	Unit
Resolution	n	Refer to the recommended circuit (Figure 1) Analog input source impedance $R_I \leq 5\text{ k}\Omega$	—	—	8	bit
Linearity error	E_L		—	—	+1.5	LSB
Differential linearity error	E_D		—	—	± 0.5	LSB
Crosstalk	E_{CT}	Refer to the measuring circuit (Figure 2)	—	—	± 0.5	LSB
Conversion time	t_{CONV}	$f_{OSC} = 4.2\text{ MHz}$	—	14	—	$\mu\text{s}/\text{CH}$

Definition of Terms

- Resolution Capacity** This refers to the minimum input analog value that is distinguishable. For 8 bits, $2^8 = 256$ ($AV_{DD} \div 256$) can be resolved.
- Linearity Error** This refers to the variance between the ideal characteristics of an 8-bit A/D converter and the actual conversion characteristics when no quantized error is involved. Ideal conversion characteristics refer to steps that divide the voltage between AV_{DD} and AGND into 256.
- Differential Linearity Error** This refers to the smoothness of the conversion characteristics. The width of analog input voltage corresponding to the variation of digital output for 1 bit is ideally $1\text{LSB} = AV_{DD} \div 256$. The difference between this ideal bit size and a bit size at an arbitrary point in the conversion range is called differential linearity error.

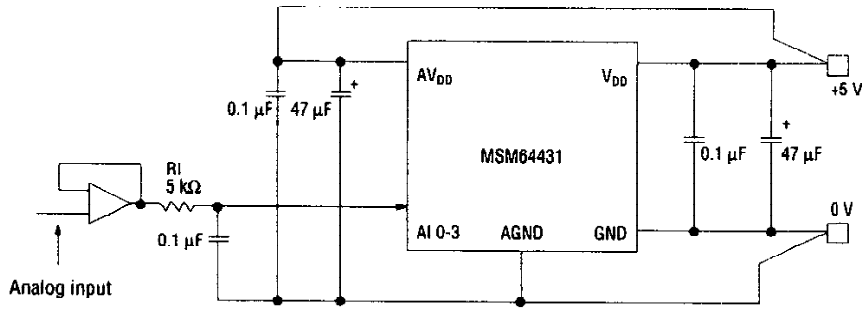

R_I (Analog input source impedance) $\leq 5 \text{ k}\Omega$

Figure 1. Recommended circuit

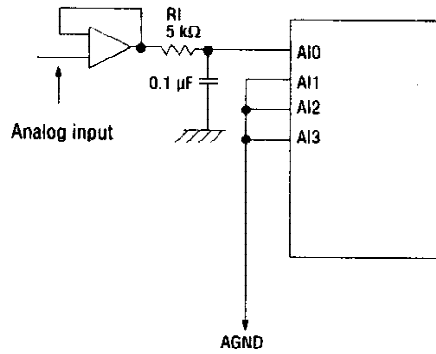

Analog input. The difference in the A/D conversion results between the identical analog input applied to AI 0-3 and the result by the left figure is taken to be caused by crosstalk.

Figure 2. Crosstalk measuring circuit