

GaAs PHEMT MMIC POWER AMPLIFIER, 2.0 - 20.0 GHz

Typical Applications

The HMC464 wideband driver is ideal for:

- Telecom Infrastructure
- Microwave Radio & VSAT
- Military & Space
- Test Instrumentation
- Fiber Optics

Functional Diagram

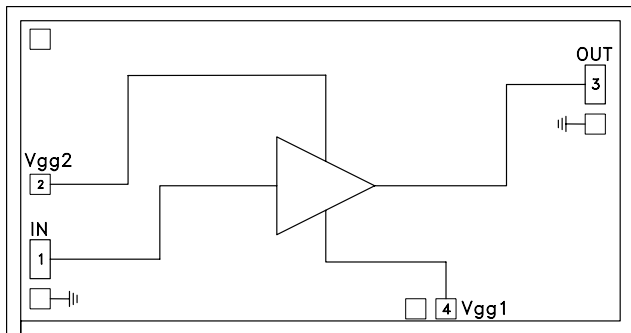

Features

- +26 dBm P1dB Output Power
- Gain: 16 dB
- +30 dBm Output IP3
- Supply Voltage: +8.0V @ 290 mA
- 50 Ohm Matched Input/Output
- 3.12 mm x 1.63 mm x 0.1 mm

General Description

The HMC464 is a GaAs MMIC PHEMT Distributed Power Amplifier die which operates between 2 and 20 GHz. The amplifier provides 16 dB of gain, +30 dBm Output IP3 and +26 dBm of output power at 1 dB gain compression while requiring 290 mA from a +8V supply. Gain flatness is excellent from 2 - 18 GHz making the HMC464 ideal for EW, ECM and radar driver amplifier applications. The HMC464 amplifier I/O's are internally matched to 50 Ohms facilitating easy integration into Multi-Chip-Modules (MCMs). All data is with the chip in a 50 Ohm test fixture connected via 0.025mm (1 mil) diameter wire bonds of minimal length 0.31mm (12 mils).

Electrical Specifications, $T_A = +25^\circ C$, $V_{dd} = 8V$, $V_{gg2} = 3V$, $I_{dd} = 290 mA^*$

Parameter	Min.	Typ.	Max.	Min.	Typ.	Max.	Min.	Typ.	Max.	Units
Frequency Range	2.0 - 6.0			6.0 - 18.0			18.0 - 20.0			GHz
Gain	14	16		13	16		11	14		dB
Gain Flatness		±0.25			±0.5			±0.75		dB
Gain Variation Over Temperature		0.02	0.03		0.02	0.03		0.03	0.04	dB/ °C
Input Return Loss		15			17			13		dB
Output Return Loss		14			12			11		dB
Output Power for 1 dB Compression (P1dB)	23.5	26.5		22	26		19	22		dBm
Saturated Output Power (Psat)		28			27.5			24.5		dBm
Output Third Order Intercept (IP3)		32			30			24		dBm
Noise Figure		4.0			4.0			6.0		dB
Supply Current (I _{dd}) (V _{dd} = 8V, V _{gg1} = -0.5V Typ.)		290			290			290		mA

* Adjust V_{gg1} between -2 to 0V to achieve I_{dd}= 290 mA typical.

GaAs PHEMT MMIC POWER AMPLIFIER, 2.0 - 20.0 GHz

Gain & Return Loss

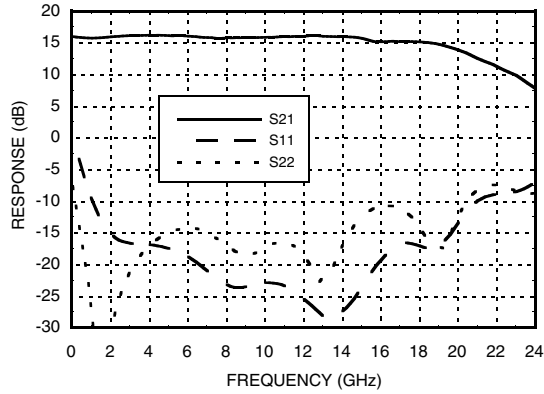

Gain vs. Temperature

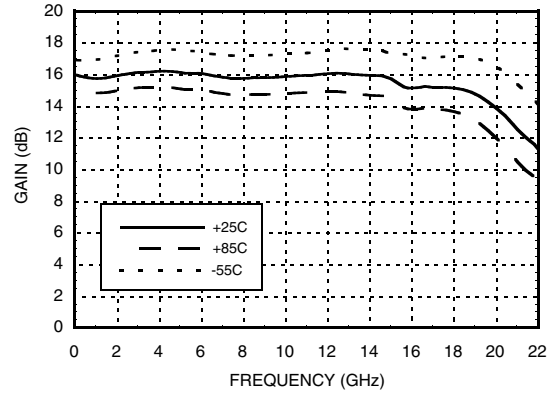

Input Return Loss vs. Temperature

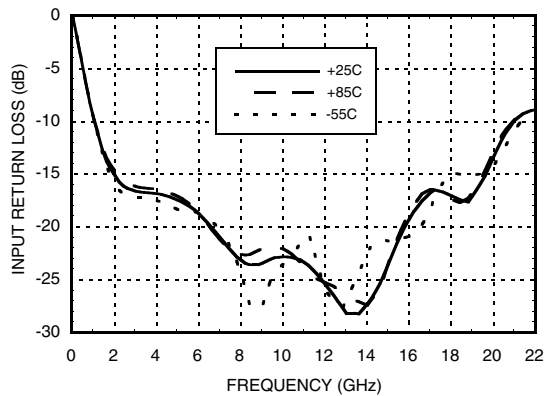

Output Return Loss vs. Temperature

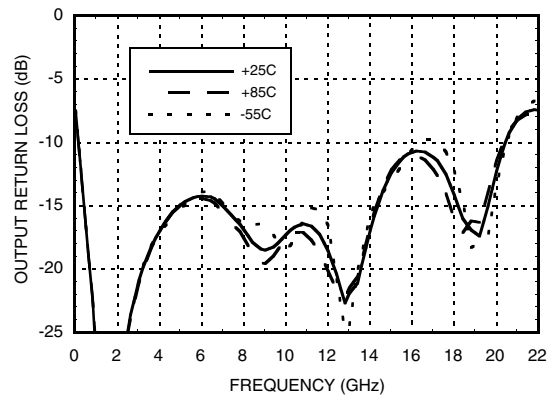

Reverse Isolation vs. Temperature

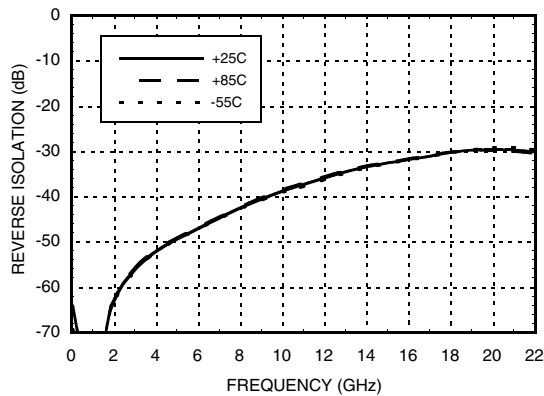

Noise Figure vs. Temperature

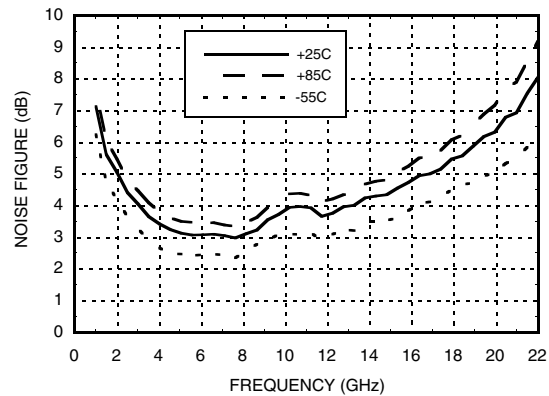

GaAs PHEMT MMIC POWER AMPLIFIER, 2.0 - 20.0 GHz

1

AMPLIFIERS - CHIP

P1dB vs. Temperature

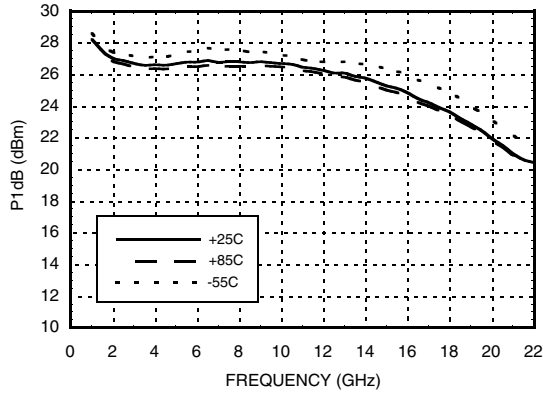

Psat vs. Temperature

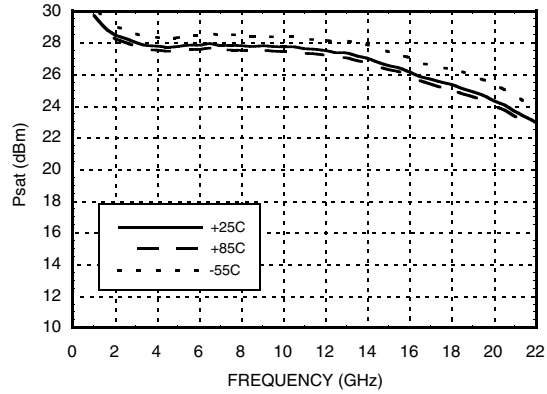

Output IP3 vs. Temperature

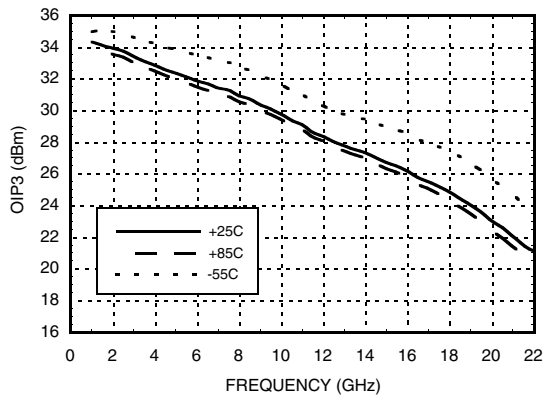

**Gain, Power & OIP3
vs. Supply Voltage @ 10 GHz, Fixed Vgg**

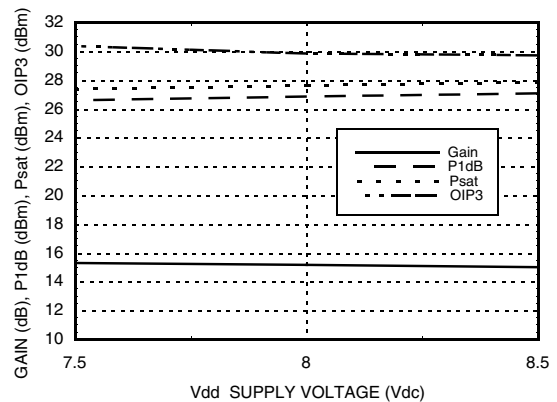

Absolute Maximum Ratings

Drain Bias Voltage (Vdd)	+9.0 Vdc
Gate Bias Voltage (Vgg1)	-2.0 to 0 Vdc
Gate Bias Voltage (Vgg2)	(Vdd - 8.0) Vdc to Vdd
RF Input Power (RFIn)(Vdd = +8.0 Vdc)	+23 dBm
Channel Temperature	175 °C
Continuous Pdiss (T= 85 °C) (derate 51.5 mW/°C above 85 °C)	4.64 W
Thermal Resistance (channel to die bottom)	19.4 °C/W
Storage Temperature	-65 to +150 °C
Operating Temperature	-55 to +85 °C

Typical Supply Current vs. Vdd

Vdd (V)	Idd (mA)
+7.5	292
+8.0	290
+8.5	288

GaAs PHEMT MMIC POWER AMPLIFIER, 2.0 - 20.0 GHz

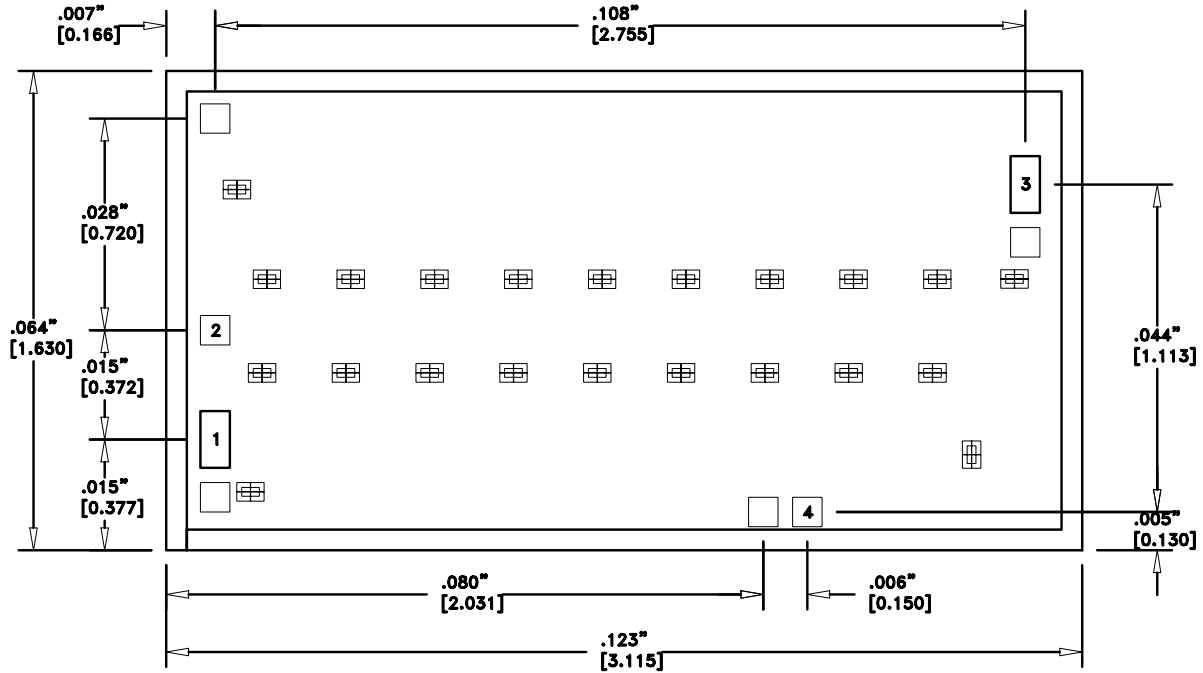

Outline Drawing



NOTES:

1. ALL DIMENSIONS IN INCHES [MILLIMETERS]
2. NO CONNECTION REQUIRED FOR UNLABELED BOND PADS
3. DIE THICKNESS IS 0.004 (0.100)
4. TYPICAL BOND PAD IS 0.004 (0.100) SQUARE
5. BACKSIDE METALLIZATION: GOLD
6. BACKSIDE METAL IS GROUND
7. BOND PAD METALIZATION: GOLD

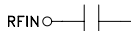
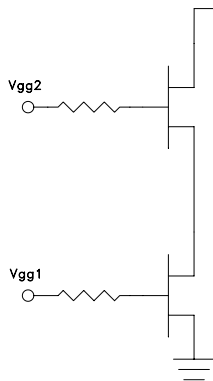
Pad Descriptions

Pad Number	Function	Description	Interface Schematic
1	RFIN	This pad is AC coupled and matched to 50 Ohms from 2.0 - 20.0 GHz	
2	Vgg2	Gate Control 2 for amplifier. +3V should be applied to Vgg2 for nominal operation.	
3	RFOUT & Vdd	RF output for amplifier. Connect the DC bias (Vdd) network to provide drain current (Idd). See application circuit herein.	
4	Vgg1	Gate Control 1 for amplifier. Adjust between -2 to 0V to achieve Idd= 290 mA.	
Die Bottom	GND	Die bottom must be connected to RF/DC ground.	

For price, delivery, and to place orders, please contact Hittite Microwave Corporation:
12 Elizabeth Drive, Chelmsford, MA 01824 Phone: 978-250-3343 Fax: 978-250-3373
Order Online at www.hittite.com

GaAs PHEMT MMIC POWER AMPLIFIER, 2.0 - 20.0 GHz

1

AMPLIFIERS - CHIP

Assembly Diagram

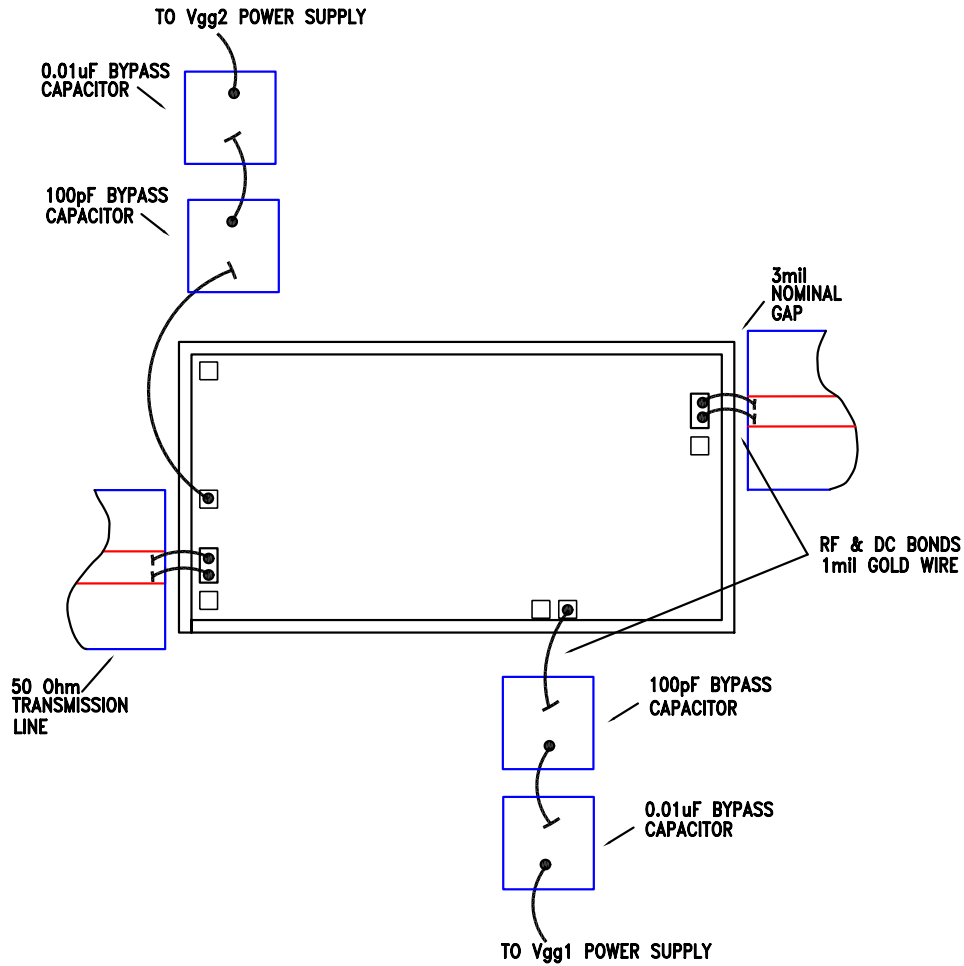

Application Circuit

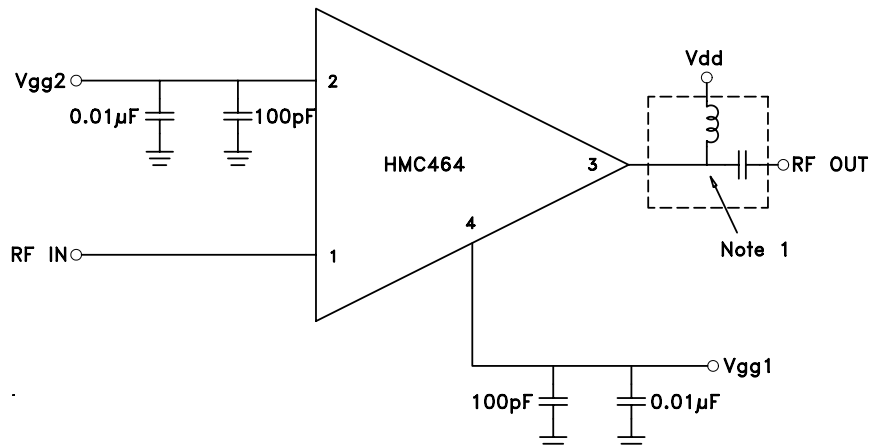

NOTE 1: Drain Bias (V_{dd}) must be applied through a broadband bias tee or external bias network.

For price, delivery, and to place orders, please contact Hittite Microwave Corporation:
12 Elizabeth Drive, Chelmsford, MA 01824 Phone: 978-250-3343 Fax: 978-250-3373
Order Online at www.hittite.com

GaAs PHEMT MMIC POWER AMPLIFIER, 2.0 - 20.0 GHz

Mounting & Bonding Techniques for Millimeterwave GaAs MMICs

The die should be attached directly to the ground plane with conductive epoxy (see HMC general Handling, Mounting, Bonding Note).

50 Ohm Microstrip transmission lines on 0.127mm (5 mil) thick alumina thin film substrates are recommended for bringing RF to and from the chip (Figure 1). If 0.254mm (10 mil) thick alumina thin film substrates must be used, the die should be raised 0.150mm (6 mils) so that the surface of the die is coplanar with the surface of the substrate. One way to accomplish this is to attach the 0.102mm (4 mil) thick die to a 0.150mm (6 mil) thick molybdenum heat spreader (moly-tab) which is then attached to the ground plane (Figure 2).

Microstrip substrates should be brought as close to the die as possible in order to minimize bond wire length. Typical die-to-substrate spacing is 0.076mm to 0.152 mm (3 to 6 mils).

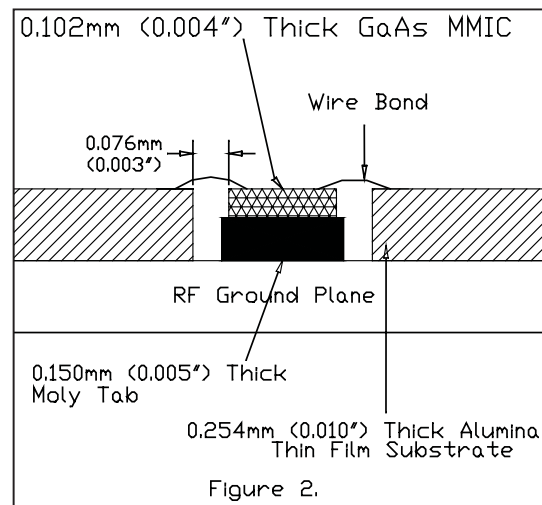
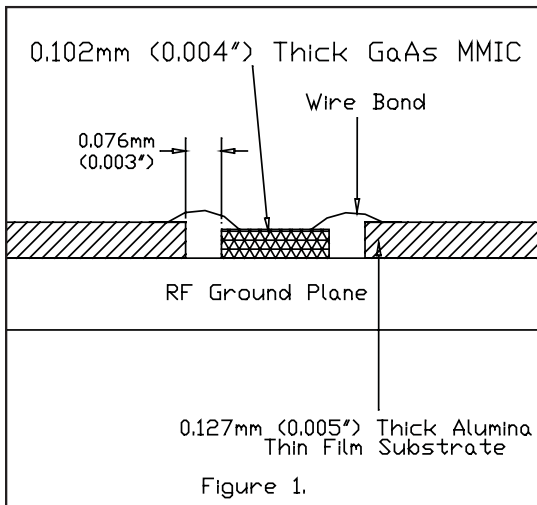

Handling Precautions

Follow these precautions to avoid permanent damage.

Cleanliness: Handle the chips in a clean environment. DO NOT attempt to clean the chip using liquid cleaning systems.

Static Sensitivity: Follow ESD precautions to protect against > ± 250V ESD strikes.

Transients: Suppress instrument and bias supply transients while bias is applied. Use shielded signal and bias cables to minimize inductive pick-up.

General Handling: Handle the chip along the edges with a vacuum collet or with a sharp pair of bent tweezers. The surface of the chip has fragile air bridges and should not be touched with vacuum collet, tweezers, or fingers.

Mounting

The chip is back-metallized and can be die mounted with electrically conductive epoxy. The mounting surface should be clean and flat.

Epoxy Die Attach: Apply a minimum amount of epoxy to the mounting surface so that a thin epoxy fillet is observed around the perimeter of the chip once it is placed into position. Cure epoxy per the manufacturer's schedule.

Wire Bonding

Ball or wedge bond with 0.025mm (1 mil) diameter pure gold wire. Thermosonic wirebonding with a nominal stage temperature of 150 deg. C and a ball bonding force of 40 to 50 grams or wedge bonding force of 18 to 22 grams is recommended. Use the minimum level of ultrasonic energy to achieve reliable wirebonds. Wirebonds should be started on the chip and terminated on the package or substrate. All bonds should be as short as possible <0.31mm (12 mils).