

MECHANICAL DATA

**GOLD METALLISED  
MULTI-PURPOSE SILICON  
DMOS RF FET  
150W – 28V – 175MHz  
PUSH-PULL**

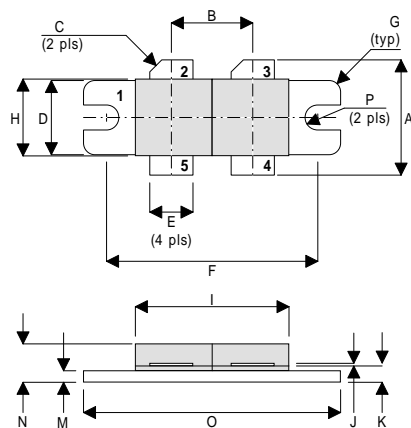

DR

PIN 1 SOURCE (COMMON)      PIN 2 DRAIN 1  
 PIN 3 DRAIN 2                      PIN 4 GATE 2  
 PIN 5 GATE 1

DIM	Millimetres	Tol.	Inches	Tol.
A	19.05	0.50	0.75	0.020
B	10.77	0.13	0.424	0.005
C	45°	5°	45°	5°
D	9.78	0.13	0.385	0.005
E	5.71	0.13	0.225	0.005
F	27.94	0.13	1.100	0.005
G	1.52R	0.13	0.060R	0.005
H	10.16	0.13	0.400	0.005
I	22.22	MAX	0.875	MAX
J	0.13	0.02	0.005	0.001
K	2.72	0.13	0.107	0.005
M	1.70	0.13	0.067	0.005
N	5.08	0.50	0.200	0.020
O	34.03	0.13	1.340	0.005
P	1.57R	0.08	0.062R	0.003

FEATURES

- SIMPLIFIED AMPLIFIER DESIGN
- SUITABLE FOR BROAD BAND APPLICATIONS
- LOW  $C_{rss}$
- SIMPLE BIAS CIRCUITS
- LOW NOISE
- HIGH GAIN – 13 dB MINIMUM

APPLICATIONS

- VHF/UHF COMMUNICATIONS  
from 1 MHz to 200 MHz

ABSOLUTE MAXIMUM RATINGS ( $T_{case} = 25^{\circ}C$  unless otherwise stated)

$P_D$	Power Dissipation	438W
$BV_{DSS}$	Drain – Source Breakdown Voltage	70V
$BV_{GSS}$	Gate – Source Breakdown Voltage	$\pm 20V$
$I_{D(sat)}$	Drain Current	30A
$T_{stg}$	Storage Temperature	-65 to 150°C
$T_j$	Maximum Operating Junction Temperature	200°C

## ELECTRICAL CHARACTERISTICS (T<sub>case</sub> = 25°C unless otherwise stated)

Parameter	Test Conditions	Min.	Typ.	Max.	Unit
<b>PER SIDE</b>					
B <sub>V</sub> DSS	Drain–Source Breakdown Voltage	V <sub>GS</sub> = 0	I <sub>D</sub> = 100mA	70	V
I <sub>DSS</sub>	Zero Gate Voltage Drain Current	V <sub>DS</sub> = 28V	V <sub>GS</sub> = 0		6 mA
I <sub>GSS</sub>	Gate Leakage Current	V <sub>GS</sub> = 20V	V <sub>DS</sub> = 0		1 μA
V <sub>GS(th)</sub>	Gate Threshold Voltage*	I <sub>D</sub> = 10mA	V <sub>DS</sub> = V <sub>GS</sub>	1	7 V
g <sub>fs</sub>	Forward Transconductance*	V <sub>DS</sub> = 10V	I <sub>D</sub> = 6A	4.8	mhos
V <sub>GS(th)match</sub>	Gate Threshold Voltage Matching Between Sides	I <sub>D</sub> = 10mA	V <sub>DS</sub> = V <sub>GS</sub>		0.1 V
<b>TOTAL DEVICE</b>					
G <sub>PS</sub>	Common Source Power Gain	P <sub>O</sub> = 150W		13	dB
η	Drain Efficiency	V <sub>DS</sub> = 28V	I <sub>DQ</sub> = 2.4A	50	%
VSWR	Load Mismatch Tolerance	f = 175MHz		20:1	—
<b>PER SIDE</b>					
C <sub>iss</sub>	Input Capacitance	V <sub>DS</sub> = 28V	V <sub>GS</sub> = -5V f = 1MHz		360 pF
C <sub>oss</sub>	Output Capacitance	V <sub>DS</sub> = 28V	V <sub>GS</sub> = 0 f = 1MHz		180 pF
C <sub>rss</sub>	Reverse Transfer Capacitance	V <sub>DS</sub> = 28V	V <sub>GS</sub> = 0 f = 1MHz		15 pF

\* Pulse Test: Pulse Duration = 300 μs , Duty Cycle ≤ 2%

## HAZARDOUS MATERIAL WARNING

The ceramic portion of the device between leads and metal flange is beryllium oxide. Beryllium oxide dust is highly toxic and care must be taken during handling and mounting to avoid damage to this area.

**THESE DEVICES MUST NEVER BE THROWN AWAY WITH GENERAL INDUSTRIAL OR DOMESTIC WASTE.**

## THERMAL DATA

R <sub>THj-case</sub>	Thermal Resistance Junction – Case	Max. 0.4°C / W
-----------------------	------------------------------------	----------------

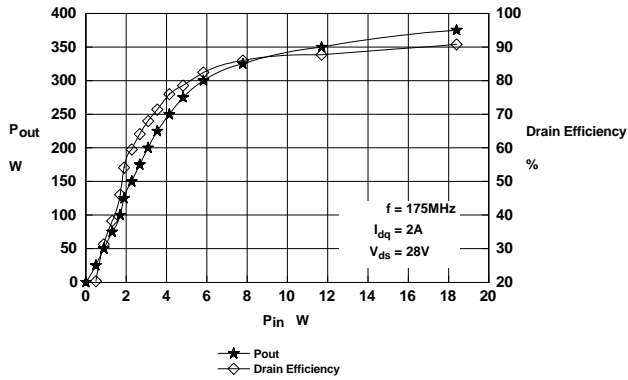

Figure 1 – Power Output and Efficiency vs. Power Input.

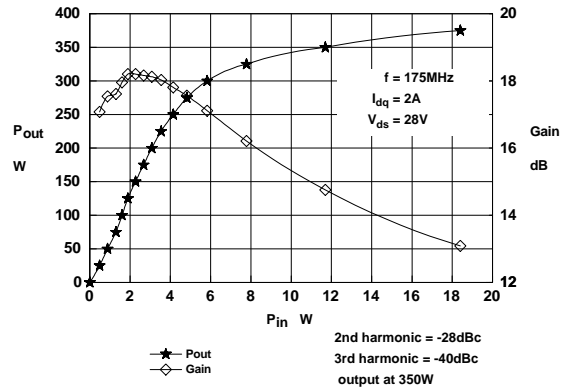

Figure 2 – Power Output & Gain vs. Power Input.

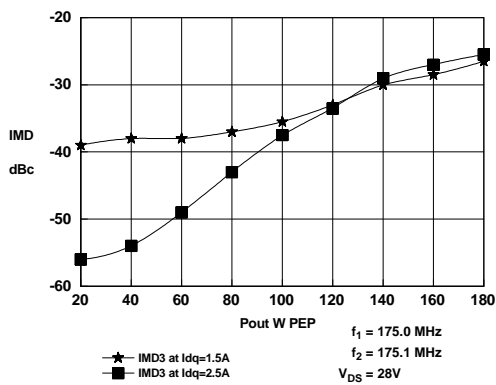

Figure 3 – IMD vs. Output Power.

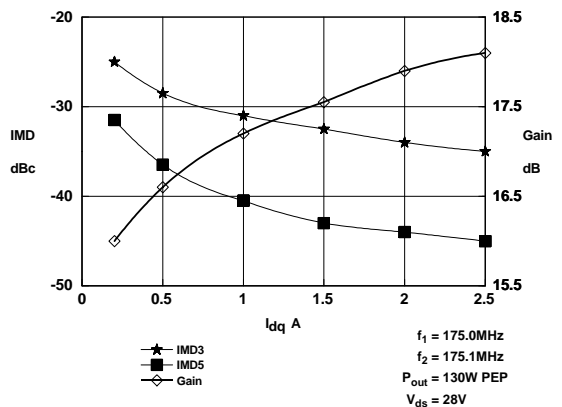
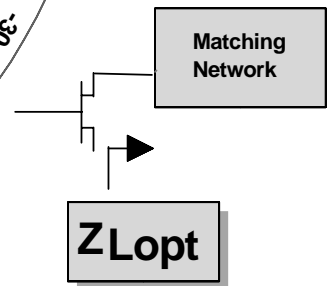
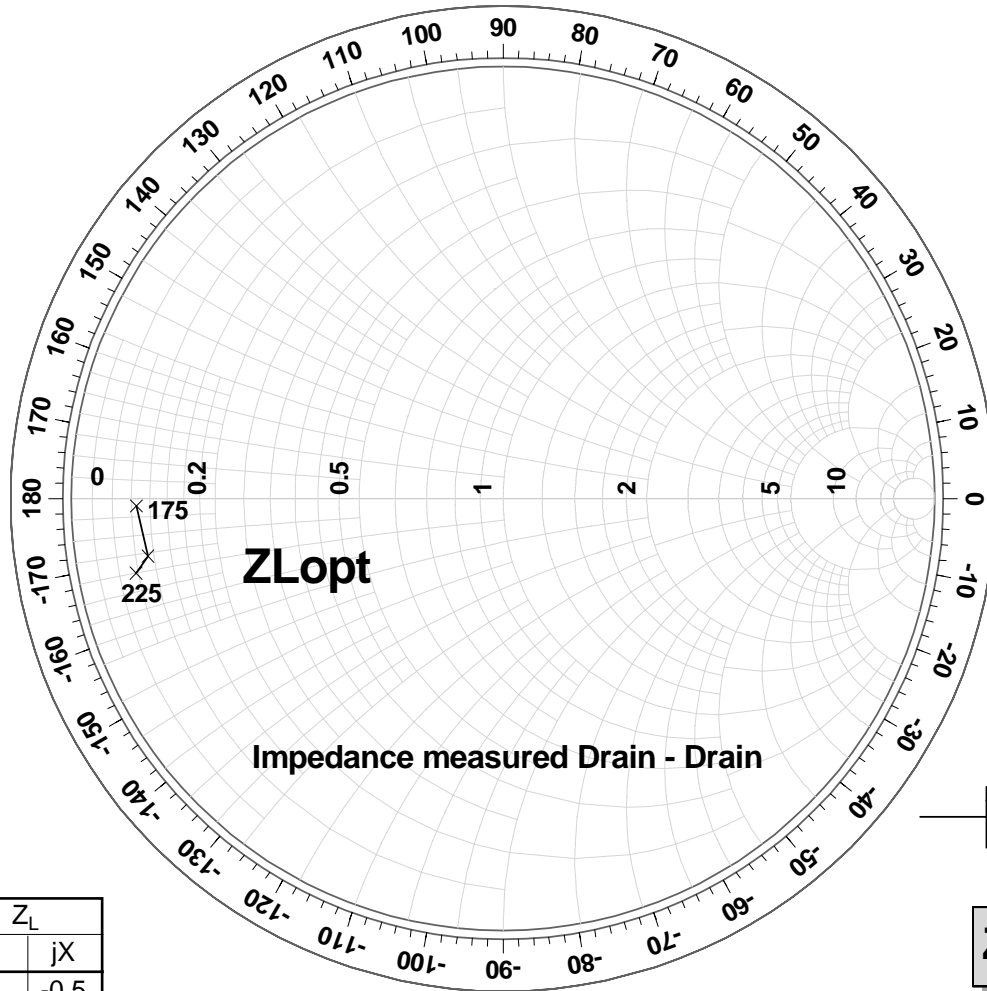
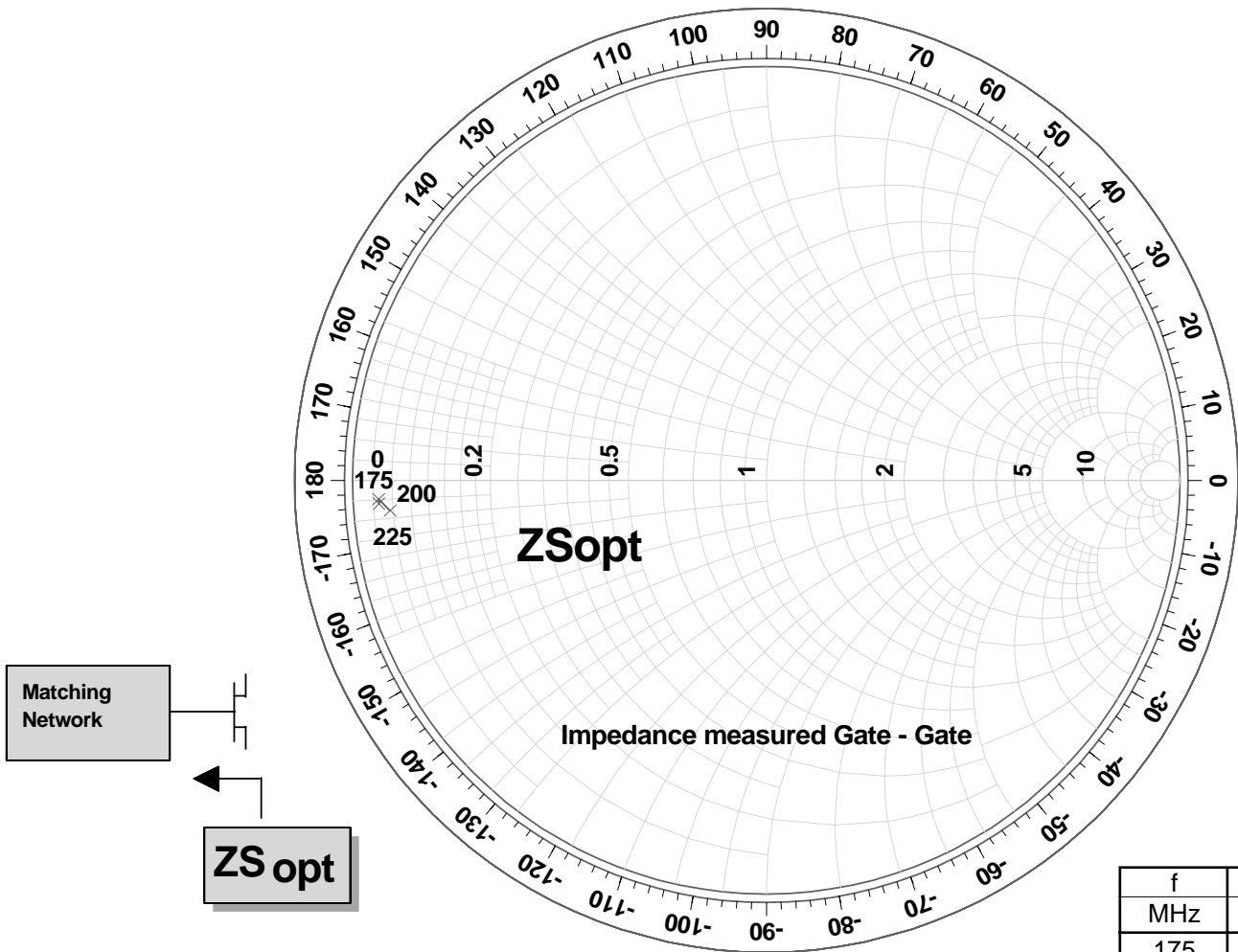
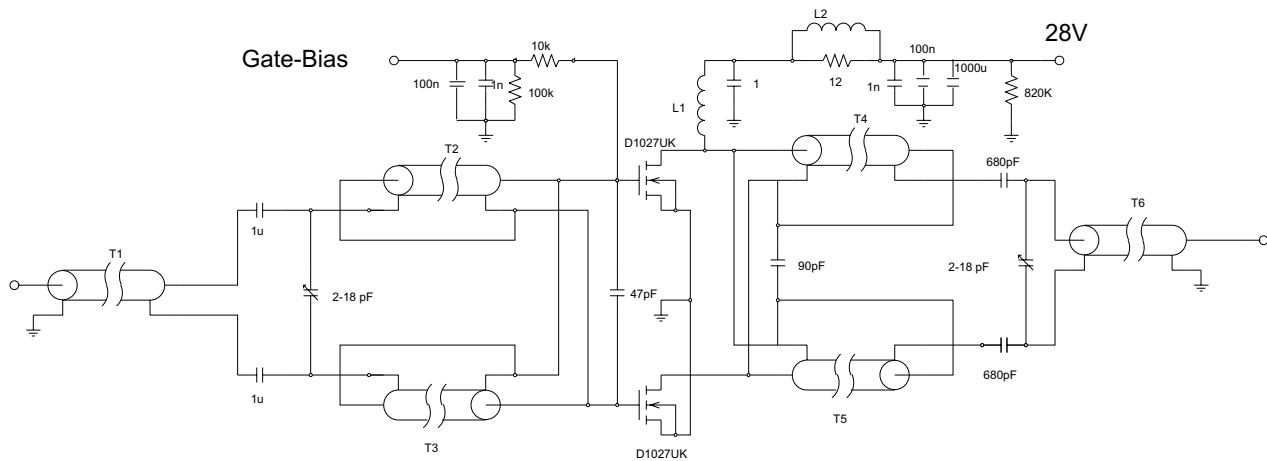

Figure 4 – IMD & Gain vs. Idq



f	Z <sub>L</sub>	
	R	jX
175	4	-0.5
200	4.5	-4
225	3.5	-5





## D1027UK 175MHz TEST FIXTURE

- T1,2,3** 7cm Storm Products EXE18 19/30 S1TW coaxial cable on Siemens A1 x 1 2-hole core.
- T4,5** 14cm Storm Products EXE18 19/30 S1TW coaxial cable.
- T6** 11cm Storm Products EXE18 19/30 S1TW coaxial cable
- L1** 6 turns 1.2mm dia wire, 5mm internal diameter
- L2** 1.5 turns 0.9mm dia wire on Siemens A1 x 1 2 hole core