2SJ479(L), 2SJ479(S)

Silicon P Channel DV-L MOS FET
High Speed Power Switching

HITACHI

ADE-208-541
1st. Edition

Features

- Low on-resistance
 $R_{DS(on)} = 25 \text{ m}\Omega$ typ.
- 4V gate drive devices.
- High speed switching

Outline

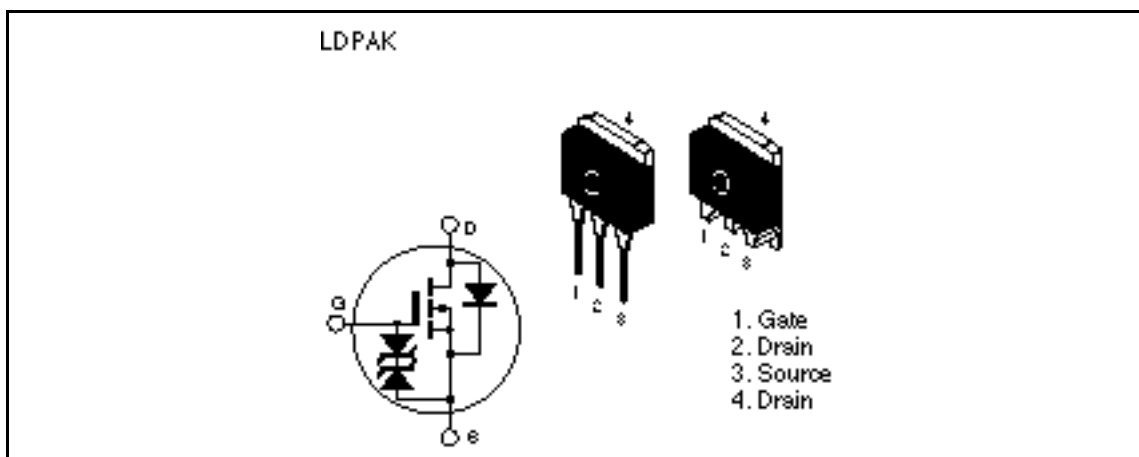

2SJ479(L), 2SJ479(S)

Absolute Maximum Ratings (Ta = 25°C)

Item	Symbol	Ratings	Unit
Drain to source voltage	V_{DSS}	-30	V
Gate to source voltage	V_{GSS}	±20	V
Drain current	I_D	-30	A
Drain peak current	$I_{D(pulse)}$ ^{Note1}	-120	A
Body to drain diode reverse drain current	I_{DR}	-30	A
Channel dissipation	Pch ^{Note2}	50	W
Channel temperature	Tch	150	°C
Storage temperature	$Tstg$	-55 to +150	°C

Notes: 1. PW = 10µs, duty cycle = 1 %

2. Value at Tc = 25°C

Electrical Characteristics (Ta = 25°C)

Item	Symbol	Min	Typ	Max	Unit	Test Conditions
Drain to source breakdown voltage	$V_{(BR)DSS}$	-30	—	—	V	$I_D = -10mA, V_{GS} = 0$
Gate to source breakdown voltage	$V_{(BR)GSS}$	±20	—	—	V	$I_G = ±100µA, V_{DS} = 0$
Zero gate voltage drain current	I_{DSS}	—	—	-10	µA	$V_{DS} = -30V, V_{GS} = 0$
Gate to source leak current	I_{GSS}	—	—	±10	µA	$V_{GS} = ±16V, V_{DS} = 0$
Gate to source cutoff voltage	$V_{GS(off)}$	-1.0	—	-2.0	V	$I_D = -1mA, V_{DS} = -10V$
Static drain to source on state resistance	$R_{DS(on)}$	—	25	35	m	$I_D = -15A, V_{GS} = -10V$ ^{Note3}
	$R_{DS(on)}$	—	40	60	m	$I_D = -15A, V_{GS} = -4V$ ^{Note3}
Forward transfer admittance	$ y_{fs} $	12	20	—	S	$I_D = -15A, V_{DS} = -10V$ ^{Note3}
Input capacitance	C_{iss}	—	1700	—	pF	$V_{DS} = -10V$
Output capacitance	C_{oss}	—	950	—	pF	$V_{GS} = 0$
Reverse transfer capacitance	C_{rss}	—	260	—	pF	f = 1MHz
Turn-on delay time	$t_{d(on)}$	—	20	—	ns	$V_{GS} = -10V, I_D = -15A$
Rise time	t_r	—	290	—	ns	$R_L = 0.67$
Turn-off delay time	$t_{d(off)}$	—	170	—	ns	
Fall time	t_f	—	130	—	ns	
Body to drain diode forward voltage	V_{DF}	—	-1.1	—	V	$I_F = -30A, V_{GS} = 0$
Body to drain diode reverse recovery time	t_{rr}	—	70	—	ns	$I_F = -30A, V_{GS} = 0$ diF/ dt = 50A/µs

Note: 3. Pulse test

Main Characteristics

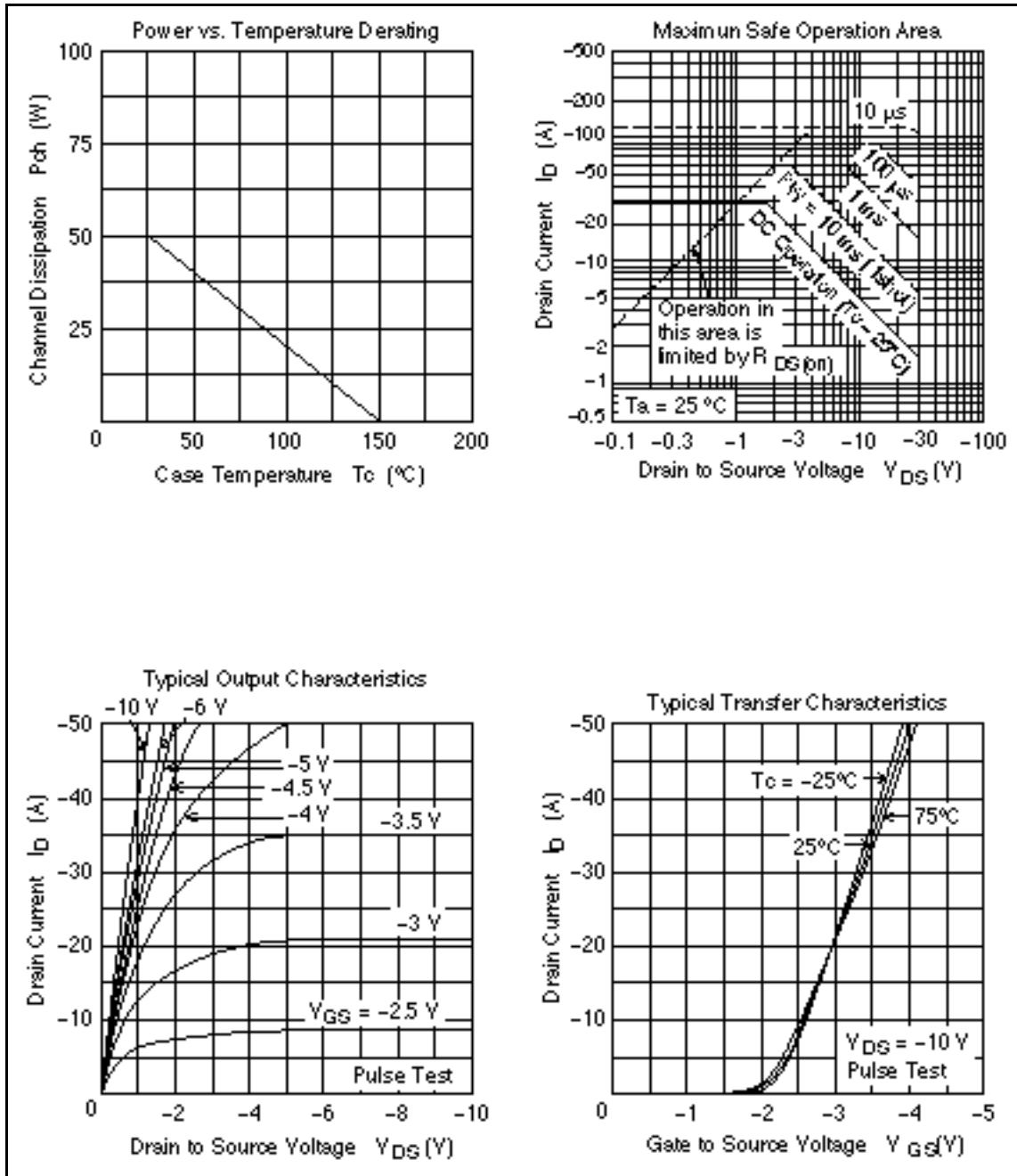

2SJ479(L), 2SJ479(S)

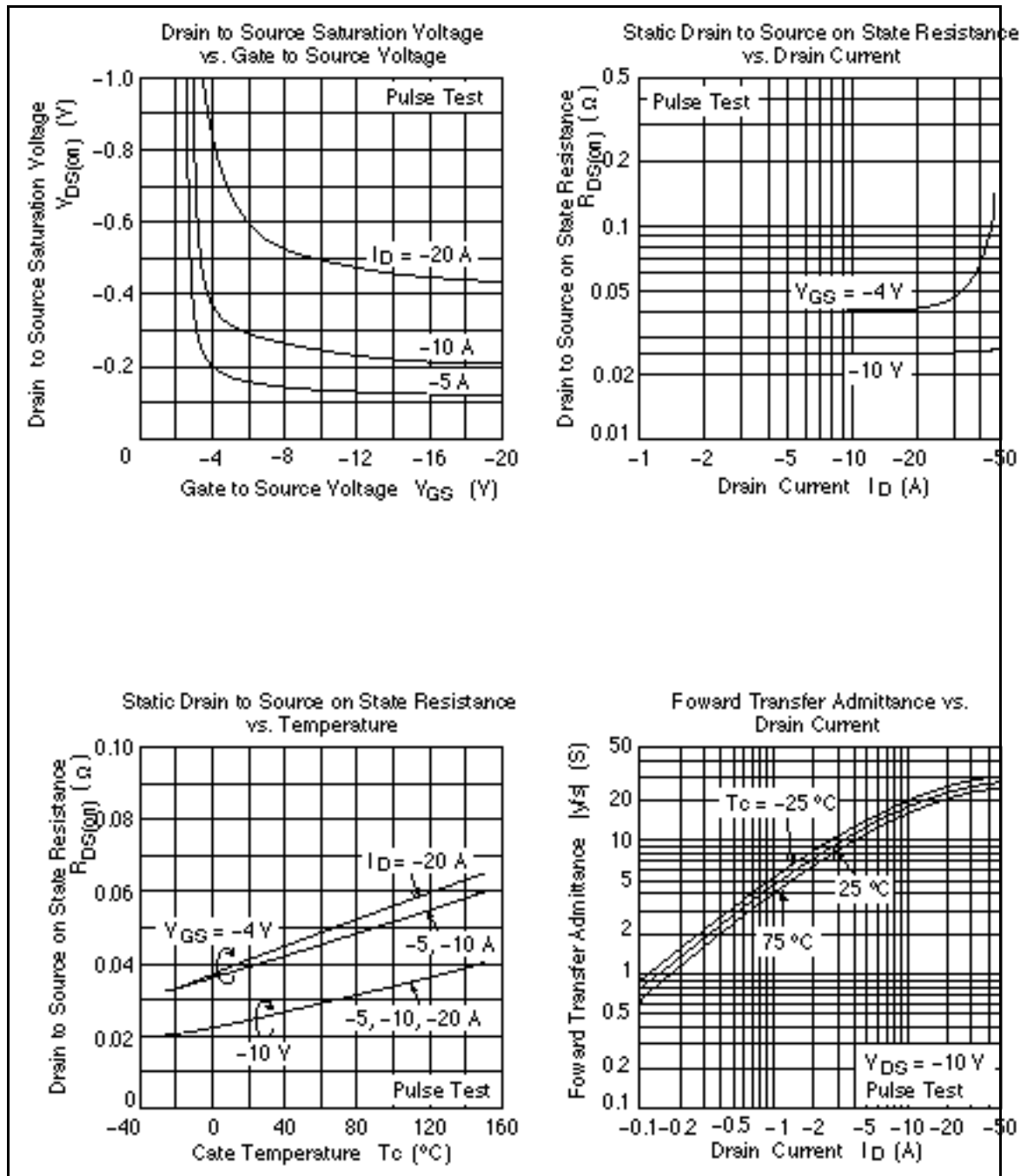

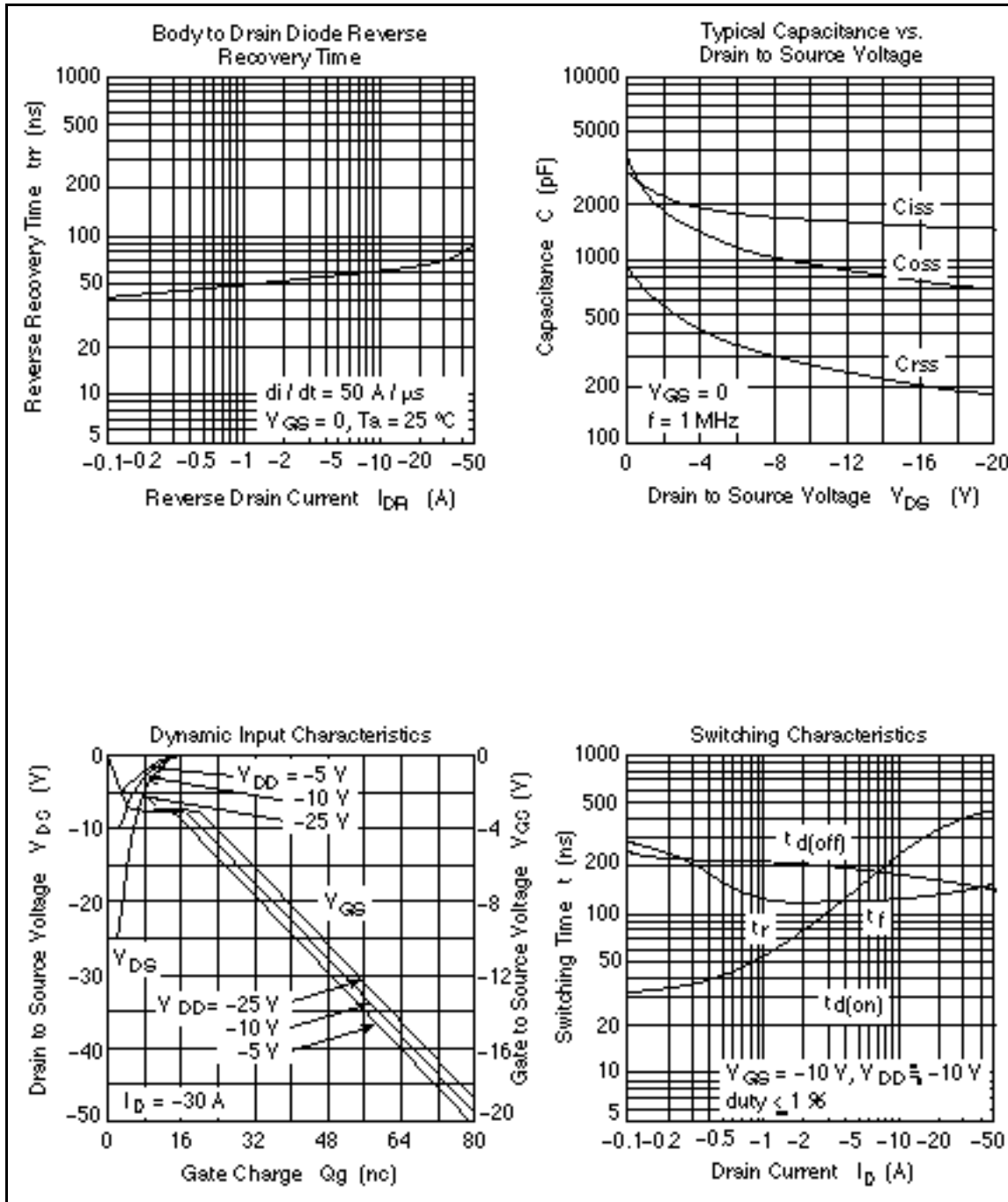

2SJ479(L), 2SJ479(S)

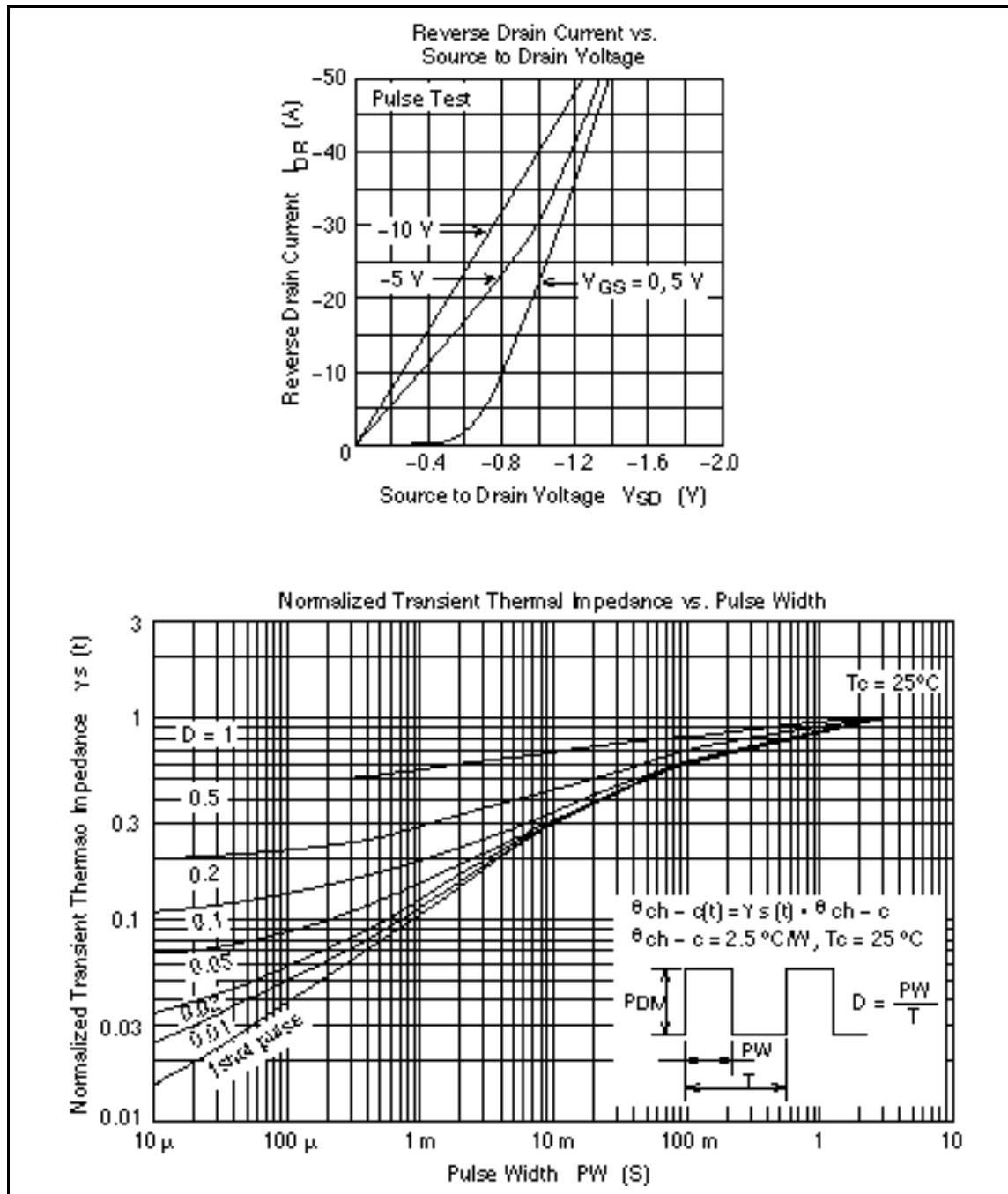

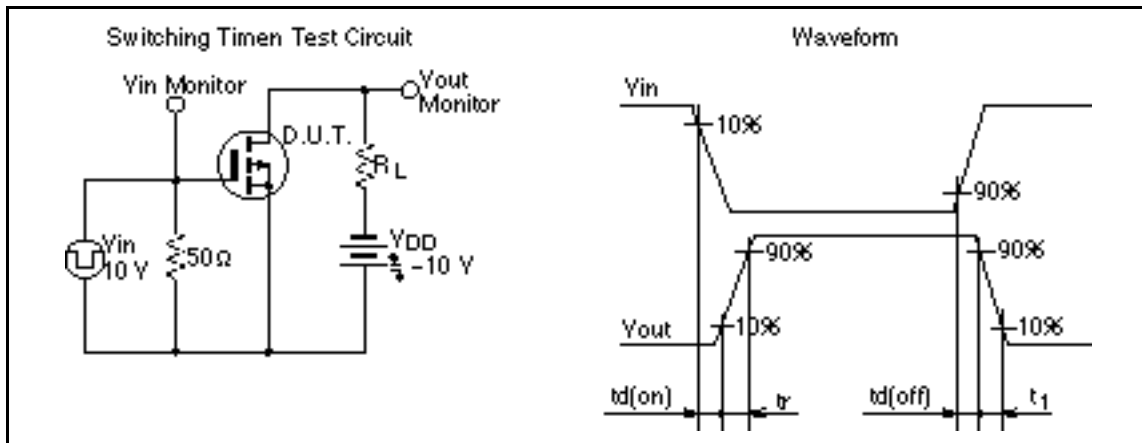

2SJ479(L), 2SJ479(S)

Package Dimensions

Unit: mm

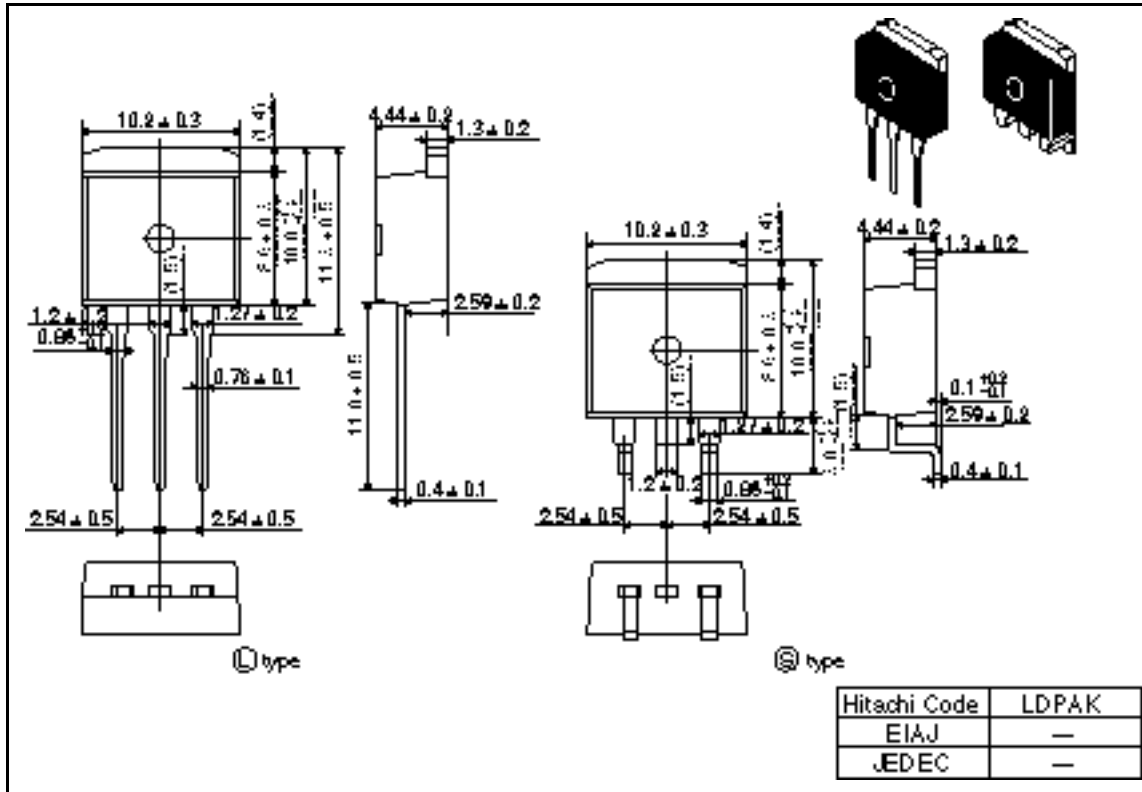

When using this document, keep the following in mind:

1. This document may, wholly or partially, be subject to change without notice.
2. All rights are reserved: No one is permitted to reproduce or duplicate, in any form, the whole or part of this document without Hitachi's permission.
3. Hitachi will not be held responsible for any damage to the user that may result from accidents or any other reasons during operation of the user's unit according to this document.
4. Circuitry and other examples described herein are meant merely to indicate the characteristics and performance of Hitachi's semiconductor products. Hitachi assumes no responsibility for any intellectual property claims or other problems that may result from applications based on the examples described herein.
5. No license is granted by implication or otherwise under any patents or other rights of any third party or Hitachi, Ltd.
6. **MEDICAL APPLICATIONS:** Hitachi's products are not authorized for use in **MEDICAL APPLICATIONS** without the written consent of the appropriate officer of Hitachi's sales company. Such use includes, but is not limited to, use in life support systems. Buyers of Hitachi's products are requested to notify the relevant Hitachi sales offices when planning to use the products in **MEDICAL APPLICATIONS**.

HITACHI

Hitachi, Ltd.

Semiconductor & IC Div.

Nippon Bldg., 2-6-2, Ohia-machi, Chiyoda-ku, Tokyo 100, Japan

Tel Tokyo (03) 3270-2111

Fax (03) 3270-5109

For further information write to:

Hitachi America, Ltd.

Semiconductor & IC Div.

2000 Sierra Point Parkway

Brea, CA, 94005-4935

U.S.A.

Tel 415-589-8300

Fax 415-589-4207

Hitachi Europe GmbH

Electronic Components Group

Continental Europe

Dornacher Straße 3

D-85632 Feldkirchen

München

Tel 089-9 91 80-0

Fax 089-9 29 30 00

Hitachi Europe Ltd.

Electronic Components Div.

Northern Europe Headquarters

Whitebrook Park

Lower Cookham Road

Midlehead

Berkshire SL6 5YA

United Kingdom

Tel 0628-885000

Fax 0628-778322

Hitachi Asia Pte. Ltd.

#6 Collyer Quay #20-00

Hitachi Tower

Singapore 0404

Tel 535-2100

Fax 535-1533

Hitachi Asia (Hong Kong) Ltd.

Unit 706, North Tower,

World Finance Centre

Harbour City, Canton Road

Tsim Sha Tsui, Kowloon

Hong Kong

Tel 27359218

Fax 27308074

Copyright ©Hitachi, Ltd., 1997. All rights reserved. Printed in Japan.