

FEATURES

- **Guaranteed CTR Symmetry, 2:1 Maximum**
- **Bidirectional AC Input**
- **Industry Standard SOIC-8 Surface**
- **Mountable Package**
- **Standard Lead Spacing, .05"**
- **Available in Tape and Reel Option (Conforms to EIA Standard RS481A)**

DESCRIPTION

The IL256A is an AC input phototransistor optocoupler. The device consists of two infrared emitters connected in anti-parallel and coupled to a silicon NPN phototransistor detector.

These circuit elements are constructed with a standard SOIC-8 foot print.

The product is well suited for telecom applications such as ring detection or off/on hook status, given its bidirectional LED input and guaranteed current transfer ratio (CTR) minimum of 20% at $I_F = 10$ mA.

Maximum Ratings

Emitter

Continuous Forward Current..... 60 mA
Power Dissipation at 25°C 90 mW
Derate Linearly from 25°C 0.8 mW/°C

Detector

Collector-Emitter Breakdown Voltage 30 V
Emitter-Collector Breakdown Voltage 5 V
Collector-Base Breakdown Voltage 70 V
Power Dissipation 150 mW
Derate Linearly from 25°C 2.0 mW/°C

Package

Total Package Dissipation at 25°C Ambient
(LED + Detector) 240 mW
Derate Linearly from 25°C 3.1 mW/°C
Storage Temperature -55°C to +150°C
Operating Temperature -55°C to +100°C
Soldering Time at 260°C..... 10 sec.

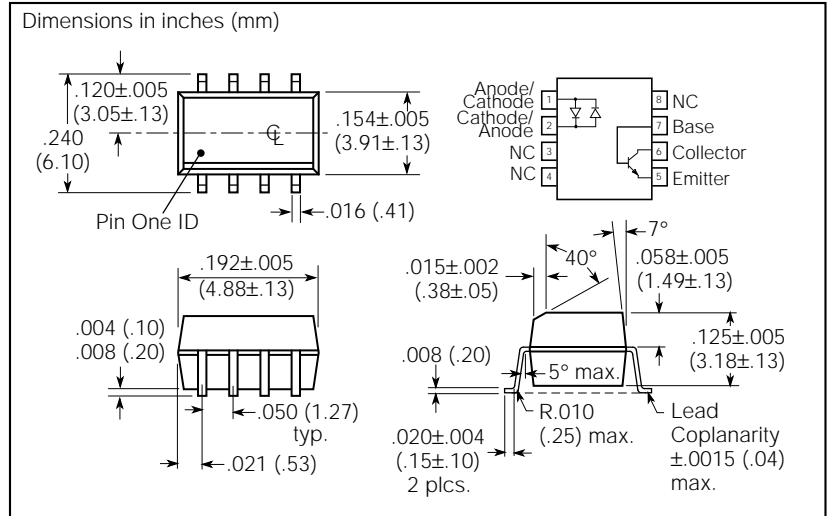

Characteristics ($T_A = 25^\circ\text{C}$)

	Sym- bol	Min.	Typ.	Max.	Unit	Condition
Emitter						
Forward Voltage	V_F		1.2	1.5	V	$I_F = \pm 10$ mA
Detector						
Breakdown Voltage						
Collector-Emitter	BV_{CEO}	30	50		V	$I_C = 1$ mA
Emitter-Collector	BV_{ECO}	5	10		V	$I_E = 100$ μ A
Collector-Base	BV_{CBO}	70	90		V	$I_C = 100$ μ A
Leakage Current, Collector-Emitter	I_{CEO}		5	50	nA	$V_{CE} = 10$ V
Package						
DC Current Transfer Ratio	CTR	20			%	$I_F = \pm 10$ mA, $V_{CE} = 5$ V
Symmetry CTR at +10mA CTR at -10 mA		0.5	1.0	2.0		
Saturation Voltage, Collector-Emitter	V_{CESat}			0.4		$I_F = \pm 16$ mA, $I_C = 2$ mA
Isolation Voltage, Input to Output	V_{IO}	2500			VAC _{RMS}	

Figure 1. LED forward current versus forward voltage

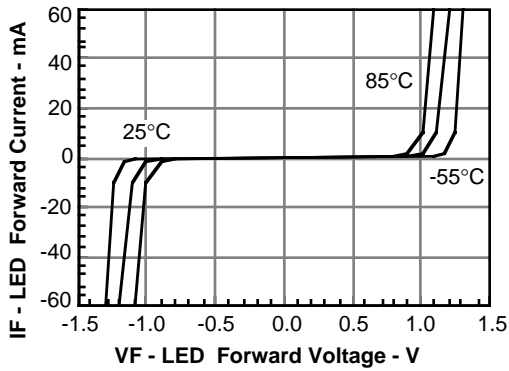

Figure 2. Forward voltage versus forward current

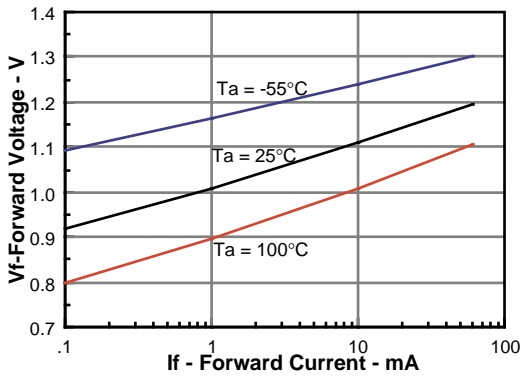

Figure 3. Peak LED current versus duty factor, Tau

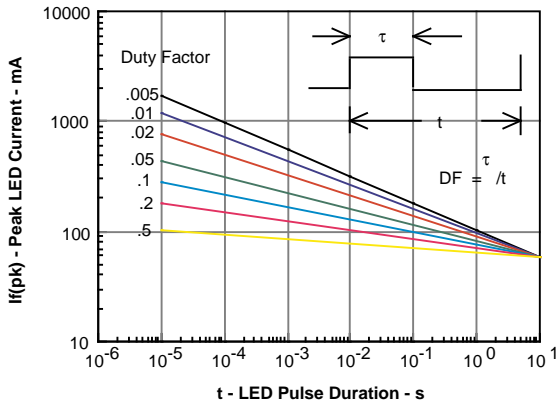

Figure 4. Normalized CTR versus If and Ta

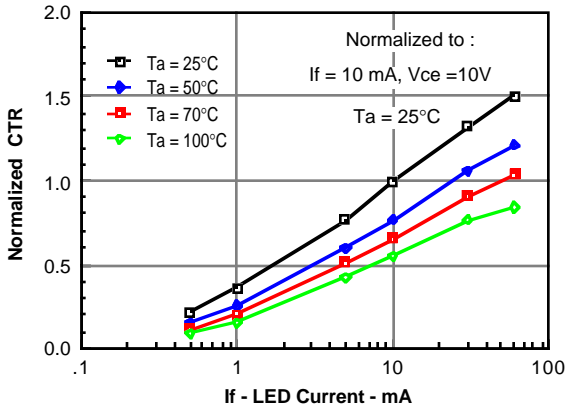

Figure 5. Normalized saturated CTR

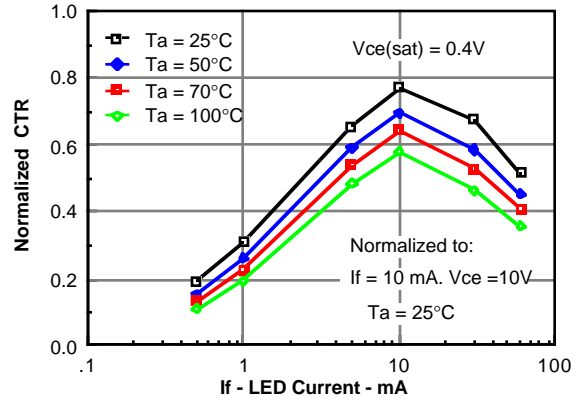

Figure 6. Normalized CTRcb

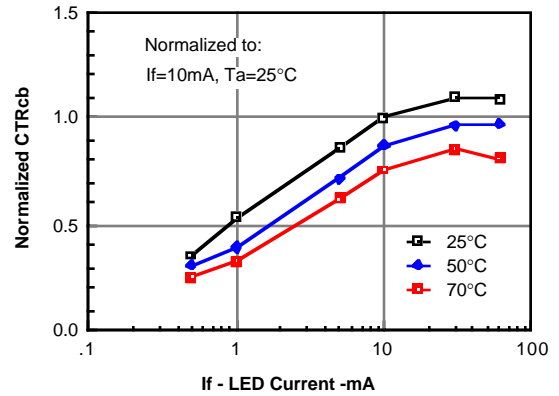

Figure 7. Photocurrent versus LED current

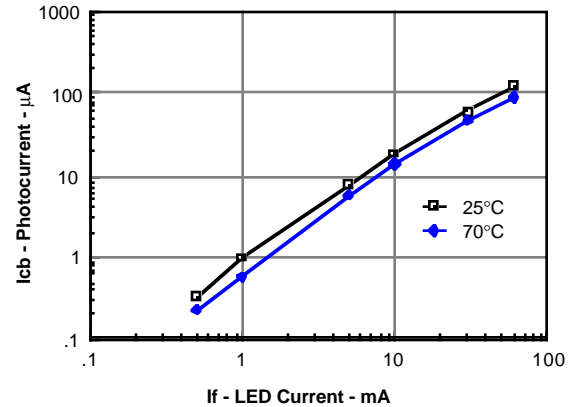

Figure 8. Base current versus If and HFE

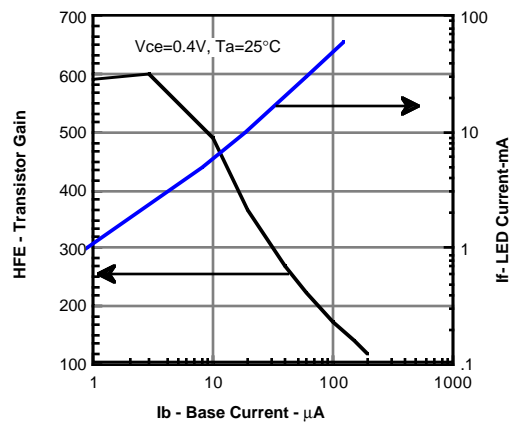

Figure 9. Normalized HFE versus I_b , T_a

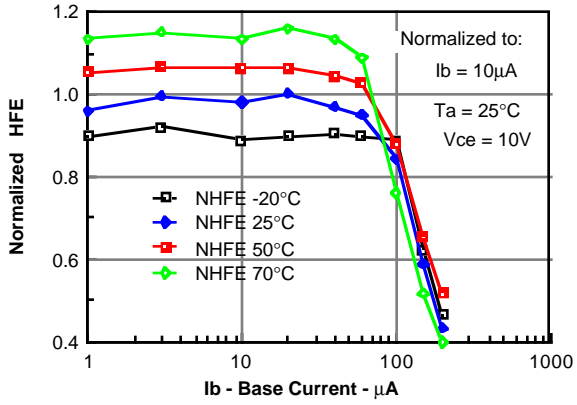

Figure 11. Base emitter voltage versus base current

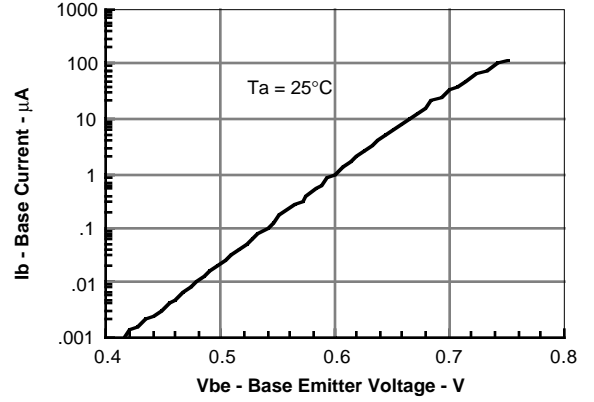

Figure 10. Normalized saturated HFE versus I_b

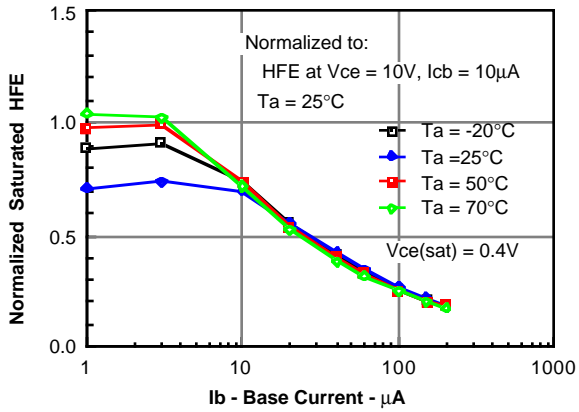

Figure 12. Collector-emitter leakage current versus temperature

