

APT6060AN 600V 11.5A 0.60 Ω
 APT5560AN 550V 11.5A 0.60 Ω
 APT6070AN 600V 10.5A 0.70 Ω
 APT5570AN 550V 10.5A 0.70 Ω

POWER MOS IV™

N - CHANNEL ENHANCEMENT MODE HIGH VOLTAGE POWER MOSFETS

MAXIMUM RATINGS

All Ratings: $T_C = 25^\circ\text{C}$ unless otherwise specified.

Symbol	Parameter	APT				UNIT
		5560AN	6060AN	5570AN	6070AN	
V_{DSS}	Drain-Source Voltage	550	600	550	600	Volts
I_D	Continuous Drain Current	11.5		10.5		Amps
I_{DM}	Pulsed Drain Current ¹	46		42		Amps
V_{GS}	Gate-Source Voltage	±30				Volts
P_D	Total Power Dissipation @ $T_C = 25^\circ\text{C}$, Derate Above 25°C	198				Watts
T_J, T_{STG}	Operating and Storage Junction Temperature Range	- 55 to 150				°C

STATIC ELECTRICAL CHARACTERISTICS

Symbol	Characteristic / Test Conditions / Part Number	MIN	TYP	MAX	UNIT	
BV_{DSS}	Drain-Source Breakdown Voltage ($V_{GS} = 0V, I_D = 250 \mu\text{A}$)	APT6060AN / APT6070AN		600	Volts	
		APT5560AN / APT5570AN		550	Volts	
I_{DSS}	Zero Gate Voltage Drain Current ($V_{DS} = V_{DSS}, V_{GS} = 0V$) ($V_{DS} = 0.8 V_{DSS}, V_{GS} = 0V, T_C = 125^\circ\text{C}$)				250	μA
					1000	
I_{GSS}	Gate-Source Leakage Current ($V_{GS} = \pm 30V, V_{DS} = 0V$)				±100	nA
$I_D(ON)$	On State Drain Current ² ($V_{DS} > I_D(ON) \times R_{DS(ON)}$ Max, $V_{GS} = 10V$)	APT6060AN / APT5560AN		11.5	Amps	
		APT6070AN / APT5570AN		10.5	Amps	
$V_{GS(TH)}$	Gate Threshold Voltage ($V_{DS} = V_{GS}, I_D = 1\text{mA}$)	2		4	Volts	
$R_{DS(ON)}$	Static Drain-Source On-State Resistance ² ($V_{GS} = 10V, I_D = 0.5 I_D(\text{Cont.})$)	APT6060AN / APT5560AN			0.60	Ohms
		APT6070AN / APT5570AN			0.70	Ohms

THERMAL CHARACTERISTICS

Symbol	Characteristic	MIN	TYP	MAX	UNIT
$R_{\theta JC}$	Junction to Case			0.63	°C/W
$R_{\theta JA}$	Junction to Ambient			30	°C/W
T_L	Max. Lead Temp. for Soldering Conditions: 0.063" from Case for 10 Sec.			300	°C

405 S.W. COLUMBIA STREET
 BEND, OREGON 97702-1035
 U.S.A.

PHONE . . . (503) 382-8028

FAX (503) 388-0364

Symbol	Characteristic	Test Conditions	MIN	TYP	MAX	UNIT
C_{iss}	Input Capacitance	$V_{GS} = 0V$ $V_{DS} = 25V$ $f = 1 \text{ MHz}$		1510	1800	pF
C_{oss}	Output Capacitance			280	390	pF
C_{rss}	Reverse Transfer Capacitance			105	157	pF
Q_g	Total Gate Charge ³	$V_{GS} = 10V, I_D = I_D [\text{Cont.}]$ $V_{DD} = 0.5 V_{DSS}$		66	105	nC
Q_{gs}	Gate-Source Charge			8	12	nC
Q_{gd}	Gate-Drain ("Miller") Charge			35	53	nC
$t_d(\text{on})$	Turn-on Delay Time	$V_{DD} = 0.5 V_{DSS}$ $I_D = I_D [\text{Cont.}], V_{GS} = 15V$ $R_G = 1.8\Omega$		13	25	ns
t_r	Rise Time			18	35	ns
$t_d(\text{off})$	Turn-off Delay Time			51	77	ns
t_f	Fall Time			21	41	ns

SOURCE-DRAIN DIODE RATINGS AND CHARACTERISTICS

Symbol	Characteristic / Test Conditions / Part Number	MIN	TYP	MAX	UNIT
I_S	Continuous Source Current (Body Diode)	APT6060AN / APT5560AN		11.5	Amps
		APT6070AN / APT5570AN		10.5	Amps
I_{SM}	Pulsed Source Current ¹ (Body Diode)	APT6060AN / APT5560AN		46	Amps
		APT6070AN / APT5570AN		42	Amps
V_{SD}	Diode Forward Voltage ² ($V_{GS} = 0V, I_S = -I_D [\text{Cont.}]$)			1.3	Volts
t_{rr}	Reverse Recovery Time ($I_S = -I_D [\text{Cont.}], di_S/dt = 100A/\mu s$)	148	297	594	ns
Q_{rr}	Reverse Recovery Charge	2	4	8	μC

SAFE OPERATING AREA CHARACTERISTICS

Symbol	Characteristic	Test Conditions / Part Number	MIN	TYP	MAX	UNIT
SOA1	Safe Operating Area	$V_{DS} = 0.4 V_{DSS}, I_{DS} = P_D / 0.4 V_{DSS}, t = 1 \text{ Sec.}$	198			Watts
SOA2	Safe Operating Area	$I_{DS} = I_D [\text{Cont.}], V_{DS} = P_D / I_D [\text{Cont.}], t = 1 \text{ Sec.}$	198			Watts
I_{LM}	Inductive Current Clamped	APT6060AN / APT5560AN		46		Amps
		APT6070AN / APT5570AN		42		Amps

- 1.) Repetitive Rating: Pulse width limited by maximum junction temperature. See Transient Thermal Impedance Curve. (Fig. 1)
- 2.) Pulse Test: Pulse width < 380 μs
Duty Cycle < 2%
- 3.) See MIL-STD-750 Method 3471

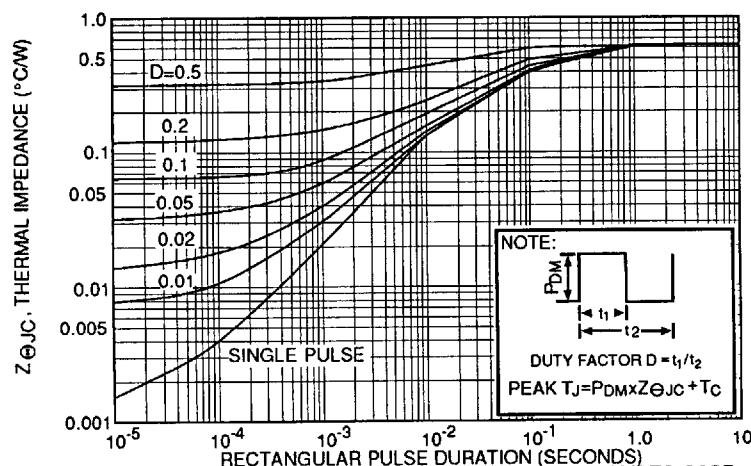
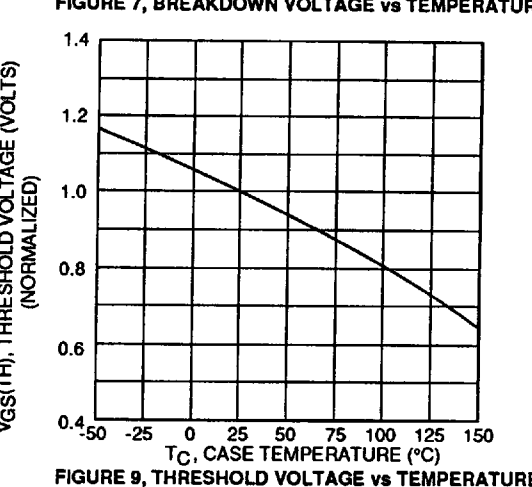
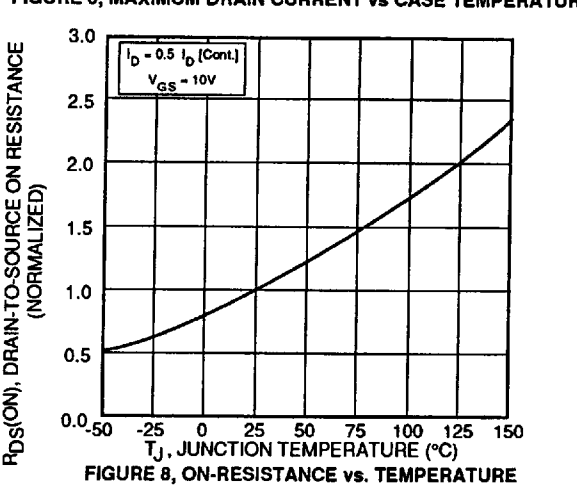
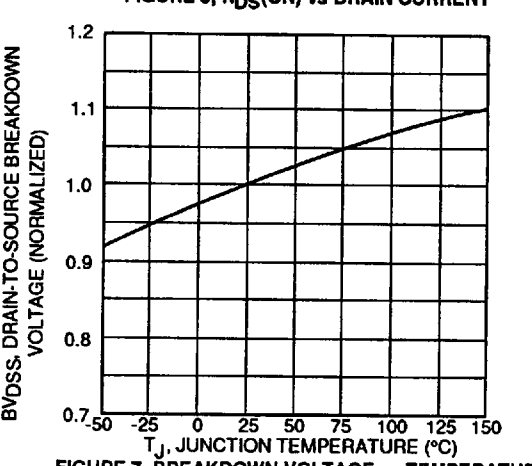
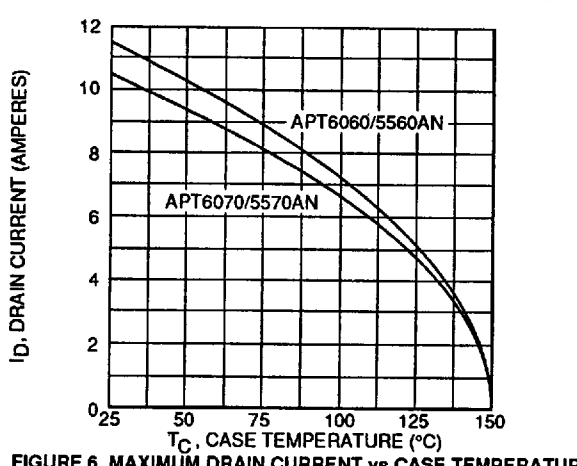
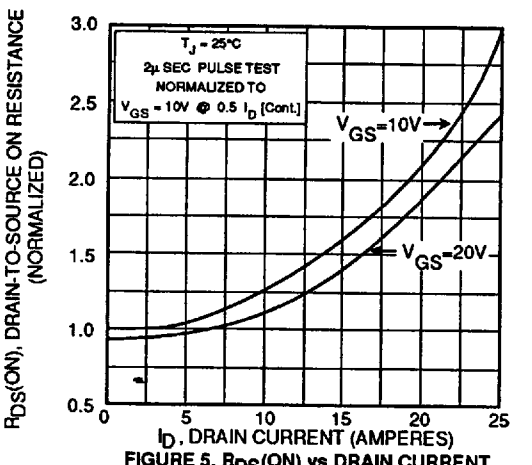
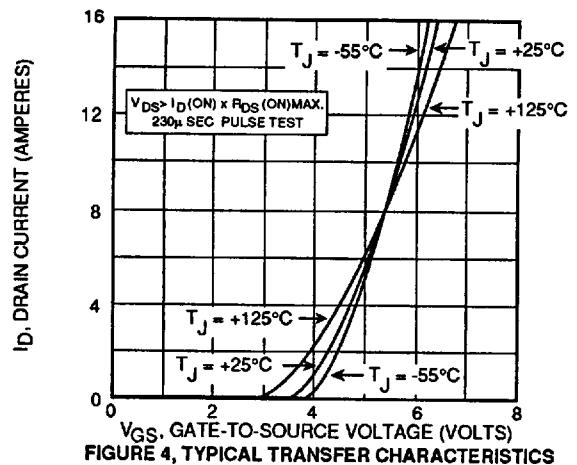
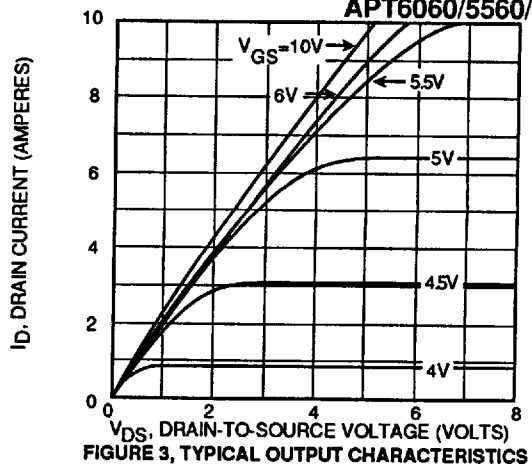
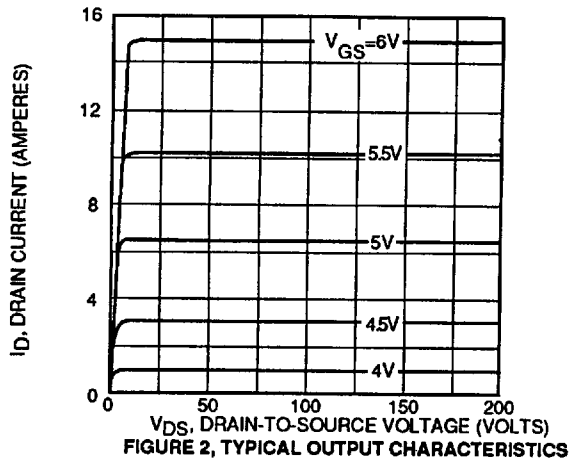

FIGURE 1, MAXIMUM EFFECTIVE TRANSIENT THERMAL IMPEDANCE, JUNCTION-TO-CASE vs PULSE DURATION



T-39-15

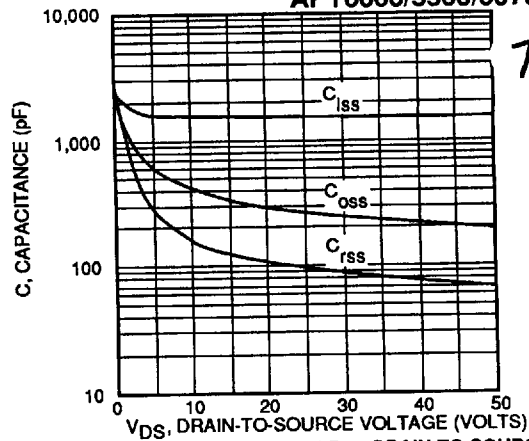
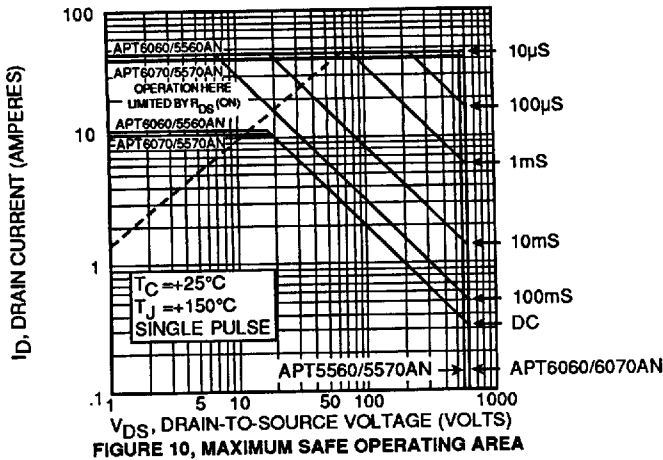

FIGURE 11, TYPICAL CAPACITANCE vs DRAIN-TO-SOURCE VOLTAGE

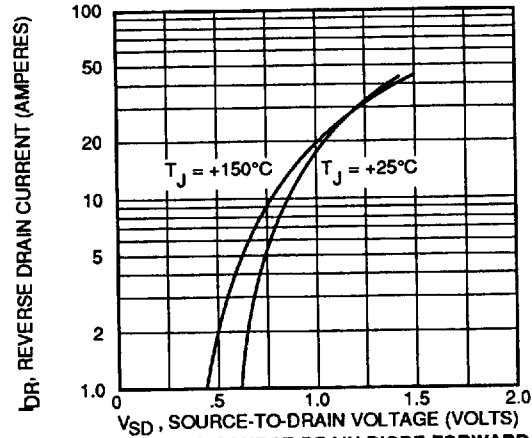
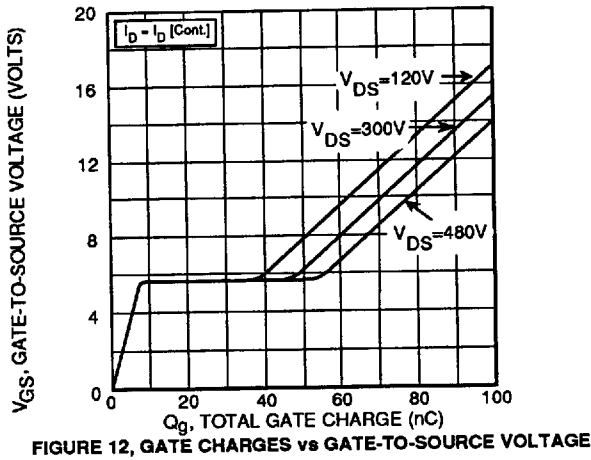
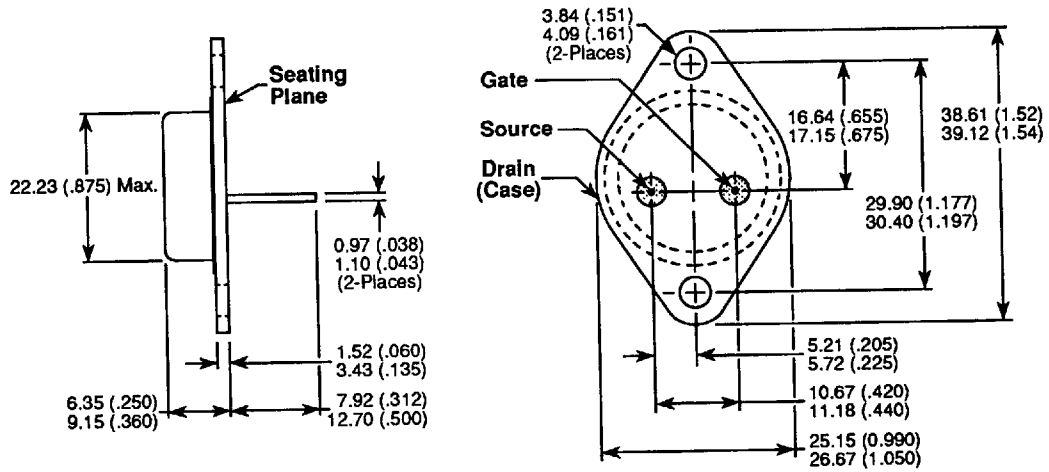

FIGURE 13, TYPICAL SOURCE-DRAIN DIODE FORWARD VOLTAGE

TO-3 Package Outline (TO-204AA)



Dimensions in Millimeters and (Inches)