

74VCXH16374 Low Voltage 16-Bit D-Type Flip-Flops with Bushold

General Description

The VCXH16374 contains sixteen non-inverting D-type flip-flops with 3-STATE outputs and is intended for bus oriented applications. The device is byte controlled. A buffered clock (CP) and output enable (OE) are common to each byte and can be shorted together for full 16-bit operation.

The VCXH16374 data inputs include active bushold circuitry, eliminating the need for external pull-up resistors to hold unused or floating data inputs at a valid logic level.

The 74VCXH16374 is designed for low voltage (1.65V to 3.6V) V_{CC} applications with output compatibility up to 3.6V.

The 74VCXH16374 is fabricated with an advanced CMOS technology to achieve high speed operation while maintaining low CMOS power dissipation.

Features

- 1.65V–3.6V V_{CC} supply operation
- 3.6V tolerant control inputs and outputs
- Bushold on data inputs eliminates the need for external pull-up/pull-down resistors
- t_{PD}
 - 3.0 ns max for 3.0V to 3.6V V_{CC}
 - 3.9 ns max for 2.3V to 2.7V V_{CC}
 - 7.8 ns max for 1.65V to 1.95V V_{CC}
- Static Drive (I_{OH}/I_{OL})
 - ±24 mA @ 3.0V V_{CC}
 - ±18 mA @ 2.3V V_{CC}
 - ±6 mA @ 1.65V V_{CC}
- Uses patented noise/EMI reduction circuitry
- Latch-up performance exceeds 300 mA
- ESD performance:
 - Human body model > 2000V
 - Machine model > 200V
- Also packaged in plastic Fine-Pitch Ball Grid Array (FBGA) (Preliminary)

Ordering Code:

Order Number	Package Number	Package Descriptions
74VCXH16374GX (Note 1)	BGA54A (Preliminary)	54-Ball Fine-Pitch Ball Grid Array (FBGA), JEDEC MO-205, 5.5mm Wide [TAPE and REEL]
74VCXH16374MTD (Note 2)	MTD48	48-Lead Thin Shrink Small Outline Package (TSSOP), JEDEC MO-153, 6.1mm Wide

Note 1: BGA package available in Tape and Reel only.

Note 2: Devices also available in Tape and Reel. Specify by appending suffix letter "X" to the ordering code.

Logic Symbol

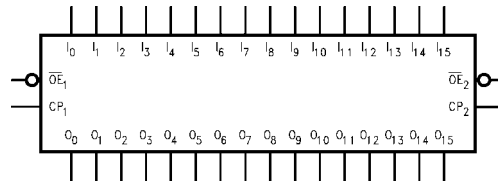

Connection Diagrams

Pin Assignment for TSSOP

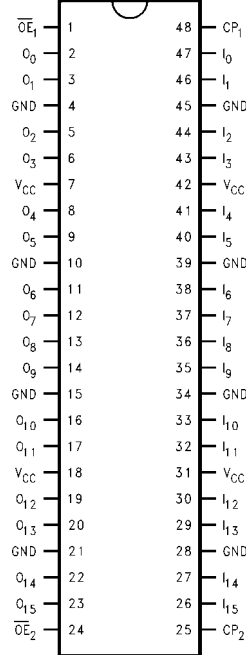

Pin Assignment for FBGA

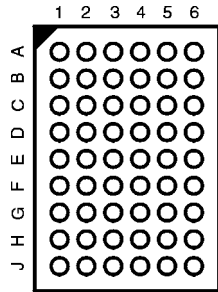

(Top Thru View)

Pin Descriptions

Pin Names	Description
\overline{OE}_n	Output Enable Input (Active LOW)
CP _n	Clock Pulse Input
I ₀ -I ₁₅	Bushold Inputs
O ₀ -O ₁₅	Outputs
NC	No Connect

FBGA Pin Assignments

	1	2	3	4	5	6
A	O ₀	NC	\overline{OE}_1	CP ₁	NC	I ₀
B	O ₂	O ₁	NC	NC	I ₁	I ₂
C	O ₄	O ₃	V _{CC}	V _{CC}	I ₃	I ₄
D	O ₆	O ₅	GND	GND	I ₅	I ₆
E	O ₈	O ₇	GND	GND	I ₇	I ₈
F	O ₁₀	O ₉	GND	GND	I ₉	I ₁₀
G	O ₁₂	O ₁₁	V _{CC}	V _{CC}	I ₁₁	I ₁₂
H	O ₁₄	O ₁₃	NC	NC	I ₁₃	I ₁₄
J	O ₁₅	NC	\overline{OE}_2	CP ₂	NC	I ₁₅

Truth Tables

Inputs			Outputs
CP ₁	\overline{OE}_1	I ₀ -I ₇	O ₀ -O ₇
↗	L	H	H
↗	L	L	L
L	L	X	O ₀
X	H	X	Z

Inputs			Outputs
CP ₂	\overline{OE}_2	I ₈ -I ₁₅	O ₈ -O ₁₅
↗	L	H	H
↗	L	L	L
L	L	X	O ₀
X	H	X	Z

H = HIGH Voltage Level
 L = LOW Voltage Level
 X = Immaterial (HIGH or LOW, control inputs may not float)
 Z = High Impedance
 O₀ = Previous O₀ before HIGH-to-LOW of CP

Functional Description

The 74VCXH16374 consists of sixteen edge-triggered flip-flops with individual D-type inputs and 3-STATE true outputs. The device is byte controlled with each byte functioning identically, but independent of the other. The control pins can be shorted together to obtain full 16-bit operation. Each clock has a buffered clock and buffered Output Enable common to all flip-flops within that byte. The description which follows applies to each byte. Each

flip-flop will store the state of their individual I inputs that meet the setup and hold time requirements on the LOW-to-HIGH Clock (CP_n) transition. With the Output Enable (\overline{OE}_n) LOW, the contents of the flip-flops are available at the outputs. When \overline{OE}_n is HIGH, the outputs go to the high impedance state. Operations of the \overline{OE}_n input does not affect the state of the flip-flops.

Logic Diagram

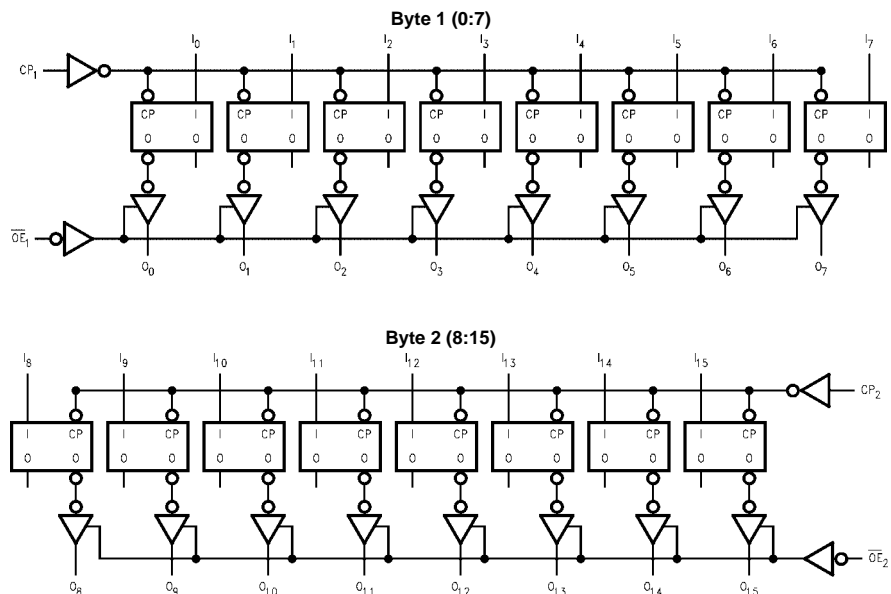

Please note that this diagram is provided only for the understanding of logic operations and should not be used to estimate propagation delays.

Absolute Maximum Ratings(Note 3)

Supply Voltage (V_{CC})	-0.5V to +4.6V
DC Input Voltage (V_I)	
\overline{OE}_n, CP_n	-0.5V to 4.6V
$I_0 - I_{15}$	-0.5V to $V_{CC} + 0.5V$
Output Voltage (V_O)	
Outputs 3-STATED	-0.5V to +4.6V
Outputs Active (Note 4)	-0.5V to $V_{CC} + 0.5V$
DC Input Diode Current (I_{IK})	
$V_I < 0V$	-50 mA
DC Output Diode Current (I_{OK})	
$V_O < 0V$	-50 mA
$V_O > V_{CC}$	+50 mA
DC Output Source/Sink Current (I_{OH}/I_{OL})	± 50 mA
DC V_{CC} or GND Current per Supply Pin (I_{CC} or GND)	± 100 mA
Storage Temperature Range (T_{STG})	-65°C to +150°C

Recommended Operating Conditions (Note 5)

Power Supply	
Operating	1.65V to 3.6V
Data Retention Only	1.2V to 3.6V
Input Voltage	-0.3V to V_{CC}
Output Voltage (V_O)	
Output in Active States	0V to V_{CC}
Output in "OFF" State	0.0V to 3.6V
Output Current in I_{OH}/I_{OL}	
$V_{CC} = 3.0V$ to $3.6V$	± 24 mA
$V_{CC} = 2.3V$ to $2.7V$	± 18 mA
$V_{CC} = 1.65V$ to $2.3V$	± 6 mA
Free Air Operating Temperature (T_A)	-40°C to +85°C
Minimum Input Edge Rate ($\Delta t/\Delta V$)	
$V_{IN} = 0.8V$ to $2.0V$, $V_{CC} = 3.0V$	10 ns/V

Note 3: The Absolute Maximum Ratings are those values beyond which the safety of the device cannot be guaranteed. The device should not be operated at these limits. The parametric values defined in the Electrical Characteristics tables are not guaranteed at the Absolute Maximum Ratings. The "Recommended Operating Conditions" table will define the conditions for actual device operation.

Note 4: I_O Absolute Maximum Rating must be observed.

Note 5: Floating or unused control inputs must be held HIGH or LOW.

DC Electrical Characteristics (2.7V < V_{CC} ≤ 3.6V)

Symbol	Parameter		Conditions	V_{CC} (V)	Min	Max	Units
V_{IH}	HIGH Level Input Voltage			2.7 – 3.6	2.0		V
V_{IL}	LOW Level Input Voltage			2.7 – 3.6		0.8	V
V_{OH}	HIGH Level Output Voltage		$I_{OH} = -100 \mu A$	2.7 – 3.6	$V_{CC} - 0.2$		V
			$I_{OH} = -12$ mA	2.7	2.2		V
			$I_{OH} = -18$ mA	3.0	2.4		V
			$I_{OH} = -24$ mA	3.0	2.2		V
V_{OL}	LOW Level Output Voltage		$I_{OL} = 100 \mu A$	2.7 – 3.6		0.2	V
			$I_{OL} = 12$ mA	2.7		0.4	V
			$I_{OL} = 18$ mA	3.0		0.4	V
			$I_{OL} = 24$ mA	3.0		0.55	V
I_I	Input Leakage Current	Control Pins	$0 \leq V_I \leq 3.6V$	2.7 – 3.6		± 5.0	μA
		Data Pins	$V_I = V_{CC}$ or GND	2.7 – 3.6		± 5.0	μA
$I_{I(HOLD)}$	Bushold Input Minimum		$V_{IN} = 0.8V$	3.0	75		μA
	Drive Hold Current		$V_{IN} = 2.0V$	3.0	-75		
$I_{I(OD)}$	Bushold Input Over-Drive Current to Change State		(Note 6)	3.6	450		μA
			(Note 7)	3.6	-450		
I_{OZ}	3-STATE Output Leakage		$0 \leq V_O \leq 3.6V$ $V_I = V_{IH}$ or V_{IL}	2.7 – 3.6		± 10	μA
I_{OFF}	Power-OFF Leakage Current		$0 \leq (V_O) \leq 3.6V$	0		10	μA
I_{CC}	Quiescent Supply Current		$V_I = V_{CC}$ or GND	2.7 – 3.6		20	μA
			$V_{CC} \leq (V_O) \leq 3.6V$ (Note 8)	2.7 – 3.6		± 20	
ΔI_{CC}	Increase in I_{CC} per Input		$V_{IH} = V_{CC} - 0.6V$	2.7 – 3.6		750	μA

Note 6: An external driver must source at least the specified current to switch from LOW-to-HIGH.

Note 7: An external driver must sink at least the specified current to switch from HIGH-to-LOW.

Note 8: Outputs disabled or 3-STATE only.

DC Electrical Characteristics (2.3V ≤ V _{CC} ≤ 2.7V)						
Symbol	Parameter	Conditions	V _{CC} (V)	Min	Max	Units
V _{IH}	HIGH Level Input Voltage		2.3 - 2.7	1.6		V
V _{IL}	LOW Level Input Voltage		2.3 - 2.7		0.7	V
V _{OH}	HIGH Level Output Voltage	I _{OH} = -100 μA	2.3 - 2.7	V _{CC} - 0.2		V
		I _{OH} = -6 mA	2.3	2.0		V
		I _{OH} = -12 mA	2.3	1.8		V
		I _{OH} = -18 mA	2.3	1.7		V
V _{OL}	LOW Level Output Voltage	I _{OL} = 100 μA	2.3 - 2.7		0.2	V
		I _{OL} = 12 mA	2.3		0.4	V
		I _{OL} = 18 mA	2.3		0.6	V
I _I	Input Leakage Current	Control Pins 0 ≤ V _I ≤ 3.6V	2.3 - 2.7		±5.0	μA
		Data Pins V _I = V _{CC} or GND	2.3 - 2.7		±5.0	μA
I _{I(HOLD)}	Bushold Input Minimum Drive Hold Current	V _{IN} = 0.7V	2.3	45		μA
		V _{IN} = 1.6V	2.3	-45		
I _{I(OD)}	Bushold Input Over-Drive Current to Change State	(Note 9)	2.7	300		μA
		(Note 10)	2.7	-300		
I _{OZ}	3-STATE Output Leakage	0 ≤ V _O ≤ 3.6V V _I = V _{IH} or V _{IL}	2.3 - 2.7		±10	μA
I _{OFF}	Power-OFF Leakage Current	0 ≤ (V _O) ≤ 3.6V	0		10	μA
I _{CC}	Quiescent Supply Current	V _I = V _{CC} or GND	2.3 - 2.7		20	μA
		V _{CC} ≤ (V _O) ≤ 3.6V (Note 11)	2.3 - 2.7		±20	μA
<p>Note 9: An external driver must source at least the specified current to switch from LOW-to-HIGH.</p> <p>Note 10: An external driver must sink at least the specified current to switch from HIGH-to-LOW.</p> <p>Note 11: Outputs disabled or 3-STATE only.</p>						
DC Electrical Characteristics (1.65V ≤ V _{CC} < 2.3V)						
Symbol	Parameter	Conditions	V _{CC} (V)	Min	Max	Units
V _{IH}	HIGH Level Input Voltage		1.65 - 2.3	0.65 × V _{CC}		V
V _{IL}	LOW Level Input Voltage		1.65 - 2.3		0.35 × V _{CC}	V
V _{OH}	HIGH Level Output Voltage	I _{OH} = -100 μA	1.65 - 2.3	V _{CC} - 0.2		V
		I _{OH} = -6 mA	1.65	1.25		V
V _{OL}	LOW Level Output Voltage	I _{OL} = 100 μA	1.65 - 2.3		0.2	V
		I _{OL} = 6 mA	1.65		0.3	V
I _I	Input Leakage Current	Control Pins 0 ≤ V _I ≤ 3.6V	1.65 - 2.3		±5.0	μA
		Data Pins V _I = V _{CC} or GND	1.65 - 2.3		±5.0	μA
I _{I(HOLD)}	Bushold Input Minimum Drive Hold Current	V _{IN} = 0.57V	1.65	25		μA
		V _{IN} = 1.07V	1.65	-25		
I _{I(OD)}	Bushold Input Over-Drive Current to Change State	(Note 12)	1.95	200		μA
		(Note 13)	1.95	-200		
I _{OZ}	3-STATE Output Leakage	0 ≤ V _O ≤ 3.6V V _I = V _{IH} or V _{IL}	1.65 - 2.3		±10	μA
I _{OFF}	Power-OFF Leakage Current	0 ≤ (V _O) ≤ 3.6V	0		10	μA
I _{CC}	Quiescent Supply Current	V _I = V _{CC} or GND	1.65 - 2.3		20	μA
		V _{CC} ≤ (V _O) ≤ 3.6V (Note 14)	1.65 - 2.3		±20	μA
<p>Note 12: An external driver must source at least the specified current to switch from LOW-to-HIGH.</p> <p>Note 13: An external driver must sink at least the specified current to switch from HIGH-to-LOW.</p> <p>Note 14: Outputs disabled or 3-STATE only.</p>						

AC Electrical Characteristics (Note 15)								
Symbol	Parameter	$T_A = -40^\circ\text{C to } +85^\circ\text{C}, C_L = 30\text{ pF}, R_L = 500\Omega$						Units
		$V_{CC} = 3.3V \pm 0.3V$		$V_{CC} = 2.5V \pm 0.2V$		$V_{CC} = 1.8V \pm 0.15V$		
		Min	Max	Min	Max	Min	Max	
f_{MAX}	Maximum Clock Frequency	250		200		100		MHz
t_{PHL}, t_{PLH}	Propagation Delay CP to O_n	0.8	3.0	1.0	3.9	1.5	7.8	ns
t_{PZL}, t_{PZH}	Output Enable Time	0.8	3.5	1.0	4.6	1.5	9.2	ns
t_{PLZ}, t_{PHZ}	Output Disable Time	0.8	3.5	1.0	3.8	1.5	6.8	ns
t_S	Setup Time	1.5		1.5		2.5		ns
t_H	Hold Time	1.0		1.0		1.0		ns
t_W	Pulse Width	1.5		1.5		4.0		ns
t_{OSHL}, t_{OSLH}	Output to Output Skew (Note 16)		0.5		0.5		0.75	ns
<p>Note 15: For $C_L = 50\text{ pF}$, add approximately 300 ps to the AC maximum specification.</p> <p>Note 16: Skew is defined as the absolute value of the difference between the actual propagation delay for any two separate outputs of the same device. The specification applies to any outputs switching in the same direction, either HIGH-to-LOW (t_{OSHL}) or LOW-to-HIGH (t_{OSLH}).</p>								
Dynamic Switching Characteristics								
Symbol	Parameter	Conditions	V_{CC} (V)	$T_A = +25^\circ\text{C}$	Units			
				Typical				
V_{OLP}	Quiet Output Dynamic Peak V_{OL}	$C_L = 30\text{ pF}, V_{IH} = V_{CC}, V_{IL} = 0V$	1.8 2.5 3.3	0.25 0.6 0.8	V			
V_{OLV}	Quiet Output Dynamic Valley V_{OL}	$C_L = 30\text{ pF}, V_{IH} = V_{CC}, V_{IL} = 0V$	1.8 2.5 3.3	-0.25 -0.6 -0.8	V			
V_{OHV}	Quiet Output Dynamic Valley V_{OH}	$C_L = 30\text{ pF}, V_{IH} = V_{CC}, V_{IL} = 0V$	1.8 2.5 3.3	1.5 1.9 2.2	V			
Capacitance								
Symbol	Parameter	Conditions	$T_A = +25^\circ\text{C}$	Units				
			Typical					
C_{IN}	Input Capacitance	$V_{CC} = 1.8V, 2.5V$ or $3.3V, V_I = 0V$ or V_{CC}	6	pF				
C_{OUT}	Output Capacitance	$V_I = 0V$ or $V_{CC}, V_{CC} = 1.8V, 2.5V$ or $3.3V$	7	pF				
C_{PD}	Power Dissipation Capacitance	$V_I = 0V$ or $V_{CC}, f = 10\text{ MHz}, V_{CC} = 1.8V, 2.5V$ or $3.3V$	20	pF				

AC Loading and Waveforms

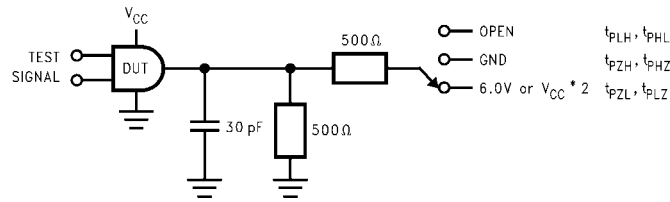

TEST	SWITCH
t_{PLH}, t_{PHL}	Open
t_{PZL}, t_{PLZ}	6V at $V_{CC} = 3.3 \pm 0.3V$; $V_{CC} \times 2$ at $V_{CC} = 2.5 \pm 0.2V; 1.8V \pm 0.15V$
t_{PZH}, t_{PHZ}	GND

FIGURE 1. AC Test Circuit

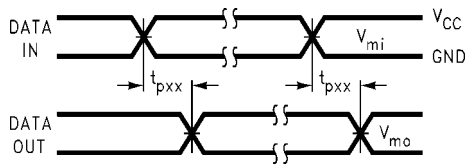

FIGURE 2. Waveform for Inverting and Non-Inverting Functions

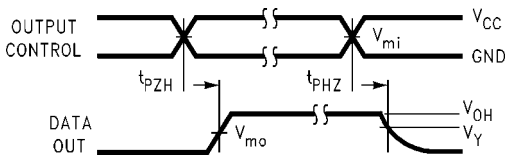

FIGURE 3. 3-STATE Output High Enable and Disable Times for Low Voltage Logic

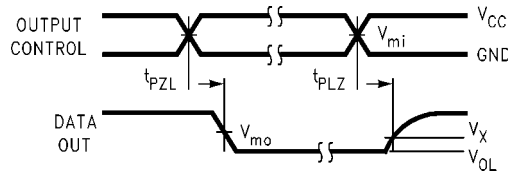

FIGURE 4. 3-STATE Output Low Enable and Disable Times for Low Voltage Logic

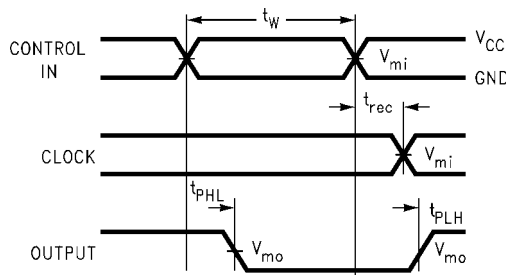

FIGURE 5. Propagation Delay, Pulse Width and t_{REC} Waveforms

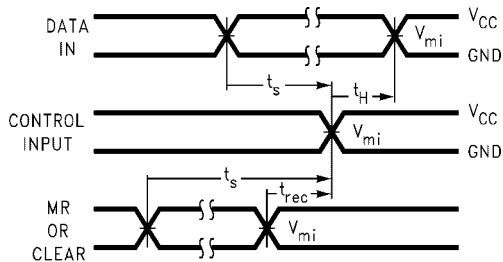
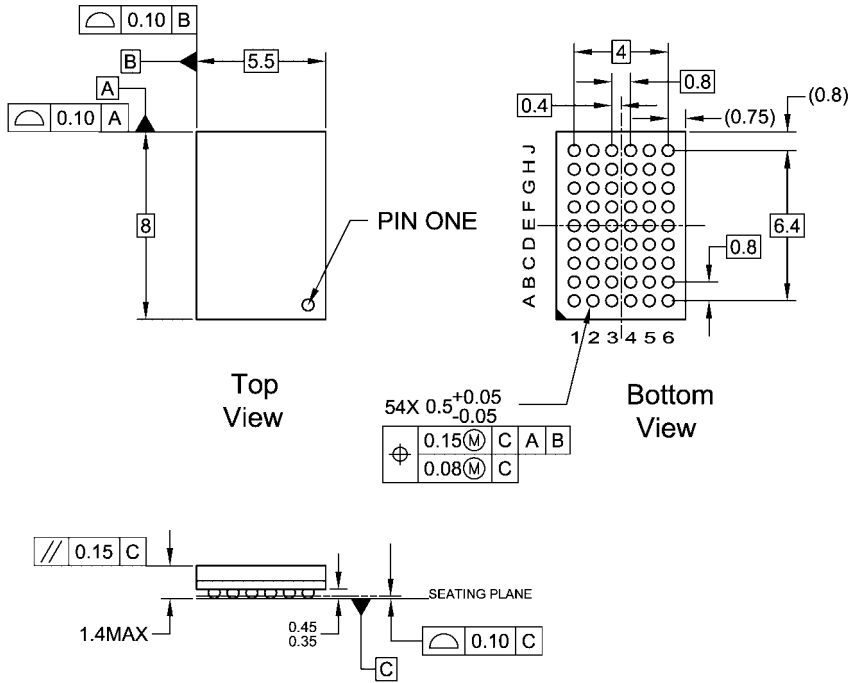

FIGURE 6. Setup Time, Hold Time and Recovery Time for Low Voltage Logic

Symbol	V_{CC}		
	$3.3V \pm 0.3V$	$2.5V \pm 0.2V$	$1.8V \pm 0.15V$
V_{mi}	1.5V	$V_{CC}/2$	$V_{CC}/2$
V_{mo}	1.5V	$V_{CC}/2$	$V_{CC}/2$
V_X	$V_{OL} + 0.3V$	$V_{OL} + 0.15V$	$V_{OL} + 0.15V$
V_Y	$V_{OH} - 0.3V$	$V_{OH} - 0.15V$	$V_{OH} - 0.15V$

Physical Dimensions inches (millimeters) unless otherwise noted



NOTES:

- A. THIS PACKAGE CONFORMS TO JEDEC M0-205
- B. ALL DIMENSIONS IN MILLIMETERS
- C. LAND PATTERN RECOMMENDATION: NSMD (Non Solder Mask Defined)
.35MM DIA PADS WITH A SOLDERMASK OPENING OF .45MM CONCENTRIC TO PADS
- D. DRAWING CONFORMS TO ASME Y14.5M-1994

BGA54ArevD

**54-Ball Fine-Pitch Ball Grid Array (FBGA), JEDEC MO-205, 5.5mm Wide
Package Number BGA54A
(Preliminary)**

Physical Dimensions inches (millimeters) unless otherwise noted (Continued)

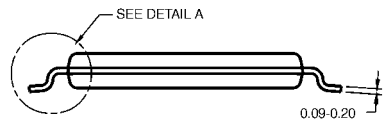
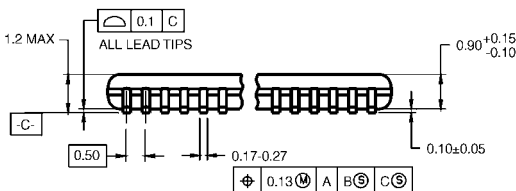
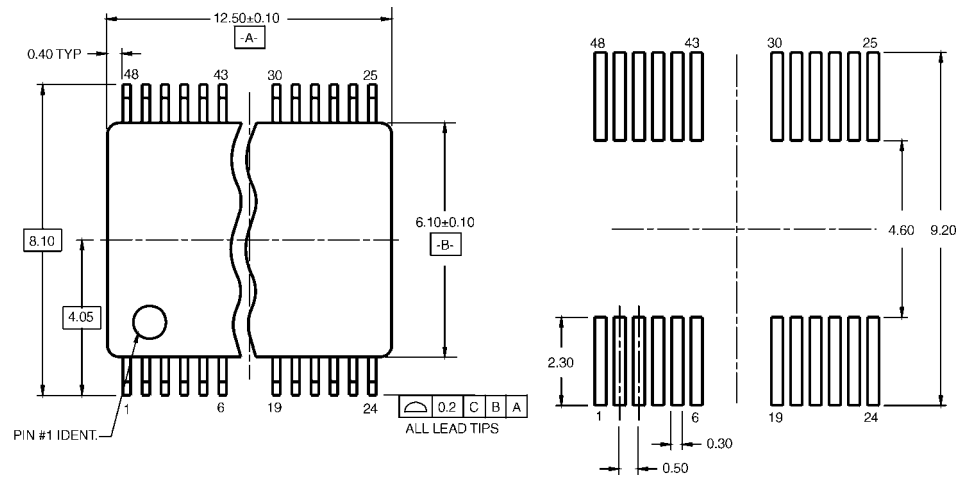

DIMENSIONS ARE IN MILLIMETERS

- NOTES:
- A. CONFORMS TO JEDEC REGISTRATION MO-153, VARIATION AB, REF NOTE 6, DATE 7/93.
 - B. DIMENSIONS ARE IN MILLIMETERS.
 - C. DIMENSIONS ARE EXCLUSIVE OF BURRS, MOLD FLASH, AND TIE BAR EXTRUSIONS.
 - D. DIMENSIONS AND TOLERANCES PER ANSI Y14.5M, 1982.

MTD48RevB1

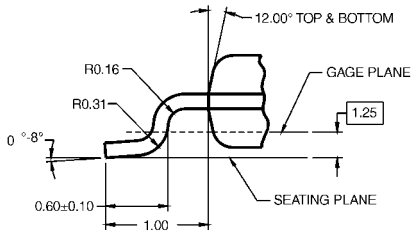

48-Lead Thin Shrink Small Outline Package (TSSOP), JEDEC MO-153, 6.1mm Wide Package Number MTD48

Fairchild does not assume any responsibility for use of any circuitry described, no circuit patent licenses are implied and Fairchild reserves the right at any time without notice to change said circuitry and specifications.

LIFE SUPPORT POLICY

FAIRCHILD'S PRODUCTS ARE NOT AUTHORIZED FOR USE AS CRITICAL COMPONENTS IN LIFE SUPPORT DEVICES OR SYSTEMS WITHOUT THE EXPRESS WRITTEN APPROVAL OF THE PRESIDENT OF FAIRCHILD SEMICONDUCTOR CORPORATION. As used herein:

1. Life support devices or systems are devices or systems which, (a) are intended for surgical implant into the body, or (b) support or sustain life, and (c) whose failure to perform when properly used in accordance with instructions for use provided in the labeling, can be reasonably expected to result in a significant injury to the user.
2. A critical component in any component of a life support device or system whose failure to perform can be reasonably expected to cause the failure of the life support device or system, or to affect its safety or effectiveness.

www.fairchildsemi.com