

SANYO

LC78835K, 78835KM

18 Bits Digital Filter and D/A Converter for Digital Audio

Overview

The LC78835K and 78835KM are 18-bit digital-to-analog D/A converter CMOS ICs with an on-chip eight-times oversampling digital filter. The LC78835 and the LC78835M are pin compatible.

Features

- Digital filter
 - 8 fs oversampling filter: 3-stage finite-impulse-response (FIR) filter design (43rd-, 11th-, and third-orders)
 - De-emphasis filter: Supports fs = 32 kHz, 44.1 kHz, or 48 kHz
 - Soft mute
 - Noise shaper
 - Supports double-rate sampling
- D/A converter
 - Dynamic level-shifting 18-bit digital-to-analog converter
 - On-chip 2-channel D/A converter (with corresponding output)
 - On-chip output op-amp
 - Supports 384 fs, 392 fs, 448 fs, or 512 fs system clock
 - Single 5 V supply
 - Permits low-voltage operation (3.5 V)
 - Low-power silicon-gate CMOS process

Package Dimensions

unit: mm

3092-DIP24W

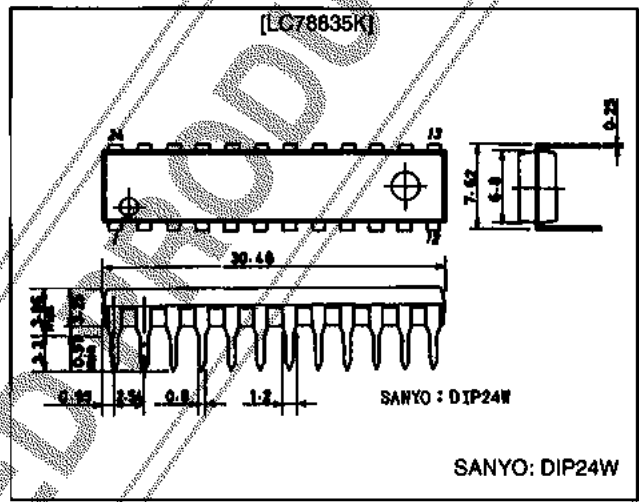

unit: mm

3155-MFP24

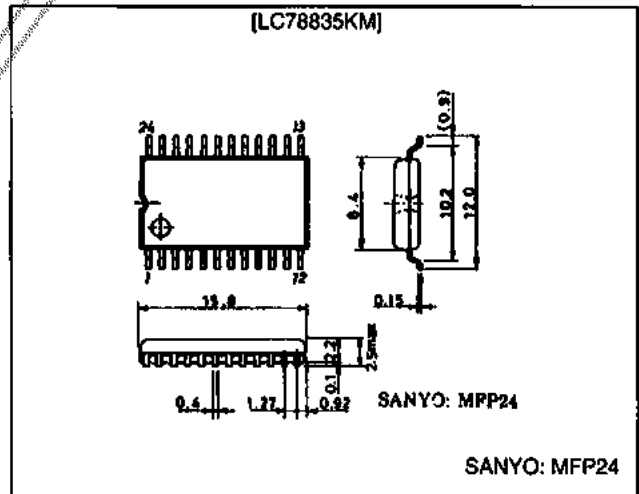

Specifications

Absolute Maximum Ratings at $T_a = 25^\circ\text{C}$, $V_{SS} = 0^\circ\text{C}$

Parameter	Symbol	Conditions	Ratings	Unit
Maximum supply voltage	$V_{DD\ max}$		-0.3 to +7.0	V
Input voltage	V_{IN}		-0.3 to $V_{DD} + 0.3$	V
Output voltage	V_{OUT}		-0.3 to $V_{DD} + 0.3$	V
Operating temperature	T_{opr}		-30 to +75	$^\circ\text{C}$
Storage temperature	T_{stg}		-40 to +125	$^\circ\text{C}$

Allowable Operating Ranges

Parameter	Symbol	Conditions	Ratings			Unit
			min	typ	max	
Supply voltage	V_{DD}		3.5	5.0	5.5	V
Reference voltage high	$V_{ref\ H}$		$V_{DD} - 0.3$		V_{DD}	V
Reference voltage low	$V_{ref\ L}$		0		0.3	V
Operating temperature	T_{opr}		-30		+75	$^\circ\text{C}$

DC Characteristics at $T_a = -30$ to $+75^\circ\text{C}$, $V_{DD} = 3.5$ to 5.5 V , $V_{SS} = 0\text{ V}$

Parameter	Symbol	Conditions	Ratings			Unit
			min	typ	max	
Input high level voltage (1)	V_{IH1}	3, 4, 5, 6, 7, 13, 14, 15, 16, 17 and 18 pin	2.2			V
Input low level voltage (1)	V_{IL1}	3, 4, 5, 6, 7, 13, 14, 15, 16, 17 and 18 pin			0.8	V
Input high level voltage (2)	V_{IH2}	11 pin	$0.7V_{DD}$			V
Input low level voltage (2)	V_{IL2}	11 pin			$0.3V_{DD}$	V
Output high level voltage	V_{OH}	9 pin: $I_{OH} = -3\text{ mA}$	2.4			V
Output low level voltage	V_{OL}	9 pin: $I_{OL} = 3\text{ mA}$			0.4	V
Input leakage current	I_L	* $V_I = V_{SS}, V_{DD}$	-25		+25	μA

Note: * 3, 4, 5, 6, 7, 11, 13, 14, 15, 16, 17 and 18 pin

AC Characteristics at $T_a = -30$ to $+75^\circ\text{C}$, $V_{DD} = 3.5$ to 5.5 V , $V_{SS} = 0\text{ V}$

Parameter	Symbol	Conditions	Ratings			Unit
			min	typ	max	
Oscillation frequency	f_x	XIN pin for crystal oscillator	1.0		25	MHz
Clock pulse width	t_{CW}	With external clock input to other than XIN pin	18			ns
Clock pulse phase	t_{CP}	With external clock input to other than XIN pin	40		1000	ns
BCLK pulse width	t_{BCW}		60			ns
BCLK pulse phase	t_{BCP}		120			ns
Data setup time	t_{DS}		40			ns
Data hold time	t_{DH}		40			ns
LACK setup time	t_{LRS}		40			ns
LACK hold time	t_{LRH}		40			ns

Audio Input Waveforms

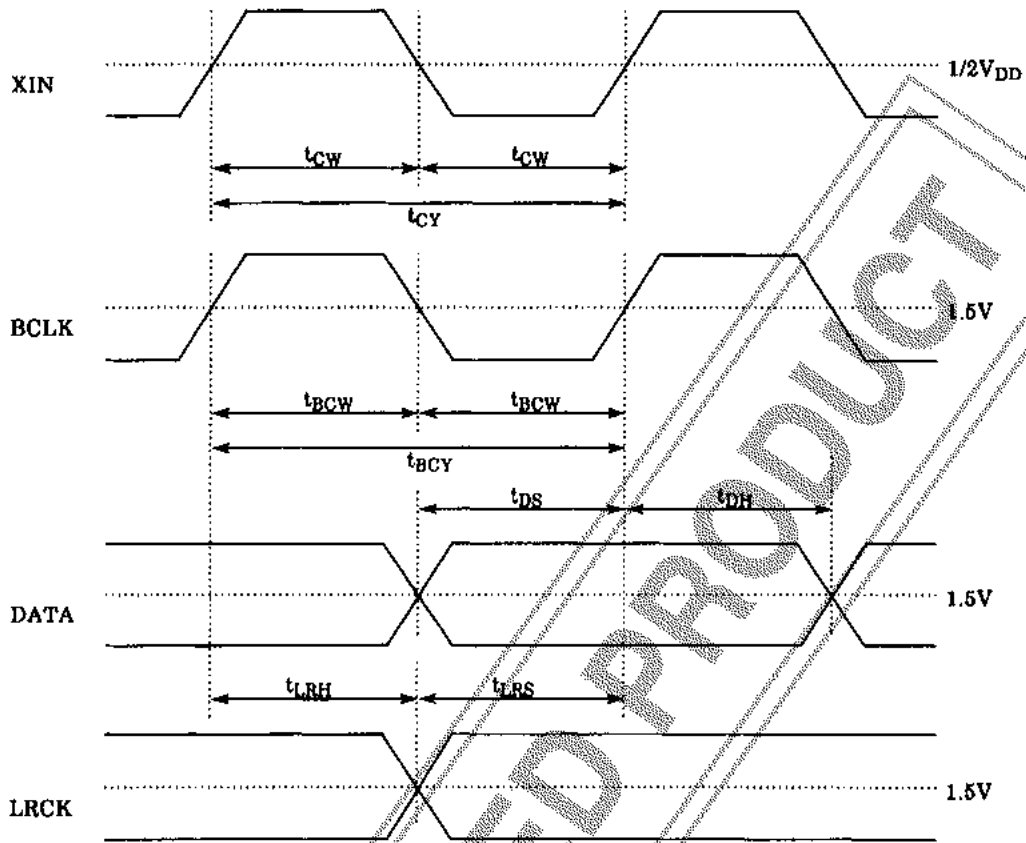

Electrical Characteristics (1)

at Ta = 25°C, AV_{DD} = DV_{DD} = V_{refH} = 5.0 V, AGND = DGND = V_{refL} = 0 V, unless otherwise specified

Parameter	Symbol	Conditions	Ratings			Unit
			min	typ	max	
D/A converter resolution	RES			18		Bits
Total harmonic distortion	THD	At 1 kHz, 0 dB*1			0.08	%
Dynamic range	DR	At 1 kHz, -60 dB	90			dB
Crosstalk	CT	At 1 kHz, 0 dB			-85	dB
Signal-to-noise ratio	S/N	IIS-A	96			dB
Full-scale output voltage	VFS			3.0		V _{p,p}
Power dissipation	Pd	*2		135	200	mW
Output load resistance	RL	21, 23 pin	5			kΩ

Note: 1. "0 dB" signal is full scale.
 2. XIN pulse width (pin 11) 1.5 to 3.5 V, fx = 36.9344 MHz
 Test circuit: Based on application circuit

LC78835K, 78835KM

Electrical Characteristics (2)

at $T_a = 25^\circ\text{C}$, $AV_{DD} = DV_{DD} = V_{refH} 3.5\text{ V}$, $AGND = DGND = V_{refH} = 0\text{ V}$, unless otherwise specified

Parameter	Symbol	Conditions	Ratings			Unit
			min	typ	max	
D/A converter resolution	RES			18		Bits
Total harmonic distortion	THD	At 1 kHz, 0dB ⁻¹			0.09	%
Dynamic range	DR	At 1 kHz, -60 dB	90			dB
Crosstalk	CT	At 1 kHz, 0 dB			-85	dB
Signal-to-noise ratio	S/N	JIS-A	96			dB
Full-scale output voltage	VFS			2.1		V _{p.p}
Power dissipation	P _d	*2		50	75	mW
Output load resistance	RL	21, 23 pin	15			kΩ

Note: 1. "0 dB" signifies full scale.

2. XIN pulse width (pin 11) 1.0 to 2.5 V, $f_x = 16.9344\text{ MHz}$

Test circuit: Based on application circuit

Block Diagram

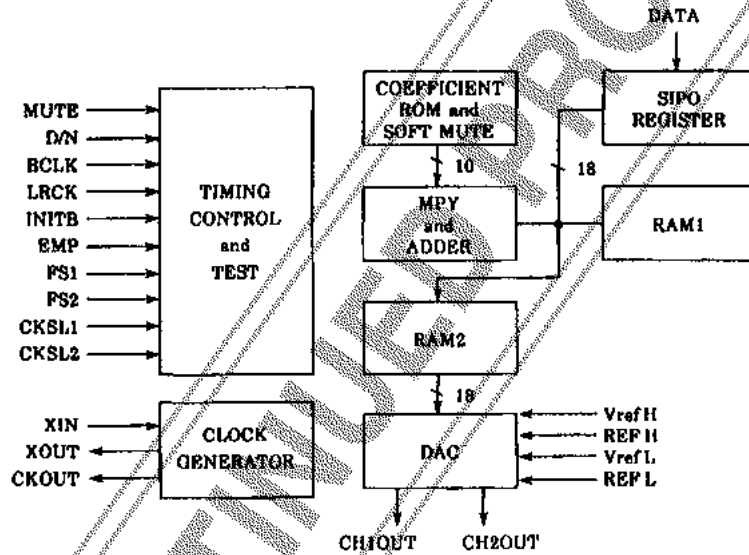

Pin Assignment

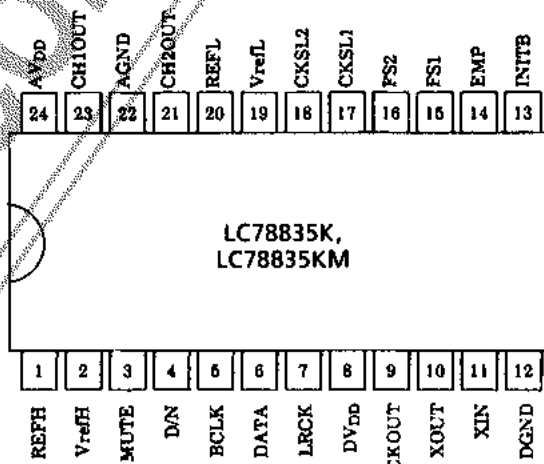

Top view

Pin Description

Number	Name	Description															
1	REFH	Reference voltage "H" pin Normally connected to AGND via a capacitor															
2	VrefH	Reference voltage "H" input pin															
3	MUTE	Mute signal input pin Soft mute is on when high															
4	D/N	Normal/double-speed operation toggle Double-speed operation when high, normal operation when low															
5	BCLK	Bit clock input pin															
6	DATA	Digital audio data input pin 2's complement code, with input from the most significant bit (MSB)															
7	LRCK	Left-right clock input pin Channel 1 when high, channel 2 when low															
8	DVDD	Digital power supply pin															
9	CKOUT	Clock output pin When at 392 fs: 196 fs clock When not at 392 fs: XIN-frequency clock															
10	XOUT	Crystal oscillator output pin (system clock output pin)															
11	XIN	Crystal oscillator input pin (system clock input pin)															
12	DGND	Digital ground pin															
13	INITB	Initialization signal input pin Initialization performed when low															
14	EMP	On/Off toggle for the de-emphasis filter On when high, off when low															
15	FS1	32 kHz/44.1 kHz/48 kHz selector for the de-emphasis filter															
16	FS2	<table border="1"> <tr> <td>FS1</td> <td>L</td> <td>H</td> <td>H</td> <td>L</td> </tr> <tr> <td>FS2</td> <td>L</td> <td>L</td> <td>H</td> <td>H</td> </tr> <tr> <td>fs</td> <td>44.1 kHz</td> <td>32 kHz</td> <td>48 kHz</td> <td></td> </tr> </table>	FS1	L	H	H	L	FS2	L	L	H	H	fs	44.1 kHz	32 kHz	48 kHz	
FS1	L	H	H	L													
FS2	L	L	H	H													
fs	44.1 kHz	32 kHz	48 kHz														
17	CKSL1	System clock selector pin															
18	CKSL2	<table border="1"> <tr> <td>CKSL1</td> <td>CKSL2</td> <td>System Clock</td> </tr> <tr> <td>L</td> <td>L</td> <td>384 fs</td> </tr> <tr> <td>L</td> <td>H</td> <td>392 fs</td> </tr> <tr> <td>H</td> <td>L</td> <td>448 fs</td> </tr> <tr> <td>H</td> <td>H</td> <td>512 fs</td> </tr> </table>	CKSL1	CKSL2	System Clock	L	L	384 fs	L	H	392 fs	H	L	448 fs	H	H	512 fs
CKSL1	CKSL2	System Clock															
L	L	384 fs															
L	H	392 fs															
H	L	448 fs															
H	H	512 fs															
19	VrefL	Reference voltage "L" input pin															
20	REFL	Reference voltage "L" pin Normally connected to AGND via a capacitor															
21	CH2OUT	Channel 2 analog output pin															
22	AGND	Analog ground pin															
23	CH1OUT	Channel 1 analog output pin															
24	AVDD	Analog power supply pin															

Description of Operation

1. Digital Filter

The LC78835K and 78835KM perform arithmetic functions as shown in the following block diagrams.

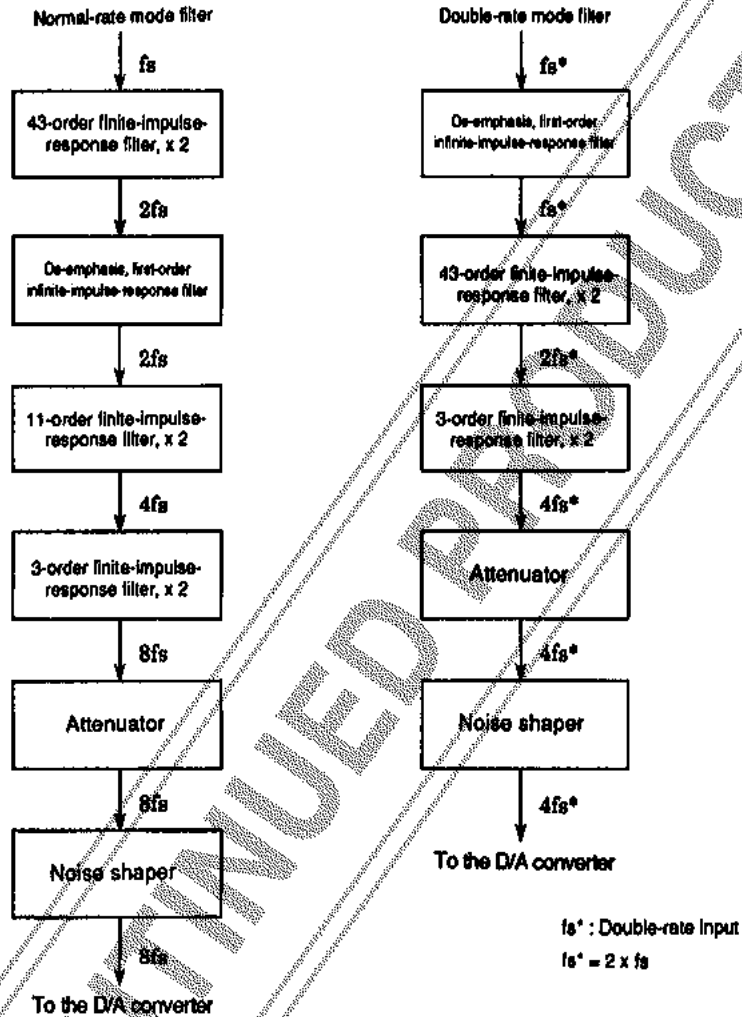

• **Oversampling**

Constructed of twice as many interpolation filters with a cascade connection arrangement using finite-impulse-response (FIR) filters. When operating in normal-rate mode, data is transferred through a three-stage cascading process consisting of 43rd-order, 11th-order, and third-order finite impulse response (FIR) filters connected together to produce an eight-times oversampled signal. When operating in double-rate mode, data is transferred through a two-stage cascading process consisting of 43rd-order and second-order finite-impulse-response (FIR) connected filters to give a four-times oversampled signal. For further details concerning filter characteristics, refer to page 12.

• **De-emphasis**

Digital de-emphasis is performed using a first-order infinite-impulse-response (IIR) filter. Filter supported sampling frequencies include $f_s = 32 \text{ kHz}$, 44.1 kHz and 48 kHz (frequencies are all doubled with double-rate mode).

For further details concerning filter characteristics when de-emphasis is on, refer to page 13.

- De-emphasis on/off
De-emphasis on: EMP pin = “H”
De-emphasis off: EMP pin = “L”
- Selection of filter coefficient

FS1	L	H	H	L
FS2	L	L	H	H
fs	44.1 kHz		32 kHz	48 kHz

• Soft Mute

Soft muting is performed using the built-in digital attenuator. The attenuation amount of the attenuator circuit is as follows:

$$20 \log (ATT/256) \text{ dB}$$

Although $ATT = 0$ to 256 , when $ATT = 0$, attenuation sets to $-\infty$. If the MUTE pin is set to “H” level, ATT approaches 0 in single-decreasing increments and the attenuation changes towards $-\infty$. On the other hand, when the MUTE pin is set to the “L” level, ATT approaches 256 in single-increasing increments and the attenuation amount changes to approach 0 . The approximate speed during soft mute is $1024/fs$.

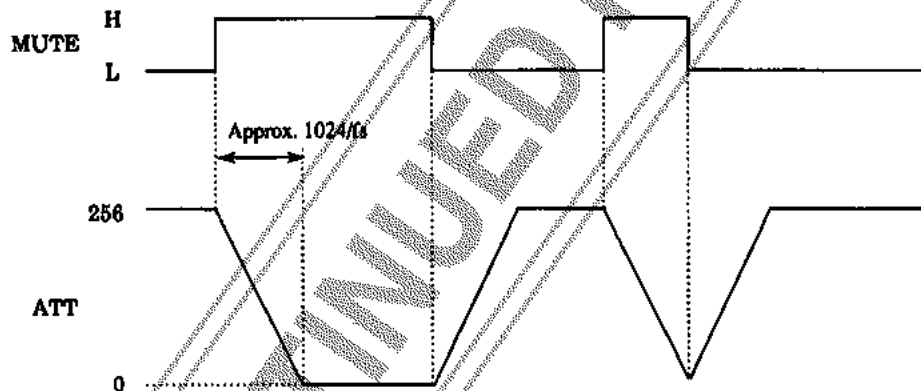

• Noise Shaper

In order to reduce noise during DF arithmetic output requantization, the first-order noise shaper is utilized.

• Double-Rate Support

When the D/N pin is set to “H” level, CD high-speed playback is supported. At this time, BCLK, LRCK and DATA are input at double the frequency of normal operating times. The system clock operates at $384 fs$ and with a clock speed of $512 fs$, double-rate is supported. Note that test mode is enabled for clock speeds of $392 fs$ and $448 fs$ and double-rate is not supported.

Normal-rate mode: D/N pin = “L”
Double-rate mode: D/N pin = “H”

2. Initialization

Initialization is necessary when power is applied or the system clock is replaced. When the INITB pin has been set to an "L" level, the supply to XIN, BCLK, and LRCK should be connected only after the supply has stabilized at the "L" level. As shown in the figure, a period greater than one LRCK cycle is required.

When INITB = "L," all 18-bit digital filter outputs set to 0, and the D/A converter's output (CH1OUT, CH2OUT) equals 0 analog output (approximately (VREFH + VREFL)/2 electric potential).

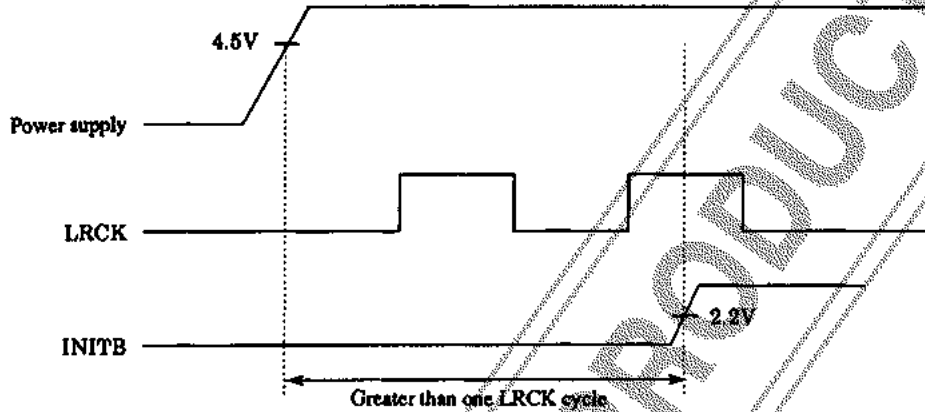

3. System Clock

This IC supports four system clock speeds including 384 fs, 392 fs, 448 fs, and 512 fs. These may be selected using the CKSL1 and CKSL2 pins.

CKSL1	CKSL2	System Clock
L	L	384 fs
L	H	392 fs
H	L	448 fs
H	H	512 fs

• CKOUT Pin

When operating at 392 fs, clock output is 196 fs or half that of the system clock. All other speeds result in clock output equal to that of the system.

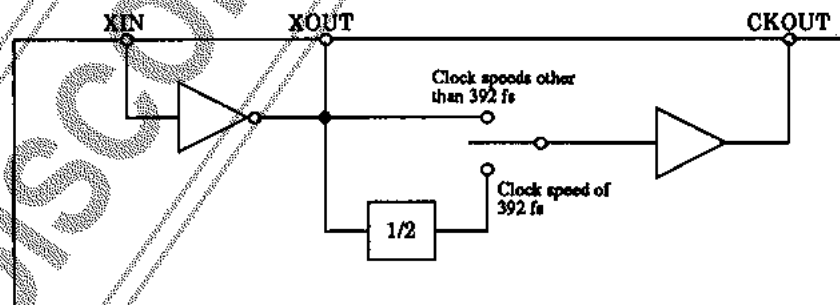

4. Digital Audio Data Input

Digital audio data supports MSB first and 2's complement code using a 16-bit serial signal. 16-bit serial data is input from the DATA pin at the edge of BCLK rising and is input to the internal register along with readings at the rising and falling edges of LRCK.

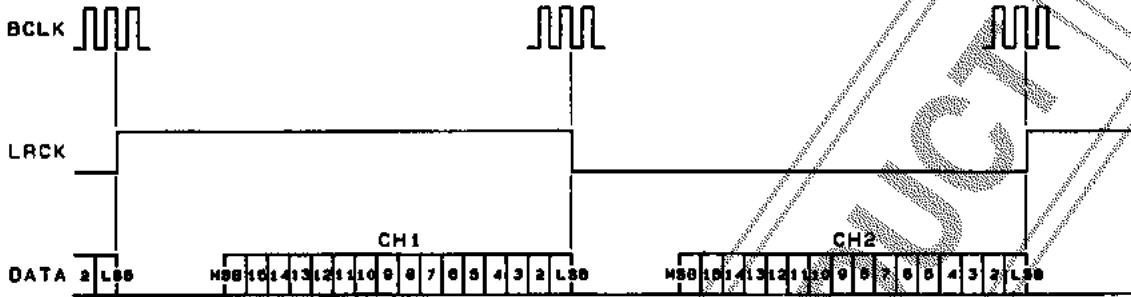

A00737

Digital Audio Data Input Timing

DISCONTINUED PRODUCT

5. Digital-to-Analog (D/A) Converter

These chips have built-in output operational amplifiers which use two independent on-chip D/A converters for CH1 and CH2. Both use dynamic level shift, combining resistance strings (R-string D/A conversion), pulse-width modulation (PWM D/A conversion) and level shift D/A conversion modes. (See figure below.)

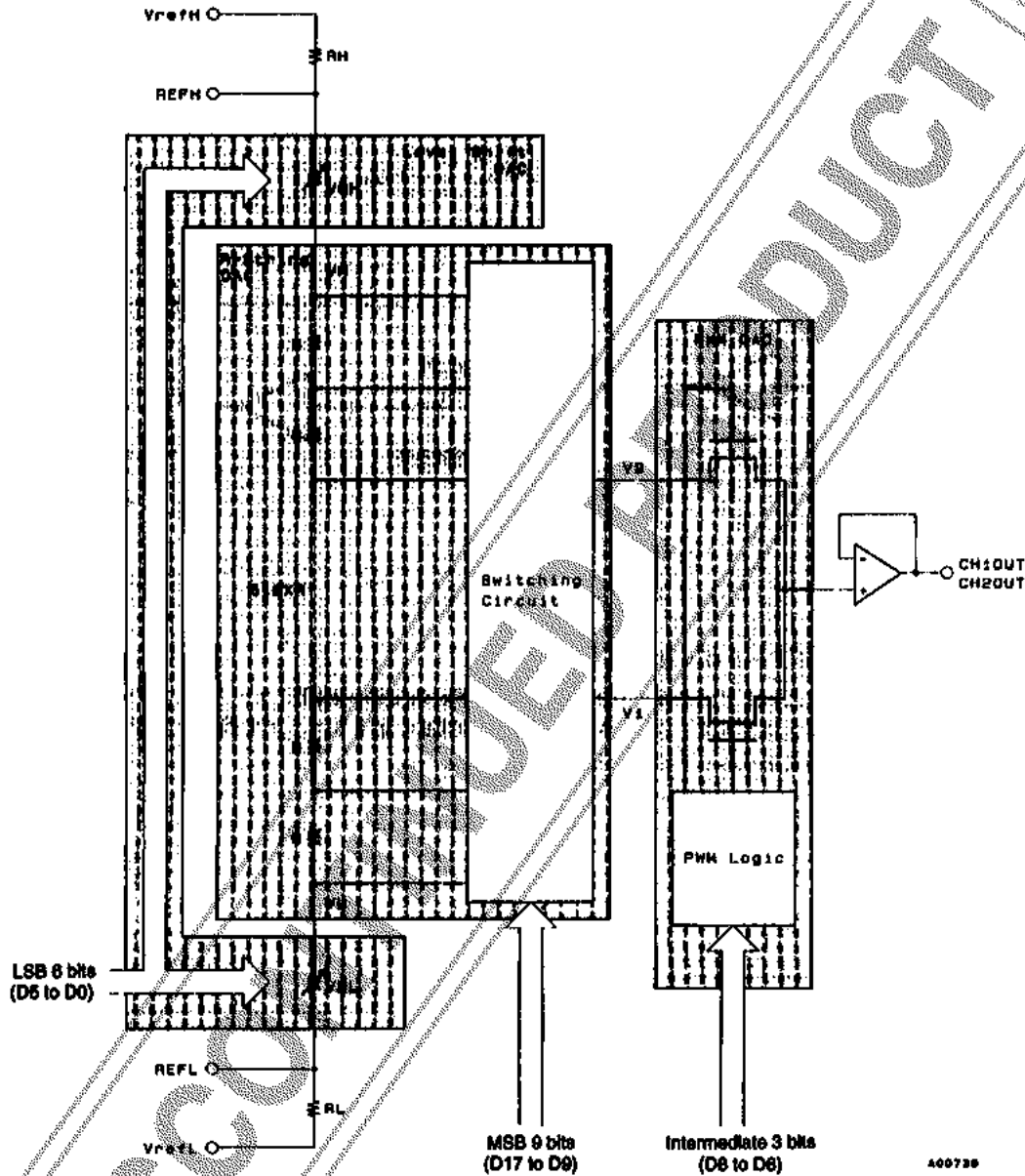

• Resistance String (R-string) D/A Converter

This 9-bit D/A converter circuit has 512 ($=2^9$) unit resistors (R) connected in series so that a potential applied to both ends is subjected to 512-way division. The two adjoining potentials $V2$ and $V1$ of the divided potentials corresponding to the values of the 9 MSBs of data ($D15$ to $D9$) are sent via a switching circuit to the PWM D/A converter. At this point, $V2 - V1 = (VH - VL)/512$.

- Pulse-Width Modulation (PWM) D/A Converter

This is a 3-bit circuit that applies pulse width modulation to voltages V2 and V1 output from the R-string D/A converter to produce an 8-way division. Depending on the value of the data in bits D8 to D6, one of the voltages, V2 or V1, is output to the CH1OUT (or CH2OUT) pin.

- Level Shift D/A Converter

The variable resistors VRH and VRL are connected in series to the two ends of the R-string D/A converter resistance, configuring a 6-bit D/A conversion circuit. Depending on the values of the data in the LSBs (bits D5 to D0), VRH and VRL change as follows.

- (1) The sum of VRH and VRL is constant, irrespective of the data value.
- (2) Irrespective of the data value, VRH and VRL are in the range of 0 to $63R/512$ (where R is the unit resistance of the R-string D/A converter) and resistance changes in $R/512$ steps in accordance with the data value.

This means that the R-string D/A converter outputs, V2 and V1, each vary in the range of 0 to $63 \times \Delta V/512$ ($\Delta V = (VH - VL)/512$) in $\Delta V/512$ steps.

- Vref H/L, REF H/L Pins

The voltage on the Vref pins, used to apply the reference voltage to the resistance strings, are usually set so that $V_{refH} = AV_{DD}$ and $V_{refL} = AGND$. In addition, a $10 \mu F$ rated condenser connects REFH and AGND as well as REFL and AGND. When $V_{refH} = 5.0 V$, $V_{refL} = 0 V$, the LC78835K on-chip RH and RL resistors maximum output amplitude at 0 dB playback is output in the 3.0 V_{p-p} range extending from a minimum 0.6 V to maximum 3.6 V.

DISCONTINUED PRODUCT

Filter Characteristics (theoretical values)

Normal-rate mode: 8 fs oversampling
 Double-rate mode: 4 fs oversampling
 Ripple: within ± 0.05 dB
 Attenuation amount: -40 dB or less

•Normal Rate (De-emphasis Off)

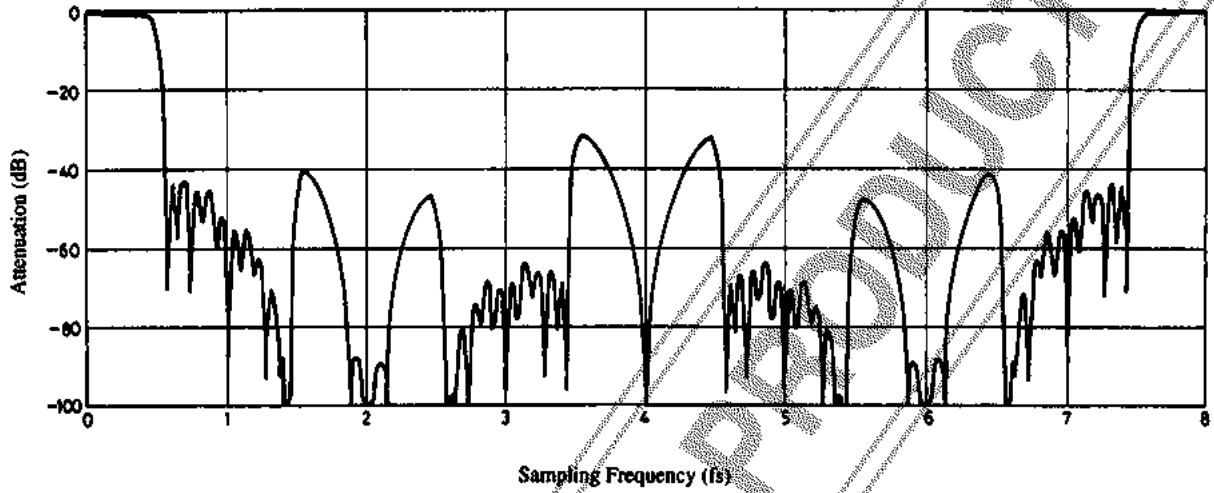

•Double Rate (De-emphasis Off)

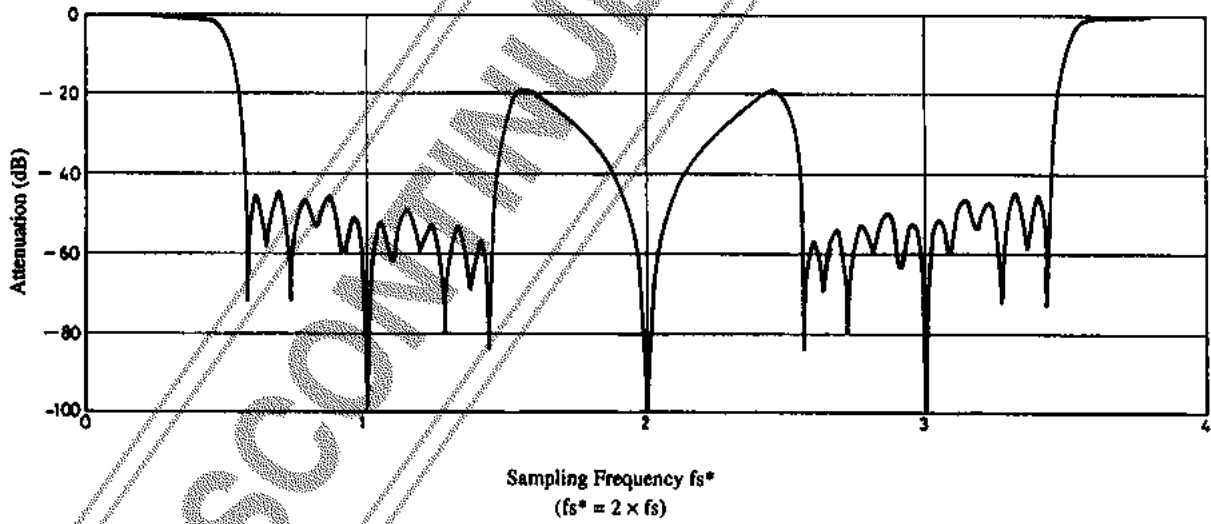

Pass Band Characteristics with De-emphasis On

- Normal Rate

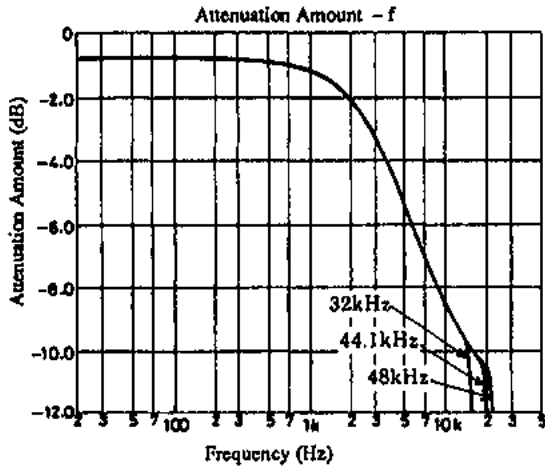

- Double Rate

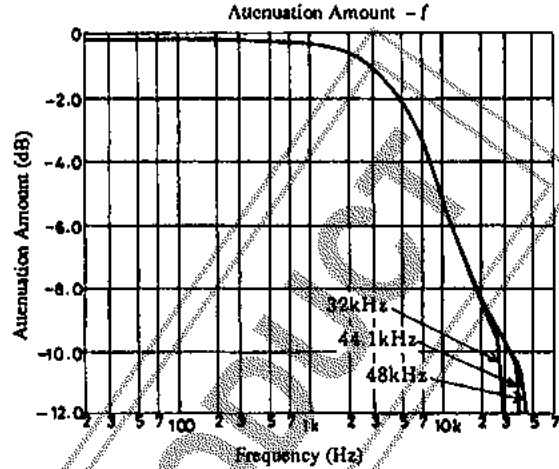

Sample Application Circuit

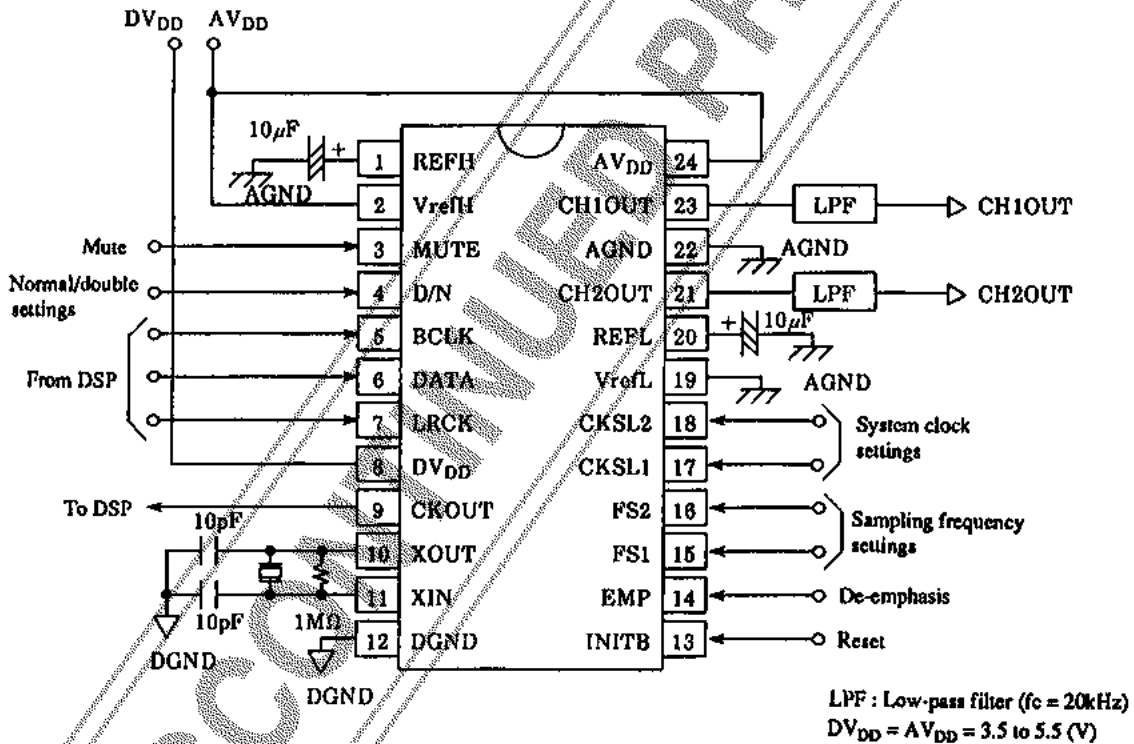

Note: 1. Within the sample application circuit, DV_{DD} connects to DGND as the digital ground, and AV_{DD} connects to AGND as the analog ground.

2. For AV_{DD} and V_{refH}, a low-impedance high-stability power supply (commercially available 3-pin regulator or compatible) should be used.

3. If 8-pin (DV_{DD}) and 24-pin (AV_{DD}) rise timings deviate, latch-up may occur. For this reason, no difference should exist between 8 and 24 pin power application timing.

4. A clock signal must be supplied to the XIN pin immediately after power is applied. The IC may be destroyed if the XIN pin is held either high or low when power is applied.

DISCONTINUED PRODUCT

- No products described or contained herein are intended for use in surgical implants, life-support systems, aerospace equipment, nuclear power control systems, vehicles, disaster/crime-prevention equipment and the like, the failure of which may directly or indirectly cause injury, death or property loss.
- Anyone purchasing any products described or contained herein for an above-mentioned use shall:
 - ① Accept full responsibility and indemnify and defend SANYO ELECTRIC CO., LTD., its affiliates, subsidiaries and distributors and all their officers and employees, jointly and severally, against any and all claims and litigation and all damages, cost and expenses associated with such use;
 - ② Not impose any responsibility for any fault or negligence which may be cited in any such claim or litigation on SANYO ELECTRIC CO., LTD., its affiliates, subsidiaries and distributors or any of their officers and employees jointly or severally.
- Information (including circuit diagrams and circuit parameters) herein is for example only; it is not guaranteed for volume production. SANYO believes information herein is accurate and reliable, but no guarantees are made or implied regarding its use or any infringements of intellectual property rights or other rights of third parties.

This catalog provides information as of July, 1996. Specifications and information herein are subject to change without notice.