

TC9270F, TC9270N

Σ - Δ MODULATION SYSTEM DA CONVERTER WITH A BUILT-IN DIGITAL ATTENUATOR DIGITAL FILTER

TC9270F, TC9270N are a 2nd order Σ - Δ modulation system 1-bit DA converter with a built-in 8 times over sampling FIR type digital filter developed for digital audio equipment.
As the de-emphasis filter has been incorporation, it is possible to construct small the digital filter ~ the analog output unit at a low price.

FEATURES

- Built-in 8 times over-sampling FIR type digital filter.
- Over sampling ratio (OSR) of Σ - Δ modulation circuit is 384fs or 256fs.
- Built-in digital de-emphasis filter.
- Permits microcontrollers to attenuate output levels (128 steps) during serial mode.
- Simultaneous outputs L-ch and R-ch.
- Compatible with double speed operation.
- Built-in Digital 0 Detection.
- Pin of OSCE can be stopped system clock.
- Characteristics of the digital filter and DA converter are as follows.

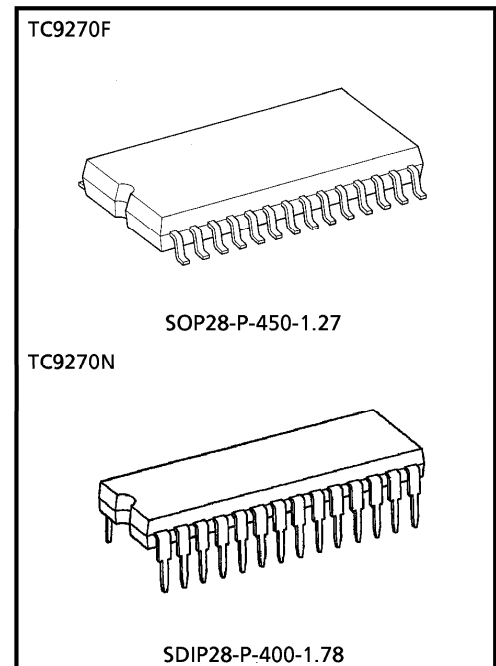

Weight
SOP28-P-450-1.27 : 0.8g (Typ.)
SDIP28-P-400-1.78 : 2.2g (Typ.)

DIGITAL FILTER

	DIGITAL FILTER	PASS-BAND RIPPLE	TRANSIENT BAND WIDTH	STOP-BAND SUPPRESSION
Standard Operation	8fs	± 0.003dB	20k~24.1kHz	- 68dB
Double Speed Operation	4fs	± 0.05dB	20k~24.1kHz	- 40dB

DA CONVERTER

	OSR	NOISE DISTORTION	S/N RATIO
Standard Operation	384fs	- 90dB (TYP)	100dB (TYP)
Double Speed Operation	192fs	- 87dB (TYP)	98dB (TYP)

- 2 kinds of package, Pin 28 flat package and Pin 28 DIP shrunk package.

980910EBA1

- TOSHIBA is continually working to improve the quality and the reliability of its products. Nevertheless, semiconductor devices in general can malfunction or fail due to their inherent electrical sensitivity and vulnerability to physical stress. It is the responsibility of the buyer, when utilizing TOSHIBA products, to observe standards of safety, and to avoid situations in which a malfunction or failure of a TOSHIBA product could cause loss of human life, bodily injury or damage to property. In developing your designs, please ensure that TOSHIBA products are used within specified operating ranges as set forth in the most recent products specifications. Also, please keep in mind the precautions and conditions set forth in the TOSHIBA Semiconductor Reliability Handbook.
- The products described in this document are subject to the foreign exchange and foreign trade laws.
- The information contained herein is presented only as a guide for the applications of our products. No responsibility is assumed by TOSHIBA CORPORATION for any infringements of intellectual property or other rights of the third parties which may result from its use. No license is granted by implication or otherwise under any intellectual property or other rights of TOSHIBA CORPORATION or others.
- The information contained herein is subject to change without notice.

PIN CONNECION

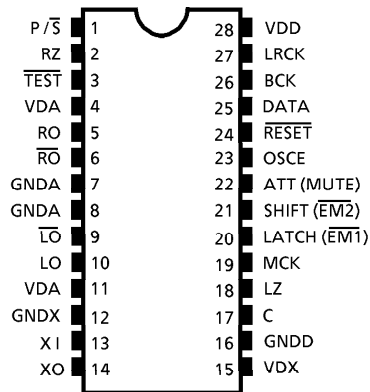

BLOCK DIAGRAM

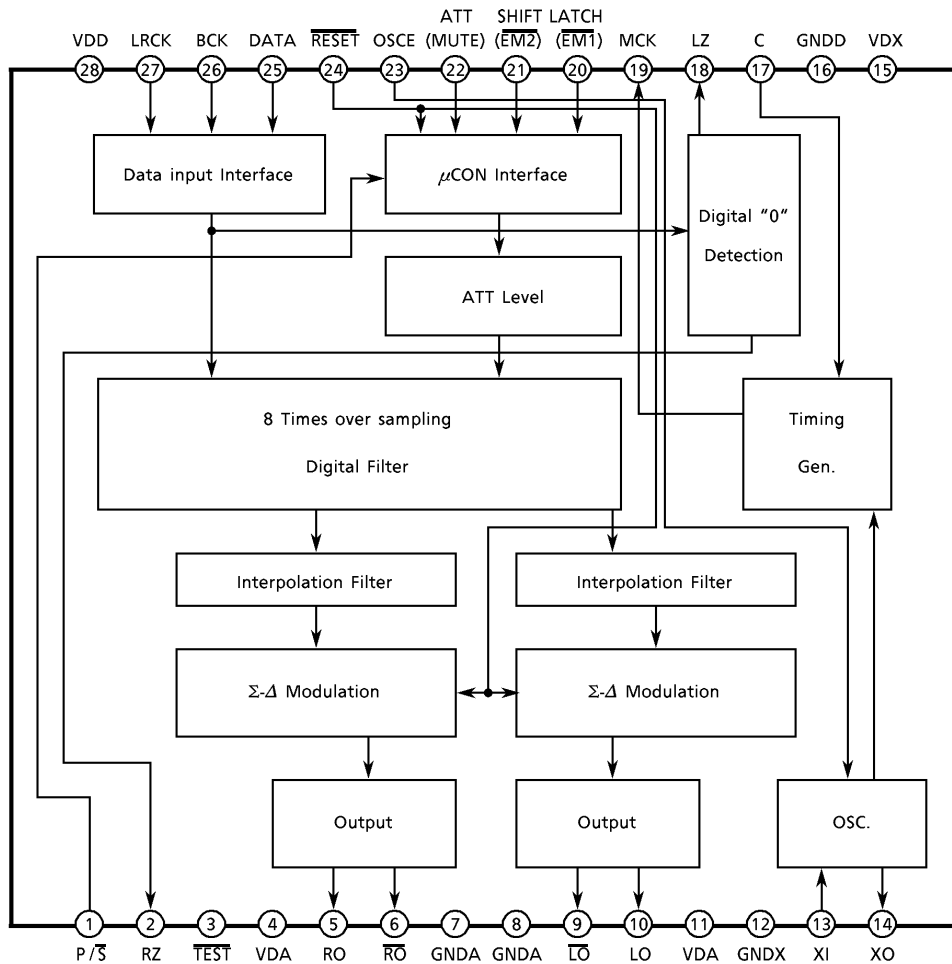

DESCRIPTION OF PIN FUNCTIONS

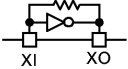
No.	SYMBOL	I/O	FUNCTION & OPERATION	REMARKS
1	P/S	I	Parallel control, serial control, switching pin.	Pull-up resistance
2	RZ	O	R-ch digital "0" detection output pin.	
3	$\overline{\text{TEST}}$	I	Test pin. Normally, use at "H".	Pull-up resistance
4	VDA	—	Analog power supply pin.	
5	RO	O	R-ch data forward output pin.	
6	$\overline{\text{RO}}$	O	R-ch data reverse output pin.	
7	GNDA	—	Analog ground pin.	
8	GNDA	—	Analog ground pin.	
9	$\overline{\text{LO}}$	O	L-ch data reverse output pin.	
10	LO	O	L-ch data forward output pin.	
11	VDA	—	Analog power supply pin.	
12	GNDX	—	Crystal oscillator ground Pin.	
13	XI	I	Crystal oscillator connection pin.	
14	XO	O	Connect to a crystal oscillator, generates needed frequency for the system.	
15	VDX	—	Crystal oscillator power supply pin.	
16	GNDD	—	Digital ground pin.	
17	C	I	Clock Select pin. "L" ; 256fs, "H" ; 384fs.	Pull-up resistance
18	LZ	O	L-ch digital "0" detection output pin.	
19	MCK	O	System clock output pin.	
20	LATCH (EM1)	I	Serial mode : Data latch signal input pin. Parallel mode : De-emphasis filter mode select pin.	Pull-up resistance
21	SHIFT (EM2)	I	Serial mode : Shift clock input pin. Parallel mode : De-emphasis filter mode select pin.	Pull-up resistance
22	ATT (MUTE)	I	Serial mode : Data input pin. Parallel mode : Soft mute control pin. ("H" Soft mute ON)	Pull-up resistance
23	OSCE	I	System clock control pin. "L" : System clock stop	Pull-up resistance
24	$\overline{\text{RESET}}$	I	Reset pin. "L" : Reset Σ - Δ circuit and ATT data 00 (HEX)	Pull-up resistance
25	DATA	I	Audio data input pin.	
26	BCK	I	Bit clock input pin.	
27	LRCK	I	LR clock input pin.	
28	VDD	—	Digital power supply pin.	

OPERATION DESCRIPTION FOR EACH BLOCK

1. CRYSTAL OSCILLATION CIRCUIT AND TIMING GENERATOR

Clock required for internal operation can be generated when crystal and capacitors are connected as shown in FIG.1 So external system clock signal may be applied to the X1 terminal at Pin 13. However care must be taken in using system clock since the S/N ratio and noise distortion performance can be greatly affected by Jitter, rise and fall characteristics...etc. of system clock.

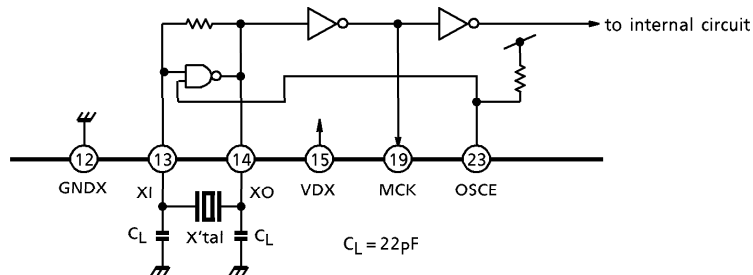

Use crystal with Low CI value and quick response.

FIG.1 Configuration of crystal oscillation circuit

The timing generator generates the timing signal for digital filter, digital attenuator, de-emphasis filter Σ - Δ demodulator circuit.

C (Pin 17)	XI INPUT CLOCK
L	256fs
H	384fs

Internal system clock can be stopped by OSCE pin but output of DAC will become unstable.

OSCE (Pin 23)	SYSTEM CLOCK
L	Stop
H	Normal operation

2. DATA INPUT CIRCUIT

Data and LRCK are taken into the shift register at the leading edge of BCK. As shown in the following timing example, it is necessary to input data and LRCK synchronized with the falling edge of BCK. In parallel mode ($P/\bar{S} = "H"$), input data length is fixed to 16 bits. In serial mode ($P/\bar{S} = "L"$), input data length can be selected to 16, 18, or 20bits.

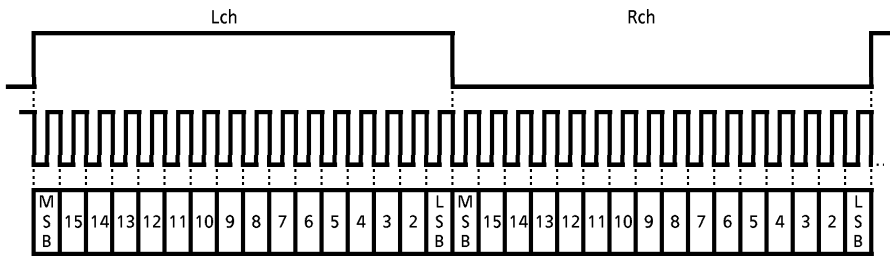

FIG.2a Example of input timing diagram (16 bit Input)

If BCK is 48fs or 64fs, please input DATA as follows.

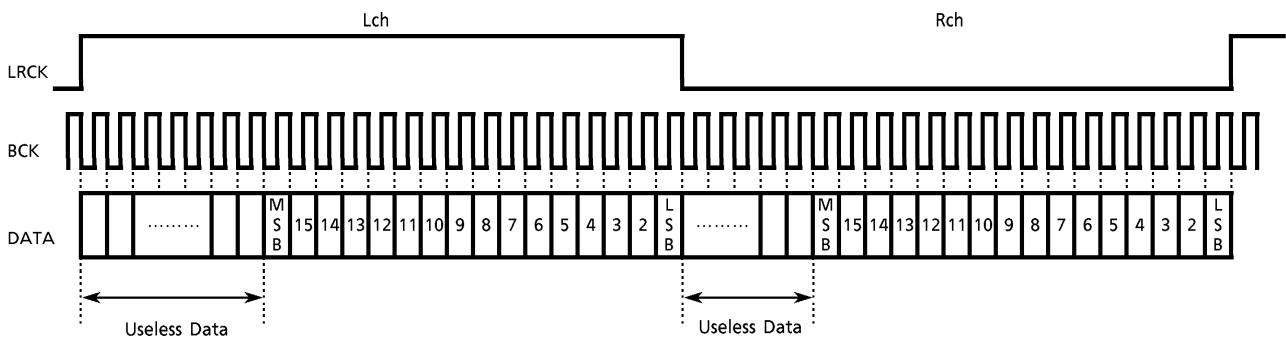

FIG.2b Example of input timing diagram (16 bit input)
When BCK = 48fs or 64fs.

MAXIMUM RATINGS (Ta = 25°C)

CHARACTERISTIC	SYMBOL	RATING	UNIT
Power Supply Voltage	VDD	-0.3~6.0	V
	VDA	-0.3~6.0	V
	VDX	-0.3~6.0	V
Input Voltage	Vin	-0.3~VDD + 0.3	V
Power Dissipation	PD	TC9270F : 600	mW
		TC9270N : 800	
Operating Temperature	T _{opr}	-35~85	°C
Storage Temperature	T _{stg}	-55~150	°C

ELECTRICAL CHARACTERISTICS (Unless otherwise specified, Ta = -35~85°C VDD = VDX = VDA = 5V)

DC CHARACTERISTICS

CHARACTERISTIC	SYMBOL	TEST CIR-CUIT	TEST CONDITION	MIN	TYP.	MAX	UNIT
Power Supply Voltage	VDD	—	Ta = -35~85°C	4.5	5.0	5.5	V
	VDX			4.5	5.0	5.5	
	VDA			4.5	5.0	5.5	
Power Dissipation	IDD	—	XI = 16.9MHz	—	30	40	mA
Input Voltage	"H" Level	V _{IH}	—	VDD × 0.7	—	VDD	V
	"L" Level	V _{IL}		0.0	—	VDD × 0.3	
Input Current	"H" Level	I _{IH}	—	-1.0	—	1.0	μA
	"L" Level	I _{IL}					
Pull-up Resiso	RUP	—	1, 3, 17, 20, 21, 22, 23, Pin 24 Ta = 25°C, at 0V force measure current.	100	150	300	kΩ

AC CHARACTERISTICS (*) : Ta = 25°C

CHARACTERISTIC	SYMBOL	TEST CIR-CUIT	TEST CONDITION	MIN	TYP.	MAX	UNIT
Noise Distortion (*)	THD + N	1	1kHz Sine wave, full-scale input	—	-90	-85	dB
S/N Ratio (*)	S/N	1		95	100	—	dB
Dynamic Range (*)	DR	1	1kHz Sine wave, -60 Input Conversion	90	95	—	dB
Cross-talk (*)	CT	1	1kHz Sine wave, full-scale input	—	-95	-90	dB
Operating Frequency	f _{opr}	—		10	16.9344	19.2	MHz
Input Frequency	f _{LR}	—	LRCK duty cycle = 50%	30	44.1	100	kHz
	f _{BCK}		BCK duty cycle = 50%	0.96	1.4112	6.2	MHz
Rise Time	t _r	—	LRCK, BCK (10%~90%)	—	—	15	nS
Fall Time	t _f			—	—	15	nS
Delay Time	t _d	—	BCK Edge → LRCK, DATA	-50	—	50	nS

- **TEST CIRCUIT - 1 ;** Application Circuit Example 1 is used.

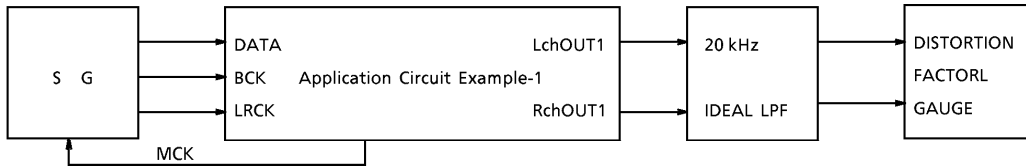

SG : ANRITSU MG-22A or equivalent
 LPF : SHIBASOKU 725C Built-In Filter
 Distortion Factor Gauge : SHIBASOKU 725C or equivalent

Measuring Item	Distortion factor gauge filter setting A weight
THD + N, CT	OFF
S/N, DR	ON

A weight : IEC - A or equivalent

- **AC CHARACTERISTIC POINT ;** (Input signal ; LRCK、BCK、 DATA)

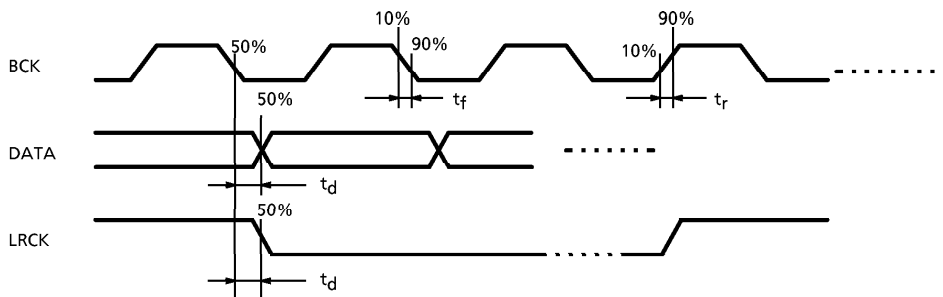

PACKAGE DIMENSIONS
SOP28-P-450-1.27

Unit : mm

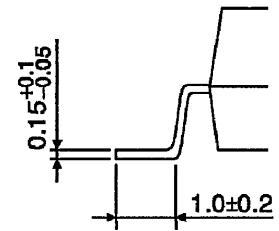
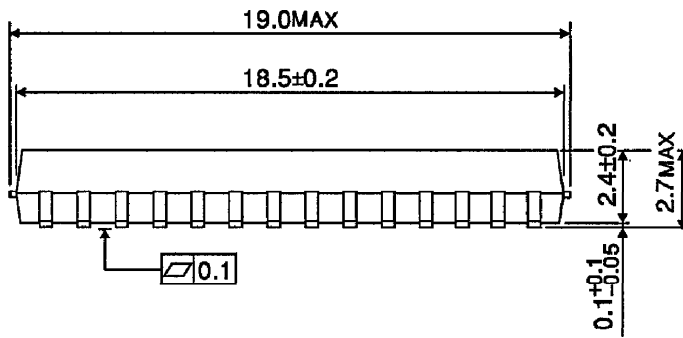
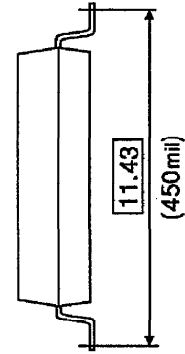
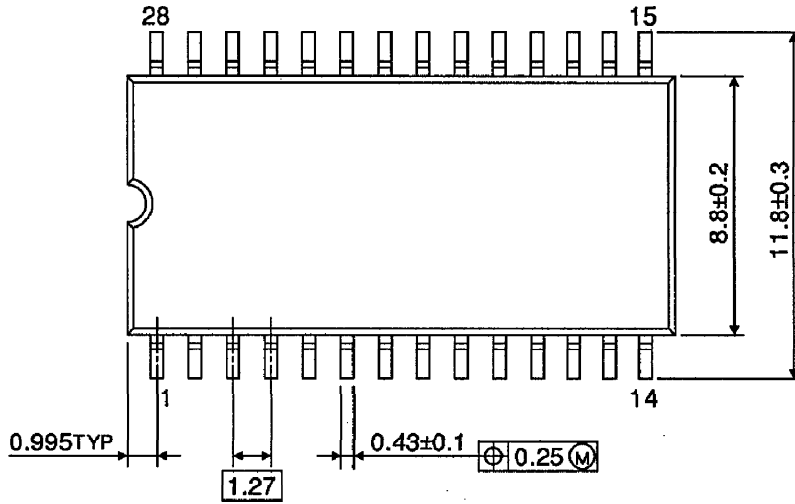

Weight : 0.8g (Typ.)

PACKAGE DIMENSIONS
SDIP28-P-400-1.78

Unit : mm

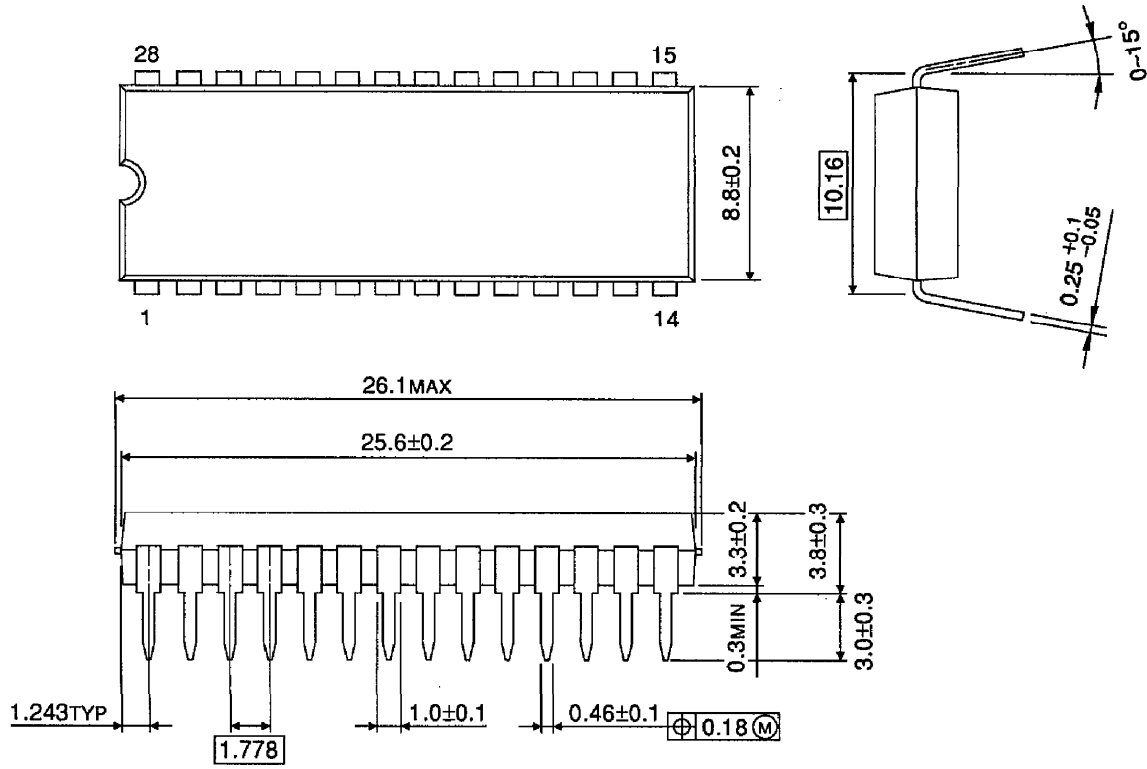

Weight : 2.2g (Typ.)