

# MBRM140T3

*Advance Information*

## Surface Mount Schottky Power Rectifier

**POWERMITE®**

### Power Surface Mount Package

The Schottky Powermite employs the Schottky Barrier principle with a barrier metal and epitaxial construction that produces optimal forward voltage drop–reverse current tradeoff. The advanced packaging techniques provide for a highly efficient micro miniature, space saving surface mount Rectifier. With its unique heatsink design, the Powermite has the same thermal performance as the SMA while being 50% smaller in footprint area, and delivering one of the lowest height profiles, < 1.1 mm in the industry. Because of its small size, it is ideal for use in portable and battery powered products such as cellular and cordless phones, chargers, notebook computers, printers, PDAs and PCMCIA cards. Typical applications are ac/dc and dc–dc converters, reverse battery protection, and “Oring” of multiple supply voltages and any other application where performance and size are critical.

#### Features:

- Low Profile — Maximum Height of 1.1 mm
- Small Footprint — Footprint Area of 8.45 mm<sup>2</sup>
- Low  $V_F$  Provides Higher Efficiency and Extends Battery Life
- Supplied in 12 mm Tape and Reel — 12,000 Units per Reel
- Low Thermal Resistance with Direct Thermal Path of Die on Exposed Cathode Heat Sink

#### Mechanical Characteristics:

- Powermite is JEDEC Registered as D0–216AA
- Case: Molded Epoxy
- Epoxy Meets UL94, VO at 1/8”
- Weight: 62 mg (approximately)
- Device Marking: BCJ
- Lead and Mounting Surface Temperature for Soldering Purposes. 260°C Maximum for 10 Seconds

This document contains information on a new product. Specifications and information herein are subject to change without notice.



**ON Semiconductor**

Formerly a Division of Motorola

<http://onsemi.com>

### SCHOTTKY BARRIER RECTIFIER 1.0 AMPERES 40 VOLTS

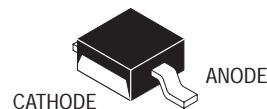

**PLASTIC  
CASE 457**

#### ORDERING INFORMATION

Device	Package	Shipping
MBRM140T3	Plastic	12,000 Units per 12 mm Tape & Reel

# MBRM140T3

## MAXIMUM RATINGS

Rating	Symbol	Value	Unit
Peak Repetitive Reverse Voltage Working Peak Reverse Voltage DC Blocking Voltage	$V_{RRM}$ $V_{RWM}$ $V_R$	40	V
Average Rectified Forward Current (At Rated $V_R$ , $T_C = 110^\circ\text{C}$ )	$I_O$	1.0	A
Peak Repetitive Forward Current (At Rated $V_R$ , Square Wave, 100 kHz, $T_C = 110^\circ\text{C}$ )	$I_{FRM}$	2.0	A
Non-Repetitive Peak Surge Current (Non-Repetitive peak surge current, halfwave, single phase, 60 Hz)	$I_{FSM}$	50	A
Storage Temperature	$T_{stg}$	-55 to 150	$^\circ\text{C}$
Operating Junction Temperature	$T_J$	-55 to 125	$^\circ\text{C}$
Voltage Rate of Change (Rated $V_R$ , $T_J = 25^\circ\text{C}$ )	$dv/dt$	10,000	$\text{V}/\mu\text{s}$

## THERMAL CHARACTERISTICS

Thermal Resistance – Junction-to-Lead (Anode) (1)	$R_{tjl}$	35	$^\circ\text{C}/\text{W}$
Thermal Resistance – Junction-to-Tab (Cathode) (1)	$R_{tjtab}$	23	
Thermal Resistance – Junction-to-Ambient (1)	$R_{tja}$	277	

(1) Mounted with minimum recommended pad size, PC Board FR4, See Figures 9 & 10.

## ELECTRICAL CHARACTERISTICS

Maximum Instantaneous Forward Voltage (2), See Figure 2  ( $I_F = 0.1 \text{ A}$ ) ( $I_F = 1.0 \text{ A}$ ) ( $I_F = 3.0 \text{ A}$ )	$V_F$	$T_J = 25^\circ\text{C}$	$T_J = 85^\circ\text{C}$	V
		0.36	0.30	
		0.55	0.515	
Maximum Instantaneous Reverse Current, See Figure 4  ( $V_R = 40 \text{ V}$ ) ( $V_R = 20 \text{ V}$ )	$I_R$	$T_J = 25^\circ\text{C}$	$T_J = 85^\circ\text{C}$	mA
		0.5	25	
		0.15	18	

(2) Pulse Test: Pulse Width  $\leq 250 \mu\text{s}$ , Duty Cycle  $\leq 2\%$ .

# MBRM140T3

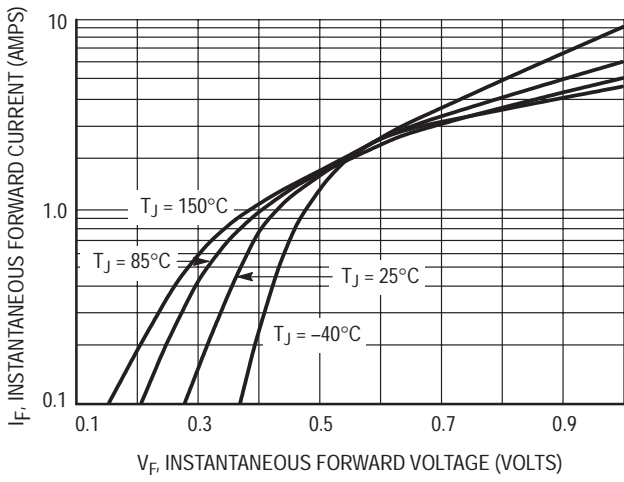

**Figure 1. Typical Forward Voltage**

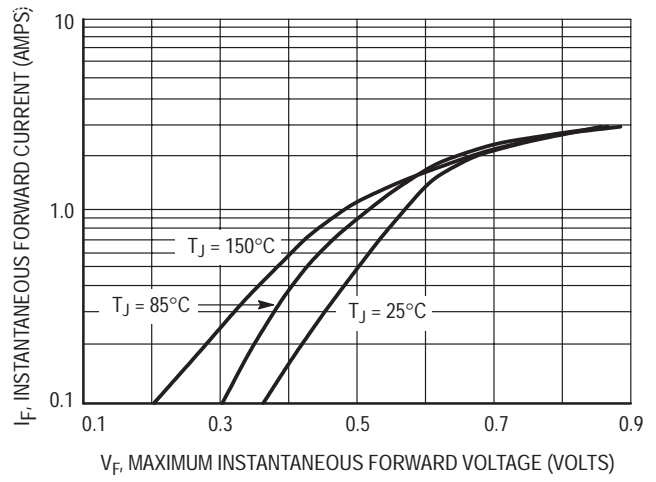

**Figure 2. Maximum Forward Voltage**

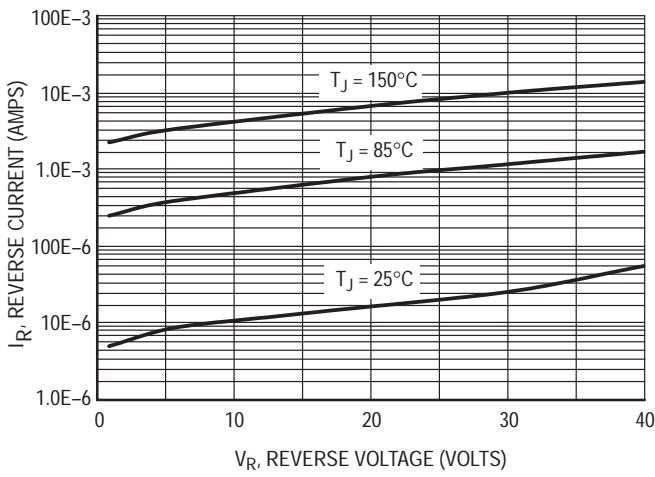

**Figure 3. Typical Reverse Current**

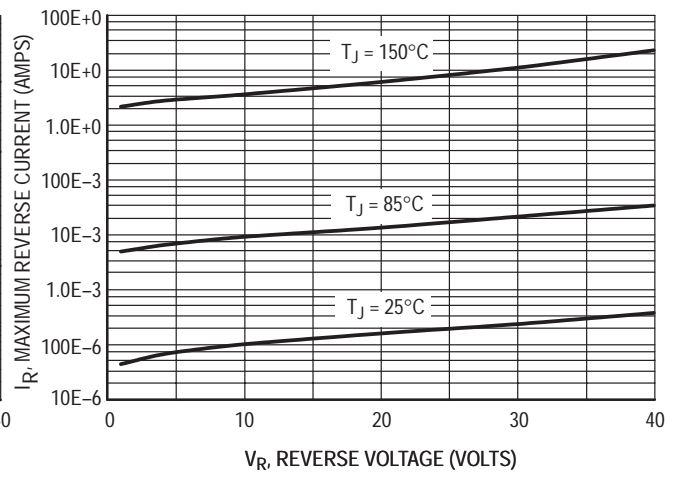

**Figure 4. Maximum Reverse Current**

# MBRM140T3

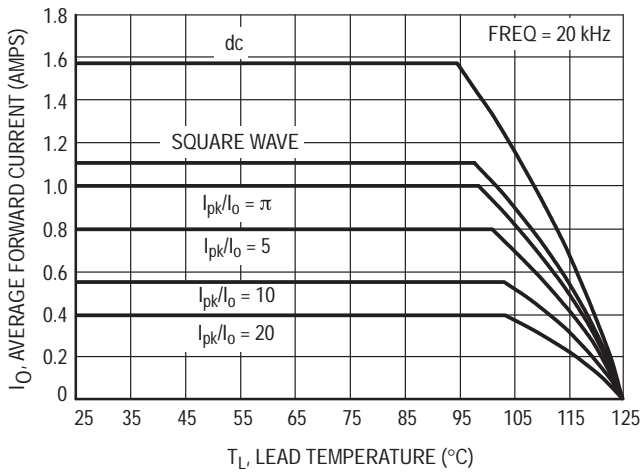

Figure 5. Current Derating

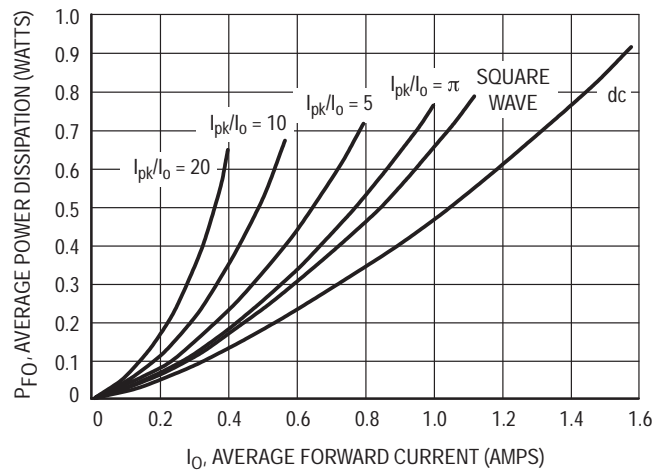

Figure 6. Forward Power Dissipation

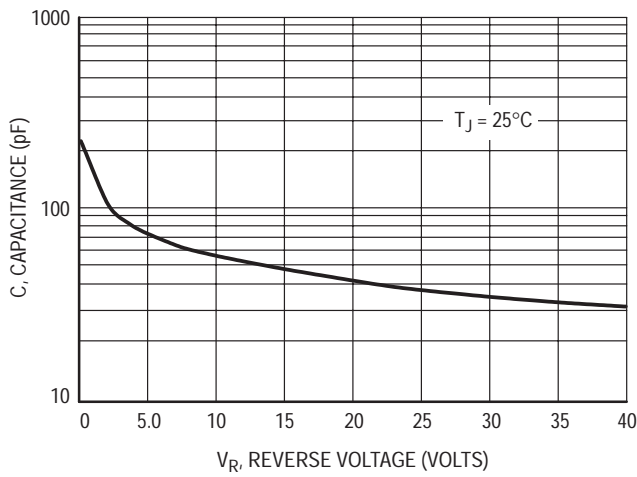

Figure 7. Capacitance

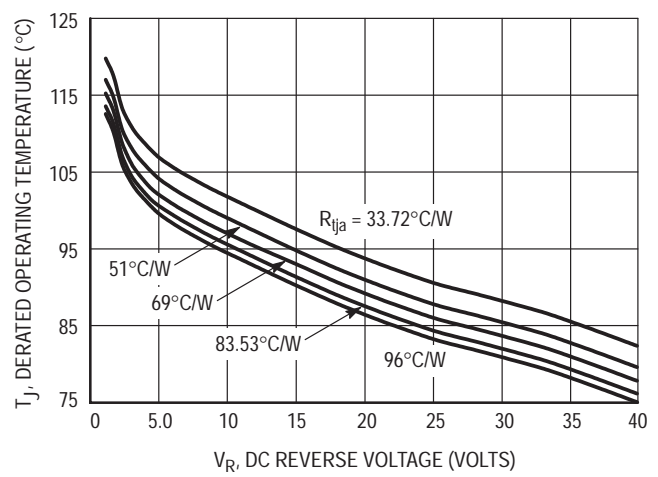

Figure 8. Typical Operating Temperature Derating\*

\* Reverse power dissipation and the possibility of thermal runaway must be considered when operating this device under any reverse voltage conditions. Calculations of  $T_J$  therefore must include forward and reverse power effects. The allowable operating  $T_J$  may be calculated from the equation:

$$T_J = T_{Jmax} - r(t)(P_f + P_r) \text{ where}$$

$r(t)$  = thermal impedance under given conditions,  
 $P_f$  = forward power dissipation, and  
 $P_r$  = reverse power dissipation

This graph displays the derated allowable  $T_J$  due to reverse bias under DC conditions only and is calculated as  $T_J = T_{Jmax} - r(t)P_r$ , where  $r(t) = R_{thja}$ . For other power applications further calculations must be performed.

# MBRM140T3

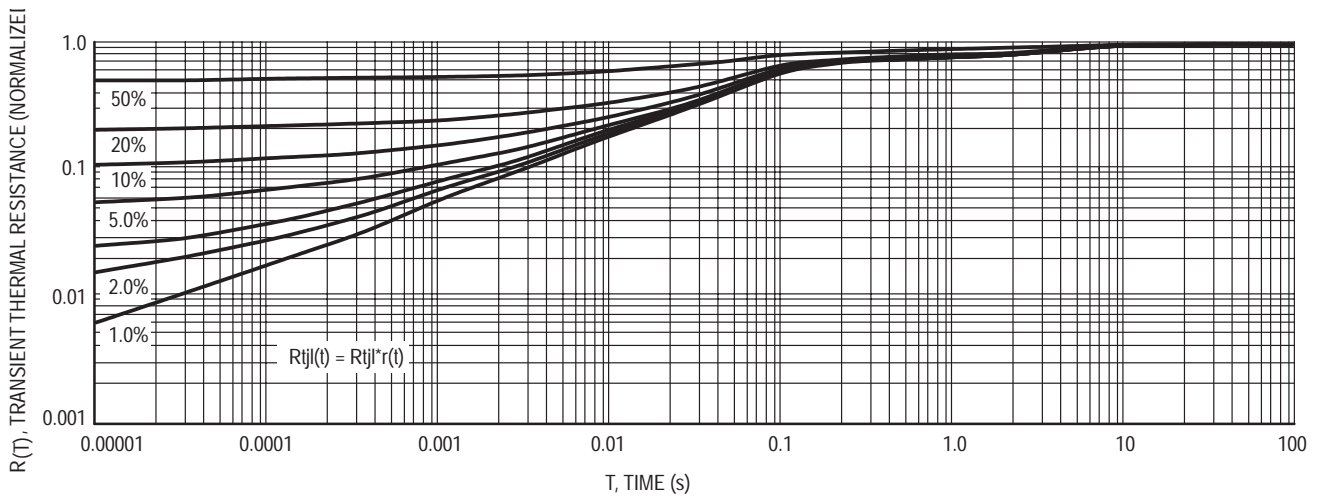

Figure 9. Thermal Response Junction to Lead

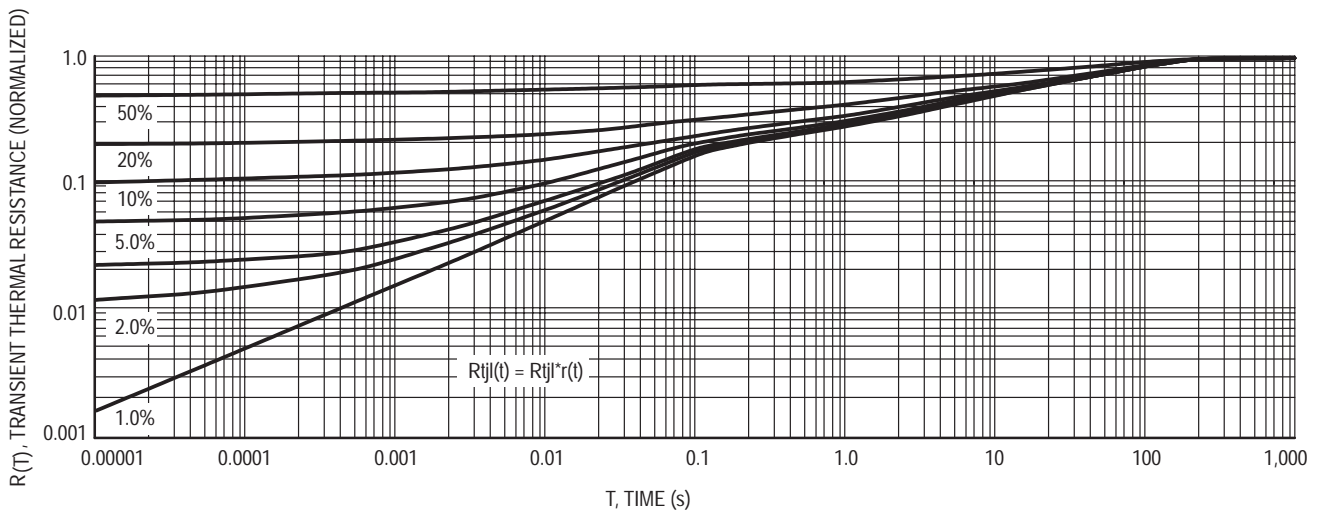
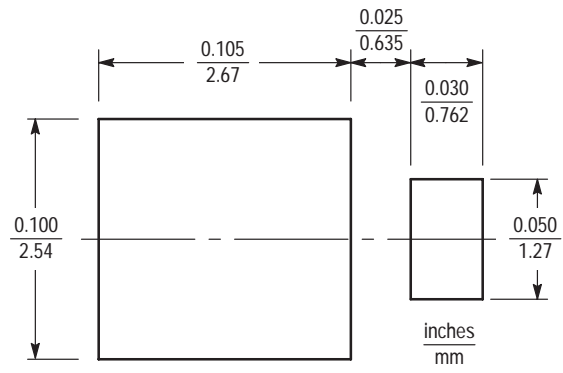

Figure 10. Thermal Response Junction to Ambient

# MBRM140T3



**Minimum Recommended Footprint**

# MBRM140T3

## PACKAGE DIMENSIONS

N SUFFIX  
 PLASTIC PACKAGE  
 CASE 457-04  
 ISSUE C

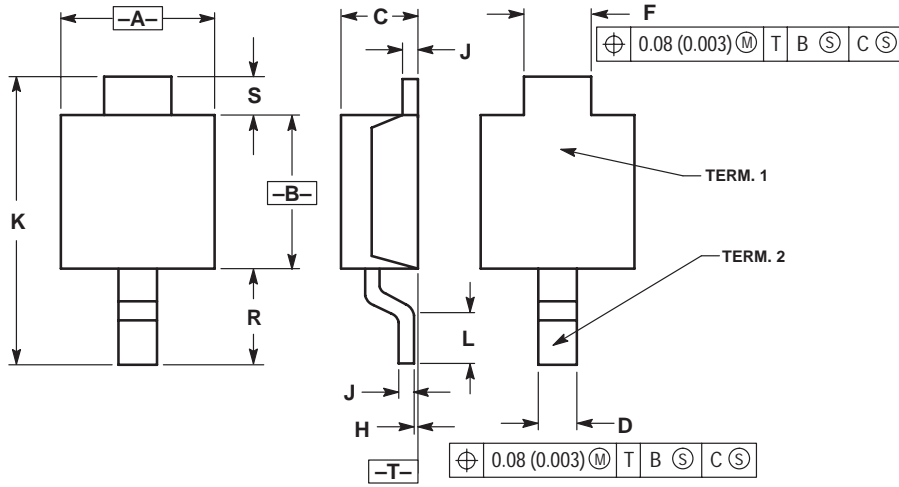

NOTES:

1. DIMENSIONING AND TOLERANCING PER ANSI Y14.5M, 1982.
2. CONTROLLING DIMENSION: MILLIMETER.
3. DIMENSION A DOES NOT INCLUDE MOLD FLASH, PROTRUSIONS OR GATE BURRS. MOLD FLASH, PROTRUSIONS OR GATE BURRS SHALL NOT EXCEED 0.15 (0.006) PER SIDE.

DIM	MILLIMETERS		INCHES	
	MIN	MAX	MIN	MAX
A	1.75	2.05	0.069	0.081
B	1.75	2.18	0.069	0.086
C	0.85	1.15	0.033	0.045
D	0.40	0.69	0.016	0.027
F	0.70	1.00	0.028	0.039
H	-0.05	+0.10	-0.002	+0.004
J	0.10	0.25	0.004	0.010
K	3.60	3.90	0.142	0.154
L	0.50	0.80	0.020	0.031
R	1.20	1.50	0.047	0.059
S	0.50	REF	0.019	REF

POWERMITE is a registered trademark of MicroSemi Corporation

**ON Semiconductor** and  are trademarks of Semiconductor Components Industries, LLC (SCILLC). SCILLC reserves the right to make changes without further notice to any products herein. SCILLC makes no warranty, representation or guarantee regarding the suitability of its products for any particular purpose, nor does SCILLC assume any liability arising out of the application or use of any product or circuit, and specifically disclaims any and all liability, including without limitation special, consequential or incidental damages. "Typical" parameters which may be provided in SCILLC data sheets and/or specifications can and do vary in different applications and actual performance may vary over time. All operating parameters, including "Typicals" must be validated for each customer application by customer's technical experts. SCILLC does not convey any license under its patent rights nor the rights of others. SCILLC products are not designed, intended, or authorized for use as components in systems intended for surgical implant into the body, or other applications intended to support or sustain life, or for any other application in which the failure of the SCILLC product could create a situation where personal injury or death may occur. Should Buyer purchase or use SCILLC products for any such unintended or unauthorized application, Buyer shall indemnify and hold SCILLC and its officers, employees, subsidiaries, affiliates, and distributors harmless against all claims, costs, damages, and expenses, and reasonable attorney fees arising out of, directly or indirectly, any claim of personal injury or death associated with such unintended or unauthorized use, even if such claim alleges that SCILLC was negligent regarding the design or manufacture of the part. SCILLC is an Equal Opportunity/Affirmative Action Employer.

## PUBLICATION ORDERING INFORMATION

### USA/EUROPE Literature Fulfillment:

Literature Distribution Center for ON Semiconductor  
P.O. Box 5163, Denver, Colorado 80217 USA  
**Phone:** 303-675-2175 or 800-344-3860 Toll Free USA/Canada  
**Fax:** 303-675-2176 or 800-344-3867 Toll Free USA/Canada  
**Email:** ONlit@hibbertco.com

**Fax Response Line\*:** 303-675-2167  
800-344-3810 Toll Free USA/Canada  
\*To receive a Fax of our publications

**N. America Technical Support:** 800-282-9855 Toll Free USA/Canada

### ASIA/PACIFIC: LDC for ON Semiconductor – Asia Support

**Phone:** 303-675-2121 (Tue-Fri 9:00am to 1:00pm, Hong Kong Time)  
**Email:** ONlit-asia@hibbertco.com

**JAPAN:** ON Semiconductor, Japan Customer Focus Center  
4-32-1 Nishi-Gotanda, Shinagawa-ku, Tokyo, Japan 141-8549

**Phone:** 81-3-5487-8345  
**Email:** r14153@onsemi.com

**ON Semiconductor Website:** <http://onsemi.com>

For additional information, please contact your local Sales Representative.