

Sound control IC

BH3852S / BH3852FS

The BH3852S and BH3852FS are signal processing ICs designed for volume and tone control in CD radio cassettes and other audio products. They can be used without a microcomputer because they use DC current for control.

●Applications

CD radio cassettes, micro components, car stereos, televisions

●Features

- 1) Can control volume (main volume) and tone (bass, treble).
- 2) Volume is produced by a low-distortion, low-noise VCA, is controlled with DC current, and, due to an internal reference voltage with temperature compensation, can control two channels with a single variable resistor.
- 3) Input amp can be used for gain adjustment, and matrix surround yields powerful sound.

●Absolute maximum ratings (Ta = 25°C)

Parameter	Symbol	Limits	Unit
Power supply voltage	Vcc	10.0	V
Power dissipation	BH3852S	1050*1	mW
	BH3852FS	800 *2	
Operating temperature	Topr	-40~+85	°C
Storage temperature	Tstg	-55~+125	°C

*1 Reduced by 10.5mW for each increase in Ta of 1°C over 25°C.

*2 Reduced by 8mW for each increase in Ta of 1°C over 25°C.

●Recommended operating conditions

Parameter	Symbol	Min.	Typ.	Max.	Unit
Power supply voltage	Vcc	5.4	—	9.5	V

● Block diagram

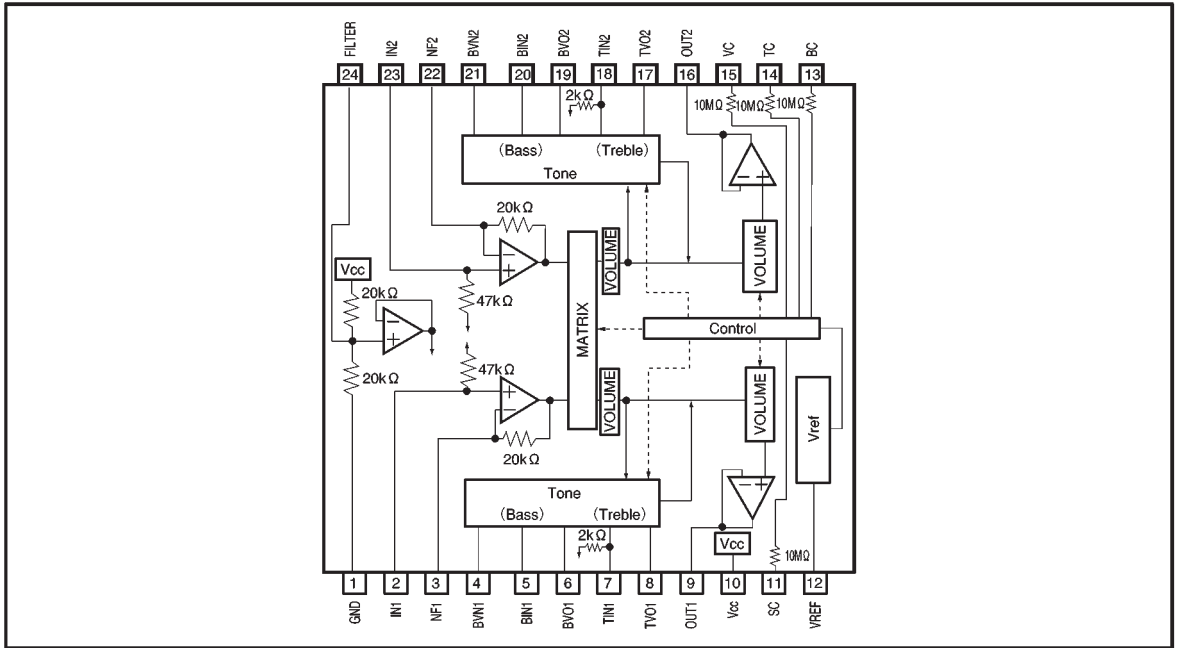

● Pin descriptions

Pin No.	Pin name	Function	Pin No.	Pin name	Function
1	GND	Ground	13	BC	Bass control pin
2	IN1	Channel 1 volume input	14	TC	Treble control pin
3	NF1	Input-stage amplifier gain setting	15	VC	Volume control pin
4	BVN1	Channel 1 bass filter	16	OUT2	Channel 2 volume output
5	BIN1	Channel 1 bass filter	17	TVO2	Channel 2 treble filter
6	BVO1	Channel 1 bass filter	18	TIN2	Channel 2 treble filter
7	TIN1	Channel 1 treble filter	19	BVO2	Channel 2 bass filter
8	TVO1	Channel 1 treble filter	20	BIN2	Channel 2 bass filter
9	OUT1	Channel 1 volume out	21	BVN2	Channel 2 bass filter
10	V _{CC}	Power supply	22	NF2	Input-stage amplifier gain stage
11	SC	Surround control pin	23	IN2	Channel 2 volume input
12	VREF	Reference voltage output	24	FILTER	Filter pin

● Input / output circuits

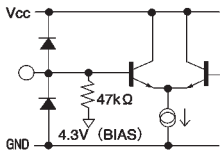
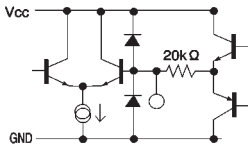
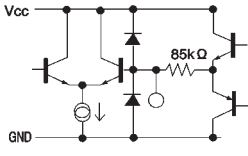
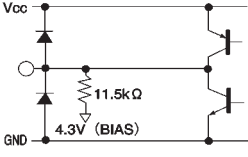
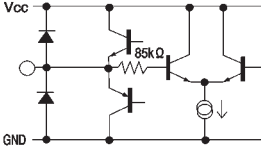
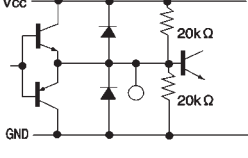
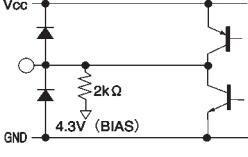
Symbol	Pin no.	Pin voltage	Equivalent circuit	Pin description
IN1 IN2	2pin 23pin	4.3V 4.3V		Main volume input pin. Designed for input impedance of 47 kΩ (Typ.)
NF1 NF2	3pin 22pin	4.3V 4.3V		Pin for adjustment of input amp gain. Approximately +6 dB with connection of 20 kΩ resistance.
BVN1 BVN2	4pin 21pin	4.3V 4.3V		Pin for low band filter connection.
BIN1 BIN2	5pin 20pin	4.3V 4.3V		Pin for low band filter connection.
BV01 BV02	6pin 19pin	4.3V 4.3V		Pin for low band filter connection.
FILTER	24pin	4.0V		Filter input pin. Filter input pin designed to operate at approximately 1/2 Vcc. Please install a capacitor of about 10 μF to the filter pin. Has built-in precharge and discharge circuits.
TIN1 TIN2	7pin 18pin	4.3V 4.3V		Pin for high band filter connection.

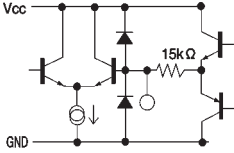
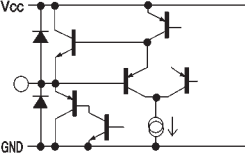
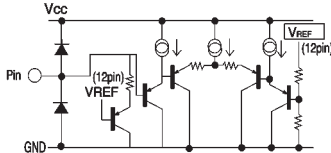
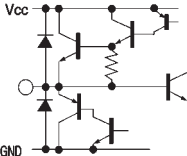
Symbol	Pin no.	Pin voltage	Equivalent circuit	Pin description
TV01 TV02	8pin 17pin	4.3V 4.3V		Pin for high band filter connection.
OUT1 OUT2	9pin 16pin	4.0V 4.0V		Main volume output pin. OUT1 is the volume output for ch1. OUT2 is the volume output for ch2.
SC BC TC VC	11pin 13pin 14pin 15pin	—		VC: Volume pin TC: Treble pin BC: Bass pin SC: Surround pin
VREF	12pin	3.8V		Regulator output pin. Output requires capacitor for stopping oscillation. Output pin has built-in precharge and discharge circuits, so there is no problem when turned on or off, even with a large capacitor.
Vcc	10pin	8V	Power supply voltage pin.	
GND	1pin	0V	GND pin. Connected to IC board.	

Note: All figures for pin voltage assume a power supply voltage (Vcc) of 8V.

- Electrical characteristics (unless otherwise noted, $T_a = 25^\circ\text{C}$, $V_{CC} = 8\text{V}$, $f = 1\text{kHz}$, $\text{BW} = 20 \sim 20\text{kHz}$,
 $\text{VOL} = \text{Max.}$, $\text{TONE} = \text{ALL FLAT}$, $R_g = 600\Omega$, $R_L = 10\text{k}\Omega$, $\text{INPUT_AMP_GAIN} = 0\text{dB}$)

Parameter	Symbol	Min.	Typ.	Max.	Unit	Conditions
Quiescent current	I_Q	8	17	25	mA	No signal
Maximum input	V_{im}	1.8	2.0	—	V_{rms}	THD=1%, VOL=-20dB(ATT)
Maximum output	V_{om}	1.8	2.0	—	V_{rms}	THD=1%
Voltage gain	G_V	-3.0	-1.0	1.0	dB	$V_{IN}=1V_{rms}$
Maximum attenuation	ATT	90	110	—	dB	$V_O=1V_{rms}$
Crosstalk	V_{CT}	57	67	—	dB	$V_O=1V_{rms}$, BPF=400Hz~30kHz
Low range control width	V_{Bmax}	12	15	18	dB	75Hz, $V_{IN}=100mV_{rms}$
	V_{Bmin}	-18	-15	-12	dB	75Hz, $V_{IN}=100mV_{rms}$
High range control width	V_{Tmax}	12	15	18	dB	10kHz, $V_{IN}=100mV_{rms}$
	V_{Tmin}	-18	-15	-12	dB	10kHz, $V_{IN}=100mV_{rms}$
Mute attenuation	V_{MT}	90	110	—	dB	$V_O=1V_{rms}$ *
Total Harmonic distortion	THD	—	0.03	0.1	%	$V_O=0.3V_{rms}$, BPF=400Hz~30kHz
Output noise voltage	V_{NO1}	—	25	35	μV_{rms}	No signal VOL=MAX, $R_g=0$ *
Output noise voltage during full boost	V_{NO2}	—	73	113	μV_{rms}	No signal TONE=ALL MAX, VOL=MAX, $R_g=0$ *
Residual output noise voltage	V_{MNO}	—	2	10	μV_{rms}	No signal VOL=-∞, $R_g=0$ *
Reference power supply output voltage	V_{REF}	3.54	3.84	4.14	V	$I_{REF}=3\text{mA}$
Reference power supply output current capacity	I_{REF}	3.0	10	—	mA	V_{REF} voltage drop of 0.1V or less
Channel balance	G_{CB}	-2.0	0	2.0	dB	ch1 taken as the standard for measurements.
Volume attenuation (-10 dB)	ATT10	-12.6	-10.6	-8.6	dB	$V_{IN}=0\text{dBV}$, $V_C=0.665XV_{REF}$
VC port discharge current	IVC	—	0.2	0.4	μA	Pin 15 discharge current
TC port discharge current	ITC	—	0.2	0.4	μA	Pin 14th discharge current
BC port discharge current	IBC	—	0.2	0.4	μA	Pin 13th discharge current
SC port discharge current	ISC	—	0.2	0.4	μA	Pin 11th discharge current

* Measurement performed using Matsushita Communication Industrial VP-9690A DIN AUDIO filter (average value wave detection, effective value display).

◎ Not designed for radiation resistance.

● Measurement circuit

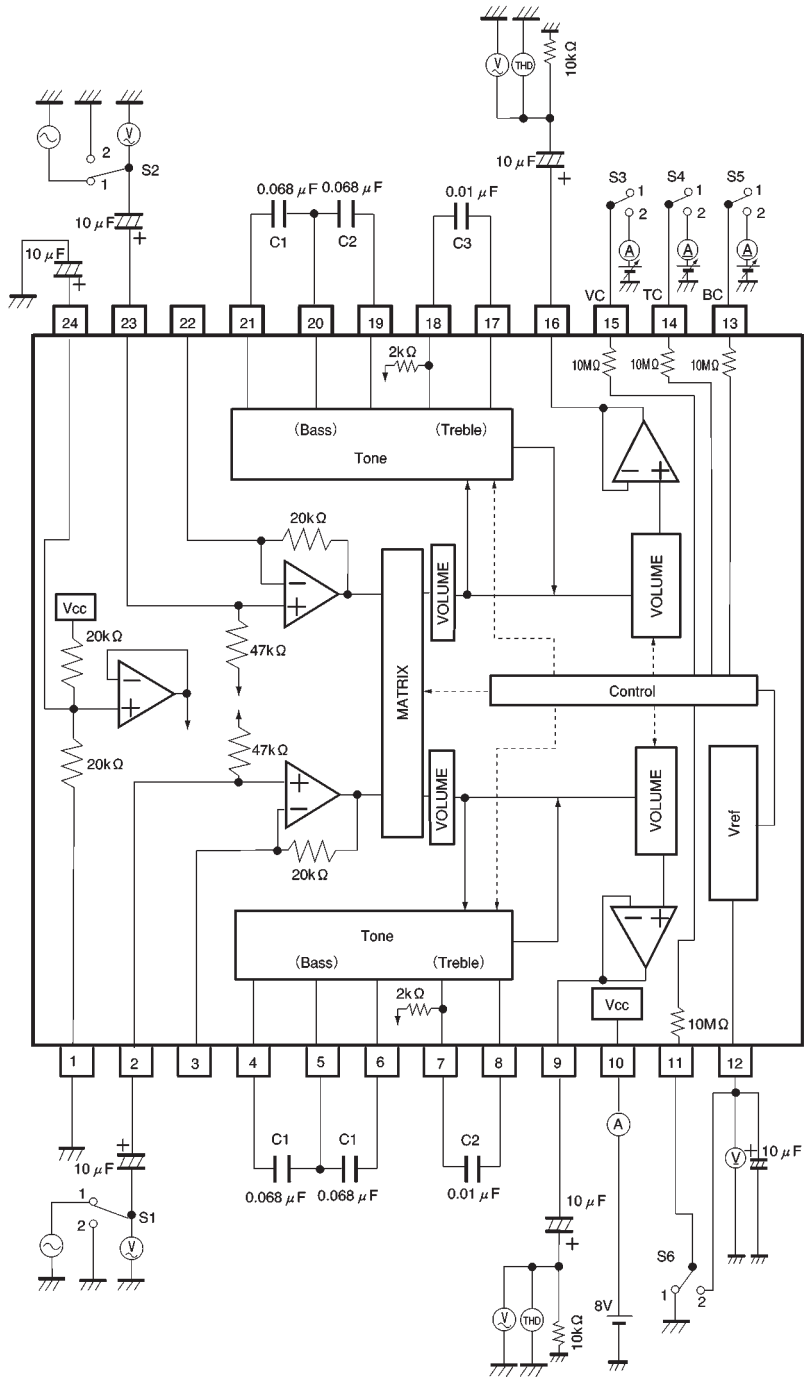

Fig. 1

●Application example

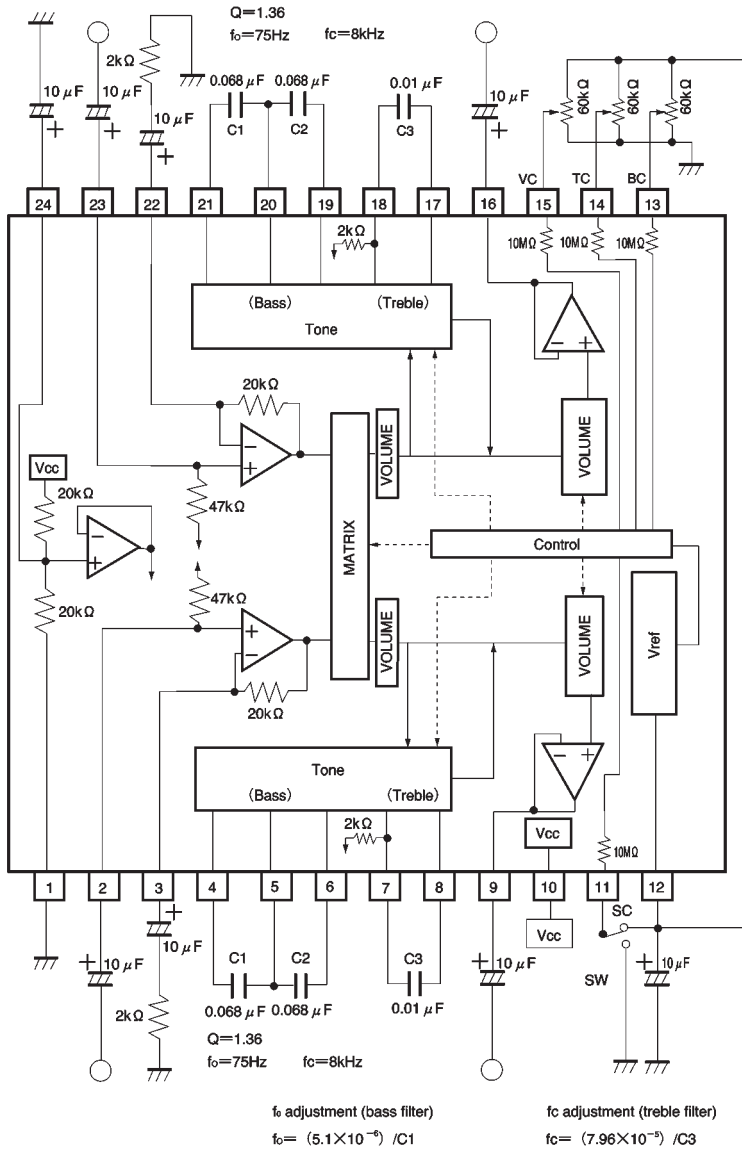

Fig. 2

● Operation notes

(1) Operating power supply voltage range

As long as the operating power supply voltage range and ambient temperature are kept within the specified range, the basic circuits are guaranteed to function, but be sure to check the constants as well as the element settings, voltage settings, and temperature settings. Also, volume curves sometimes depart from target values when there is a combination of low temperature and reduced power.

(2) Primary amp

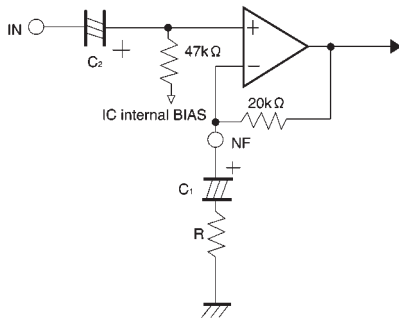

- The input impedance is 47kΩ.
- A buffer if R and C₁ are not present.
- The gain can be set by R and the 20kΩ.

$$G_{VC} = (R + 20k\Omega) / R$$

Note: Set C₂ (input coupling) and C₁ (used to set the gain) depending on the frequency band used.

(3) Bass filter

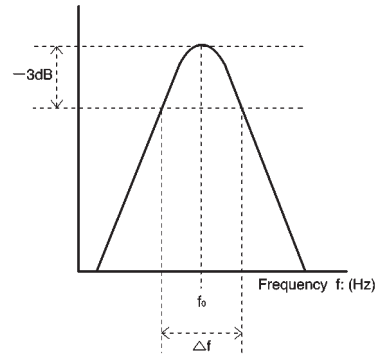
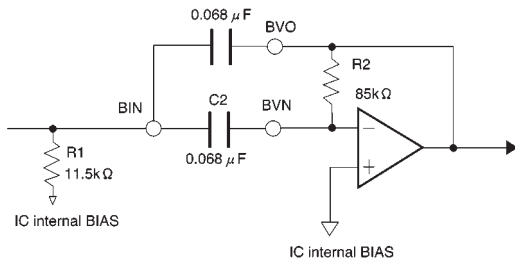

- The BPF is composed of a multifeedback active filter.

f₀ can be varied according to the value of C.

(theoretical equation)

$$f_0 = \frac{1}{2\pi} \times \left(\frac{1}{R_1 R_2 C_1 C_2} \right)^{\frac{1}{2}}$$

$$Q \doteq \left[\left(\frac{R_1}{R_2 C_1 C_2} \right)^{\frac{1}{2}} \times (C_1 + C_2) \right]^{-1}$$

$$G = \frac{R_2}{5k\Omega} \times \left(1 + \frac{C_1}{C_2} \right)^{-1}$$

Note: Filter gain is calculated using the equation on the left. Total output gain is the sum of the gain for each of the internal circuits.

(When R₁ = 11.5kΩ, R₂ = 85kΩ, C₁ = C₂ = C)

$$f_0 = \frac{5.1 \times 10^{-6}}{C} \quad Q = 1.36 \quad G = 8.5$$

(4) Treble filter

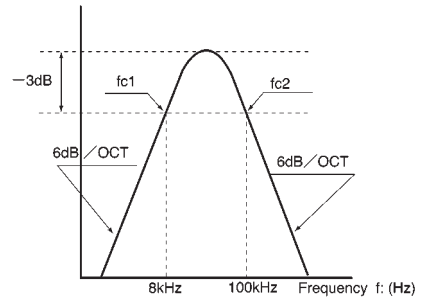
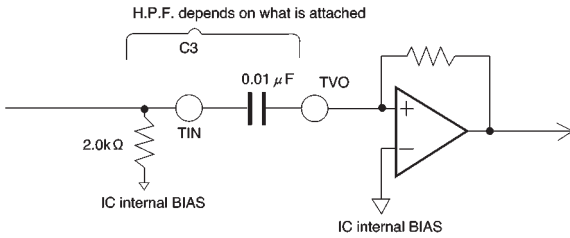

- Cutoff frequency (f_{c1}) for the bypass filter can be changed using the attached C_3 .

$$f_{c1} = \frac{1}{2\pi \times C_3 \times 2k\Omega}$$

The f_{c1} for the recommended constant is approximately 8 kHz.

- f_{c2} is determined by the band of the built-in amp. f_{c2} is approximately 100 kHz.

Tone control is designed to yield a variation of $\pm 15\text{dB}$ (Typ.) when the frequency to be boosted or cut is at the peak or bottom of the filter frequency characteristic, so please take the frequency characteristic into consideration in designing the filter.

(5) Signal level setting

The following figure represents the standard setting for the BH3852FS / BH3852S.

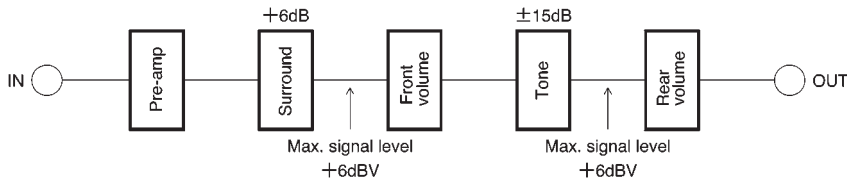

★As indicated above, if the front volume and rear volume input level are set so as not to exceed +6dBV (2Vrms), the pre-amp gain setting can be used to improve the S/N ratio.

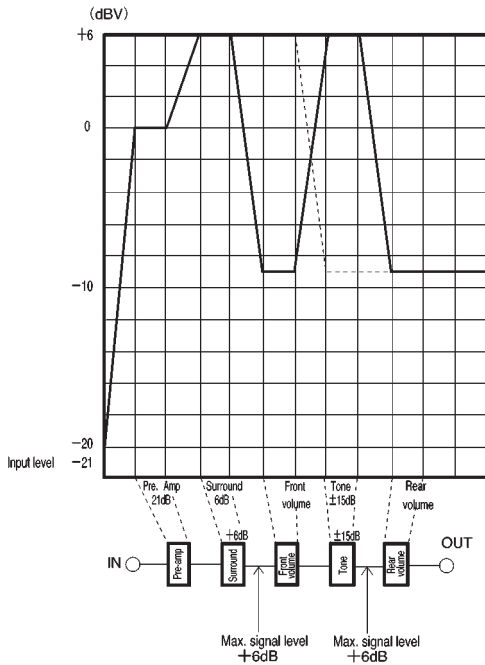

The figure on the left is a level diagram.
 Solid line: Input level during tone boost
 Dotted line: Input level during tone cut

(6) Matrix surround

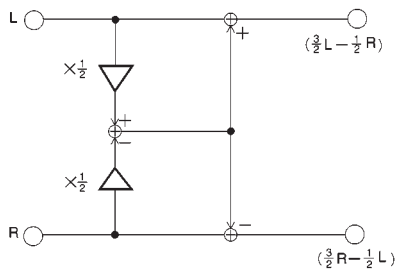

© The structure of the matrix surround is as shown in the figure above. Use the equations shown in the figure to calculate gain.

In-phase gain	0dB
Negative-phase gain	3.5dB

(Negative-phase gain only occurs when input is carried out at a single channel.)

(7) DC control

It is recommended that DC control of the VC, TC, BC, and SC pins be performed by voltage delivered in variable volume from the V_{ref} pin (12th pin). When using variable volume, take the discharge current of each pin into account in determining its settings.

Note: The voltage range for DC control is 0 (V) to V_{ref} (V). Be sure not to apply voltage greater than V_{ref} (V) to any pin.

(8) GND

If several capacitors with good high-frequency characteristics are connected in parallel to the 12th-pin capacitor, the characteristics will be improved with respect to static electricity noise. (Recommended : ceramic capacitors of 0.001 μ F to 0.1 μ F)

●Electrical characteristic curves

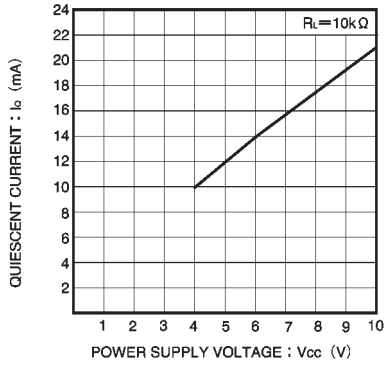

Fig. 3 Quiescent curve vs. power supply voltage

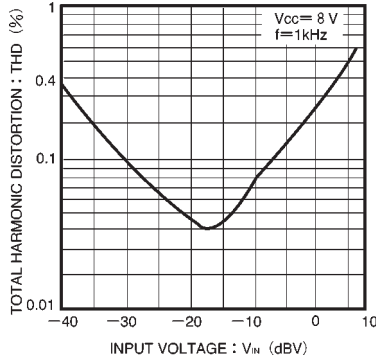

Fig. 4 Harmonic distortion vs. input voltage

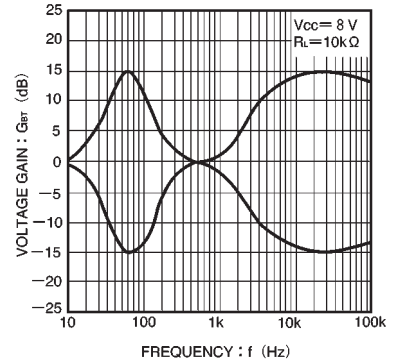

Fig. 5 Output gain vs. frequency

●External dimensions (Units: mm)

