

# MN863831EFS

## 320-Output STN Segment Driver

### ■ Overview

The MN863831EFS is a 320-output segment driver IC for dot matrix STN LCD panels. It latches 4-bit or 8-bit parallel data transferred from an LCD controller and generates the LCD drive signals.

In combination with an LCD common driver IC, MN86372 series, this IC is optimal for implementing low-power LCD modules. Since this IC also provides an LCD drive voltage compensation function, it can implement high-quality LCD display modules with minimal crosstalk. It supports both color and monochrome displays.

### ■ Features

- Supports LCD drive voltages up to 6.0 V.
- Provides 320 LCD drive outputs.
- Provides an LCD drive voltage compensation function to implement high-quality LCD display modules with minimal crosstalk.
- Inverts the LCD drive voltage by signal alternation.
- Provides 5 LCD drive voltage input pins: VHC, VH, VM, VL, and VLC
- Built-in voltage conversion block (level shifter) allows interfacing with LCD controllers with supply voltages in the range from 2.5 V to 5.5 V.
- Built-in bidirectional shift register allows arbitrary direction of the output data transfer and allows easy mounting in large-screen applications.
- Supports multistage cascade connection to drive high-resolution LCD panels.
- Supports both 4-bit and 8-bit parallel input mode.
- The 4-bit and 8-bit parallel input modes allow data rates 1/4 or 1/8 of those required with conventional serial transfer devices for lower power consumption.
- Provides a power saving function, in which all but one driver are set to standby mode and disable to input display data, for even lower power consumption in LCD modules with multistage cascade connection.

### ■ Applications

- Word processors, PDAs, and other portable information terminals

■ Block Diagram

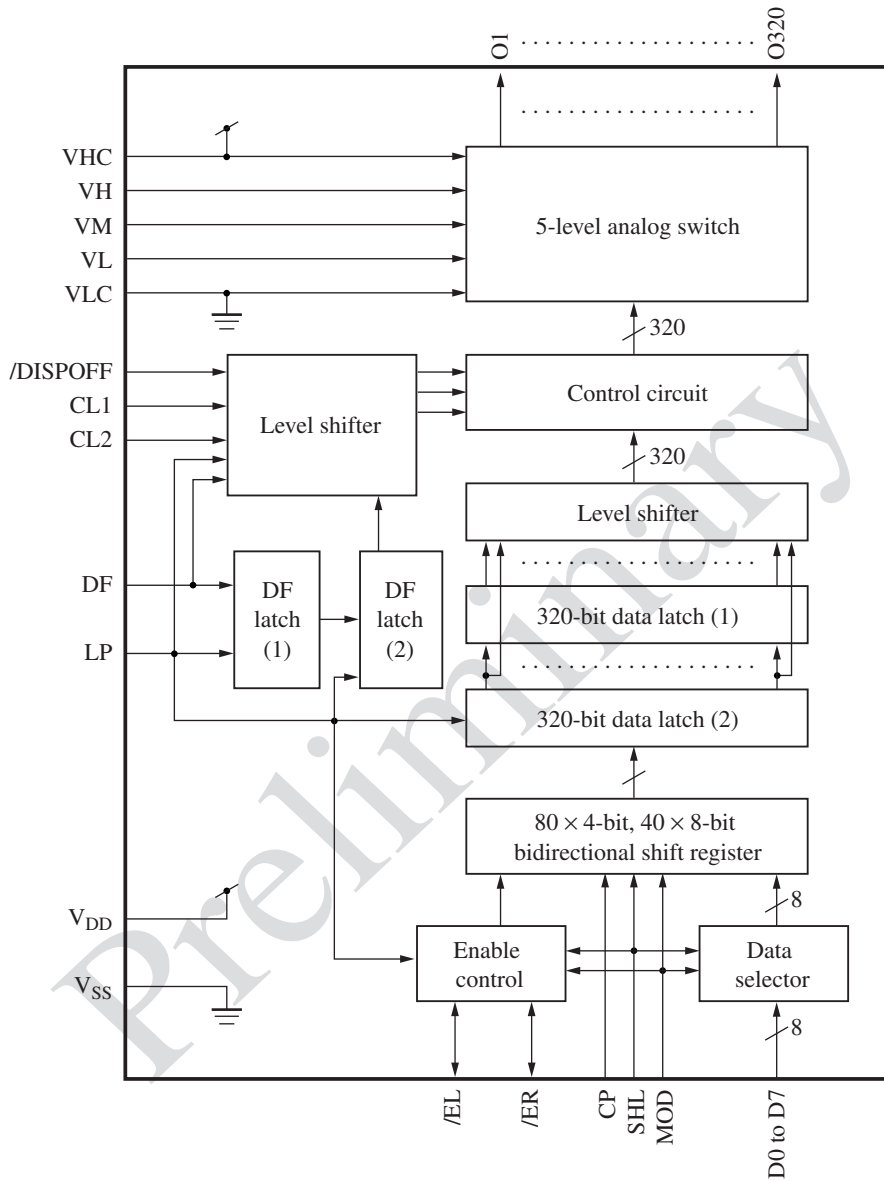

■ Pin Arrangement

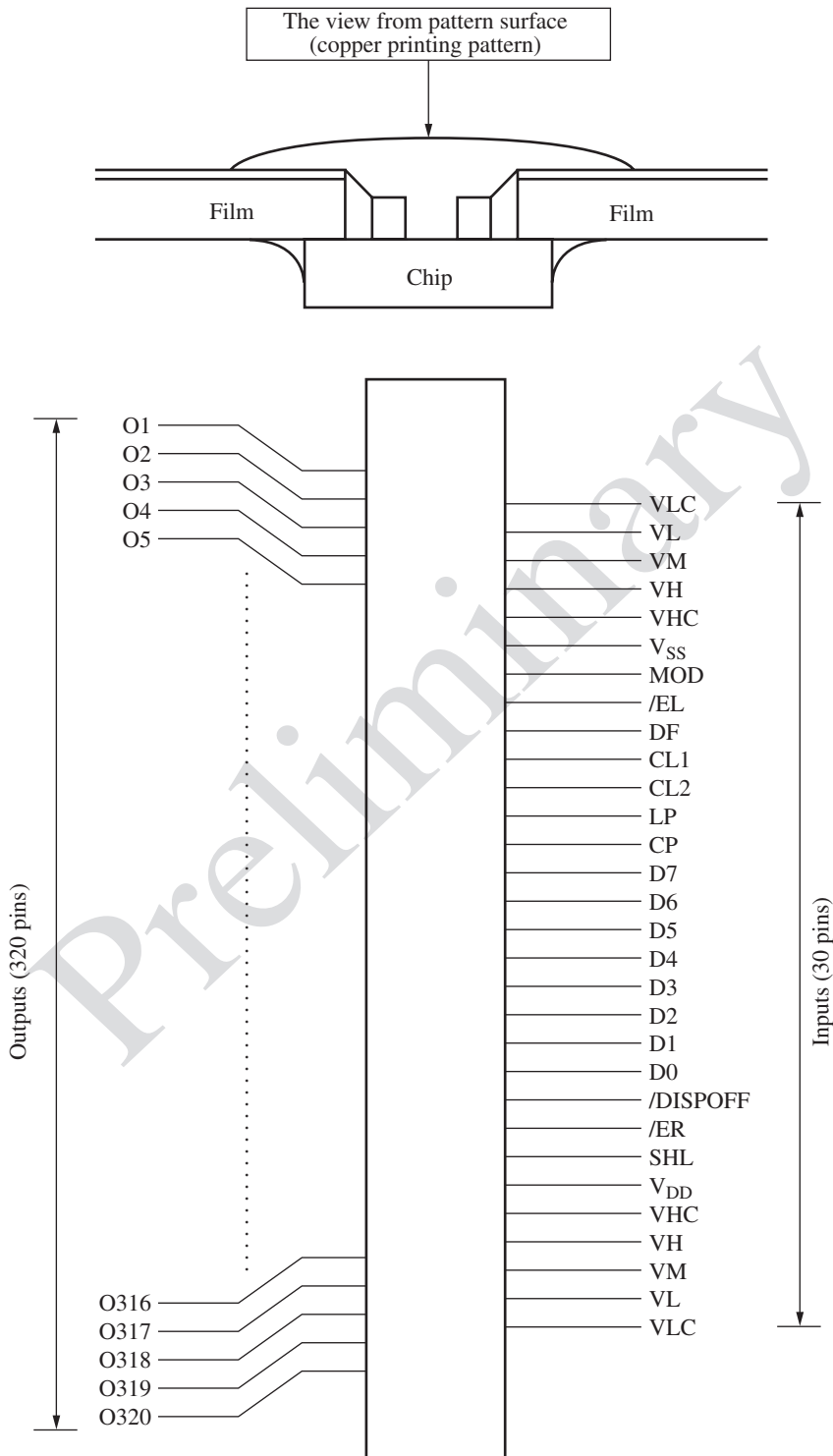

## ■ Pin Descriptions

Pin No.	I/O	Function	Description						
D0 to D7	I	Display data inputs (8 bits)	Parallel input of display data in 4-bit or 8-bit units. <ul style="list-style-type: none"> <li>In 4-bit parallel input mode, the 4 pins D0 to D3 are used for data input. The 4 pins D0 to D7 should be tied to <math>V_{DD}</math> or <math>V_{SS}</math>.</li> <li>In 8-bit parallel input mode, the 8 pins D0 to D7 are used for data input.</li> </ul>						
O1 to O320	O	LCD drive outputs	These pins output the LCD drive voltages.						
SHL	I	Shift direction selection	Switches the shift register data shift direction, and the /ER and /EL pin I/O mode.						
CP	I	Shift clock input	The shift register transfer clock input. The shift register operates on the falling edge of this signal.						
LP	I	Latch signal input	The DF signal and the shift register data are latched on the falling edge of this signal, and the latched data is output.						
/DISPOFF	I	Display off input	The LCD drive outputs output the VM level regardless of the data while this pin is low.						
CL1	I	LCD compensation voltage (VHC and VLC) control	Controls the period for the LCD compensation voltage (VHC and VLC) output to the LCD drive output pins according to the display data.						
CL2	I	LCD compensation voltage (VM) control	Controls the period for the LCD compensation voltage (VM) output to the LCD drive output pins according to the display data.						
DF	I	Alternation signal input	Performs signal alternation for the LCD drive voltage.						
$V_{DD}$	Power supply	Logic system power supply	Power supply used for the logic circuits						
$V_{SS}$	Power supply	GND	GND						
VH (2 pins)	Power supply	Drive power supply	LCD drive power supply						
VL (2 pins)	Power supply	Drive power supply	LCD drive power supply						
VM (2 pins)	Power supply	Drive power supply	LCD drive power supply, (LCD compensation power supply)						
VHC (2 pins)	Power supply	Drive power supply	LCD drive power supply, (LCD compensation power supply) Used as the power supply for the LCD drive circuit.						
VLC (2 pins)	Power supply	Drive power supply	LCD drive power supply, (LCD compensation power supply) Connected internally to the $V_{SS}$ pin.						
/EL	I/O	Enable signal input and output	Data input/output for the chip enable signal						
/ER	I/O	Enable signal input and output	Data input/output for the chip enable signal						
MOD	I	Mode selection	<table border="1"> <tr> <td>MOD</td> <td></td> </tr> <tr> <td>Low</td> <td>4-bit parallel input</td> </tr> <tr> <td>High</td> <td>8-bit parallel input</td> </tr> </table>	MOD		Low	4-bit parallel input	High	8-bit parallel input
MOD									
Low	4-bit parallel input								
High	8-bit parallel input								

## ■ Function Descriptions

### 1. Control circuit for bidirectional shift register

This IC includes two circuits, an enable control circuit and a data selector, that control the built-in bidirectional shift register.

#### 1.1 Enable control circuit

This circuit consists of a base-80 counter circuit (for 4-bit parallel input mode), a base-40 counter circuit (for 8-bit parallel input mode), and a control circuit for the chip enable I/O circuit.

This counter counts clock pulses and outputs a carry on the falling edge of the 80th clock cycle (in 4-bit parallel input mode) or the 40th clock cycle (in 8-bit parallel input mode). This corresponds to the completion of the shift register data shift operation. This carry stops the data shift clock internally to the IC, and places the counter and the shift register in the stopped state. When LP signal goes high, the base-80 and base-40 counters are reset and set to the counter wait state (standby state).

The standby state is not cleared until the chip enable I/O signal (/EL and /ER) that corresponds to shift direction goes low. When that chip enable signal goes low, the data shift clock and counter start operating again.

When this IC is connected in the serial cascade form, the counter carry signal is used as the chip enable signal for the driver IC in the next stage. The result of this operation is that at the completion of each 80 clock cycles (in 4-bit parallel input mode) or 40 clock cycles (in 8-bit parallel input mode), the next driver IC in sequence goes to the active state and the total power consumption of the whole LCD panel is reduced.

#### 1.2 Data selector circuit

This circuit determines, based on the state of the SHL pin, the data shift direction of the internal shift register and the I/O mode of the chip enable I/O pin as shown in tables 1-a and 1-b.

### 2. $80 \times 4$ -bit (4-bit parallel input mode)/ $40 \times 8$ -bit (8-bit parallel input mode) bidirectional shift register

The IC internal 4-bit parallel 80-stage and 8-bit parallel 40-stage bidirectional shift registers operate on the falling edge of the clock pulse.

In 4-bit parallel input mode, since the input data is divided into 4-bit parallel units, the shifting of the 320 output units of data requires 80 clock cycles. (See Timing Charts 1 and 3.)

In 8-bit parallel input mode, since the input data is divided into 8-bit parallel units, the shifting of the 320 output units of data requires 40 clock cycles. (See Timing Charts 2 and 4.)

The shift direction is selected by the SHL pin as shown in tables 1-a and 1-b.

### 3. 320-bit data latch (2)

The 320-bit data latch (2) holds the 320 bits of data acquired by the shift register for a single horizontal scan period (1H).

Data is latched on the falling edge of the LP signal, which is the start pulse for the horizontal scan period, held for 1H, and the next data is latched on the next falling edge on the LP signal.

Timing Chart 3 shows the shift register and latch operation for the first stage segment driver when multiple driver ICs are connected in series and operated in 4-bit parallel mode.

Also, Timing Chart 4 shows the shift register and latch operation for the first stage segment driver when multiple driver ICs are connected in series and operated in 8-bit parallel mode.

## ■ Function Descriptions (continued)

### 4. Level shifters

The level shifters convert levels from the logic circuit signal levels ( $V_{DD}$  = high,  $V_{SS}$  = low) to the signal levels ( $V_{HC}$  = high,  $V_{LC} = V_{SS}$  = low) used by the LCD drive circuits, such as the analog switches. The IC includes two types of level shifters, one is for 320 bits display data and the other is for control signals.

### 5. 320-bit data latch (1)

The 320-bit data latch (1) holds the 320 bits of display data acquired by the 320-bit data latch (2) for an additional 1H. Thus the 320-bit data latch (1) holds the data for the previous line from the display data currently being scanned.

Data is latched on the falling edge of the LP signal, held for 1H, and the next data is latched on the next falling edge on the LP signal.

### 6. 5-level analog switch

The 5-level analog switch is controlled by the control circuit and selects one of the 5 drive voltages ( $V_{HC}$ ,  $V_H$ ,  $V_M$ ,  $V_L$ , and  $V_{LC}$ ), and outputs the selected levels to the 320 LCD drive output pins.

### 7. DF latch (1)

The DF latch (1) holds the DF data for a single horizontal scan period (1H).

Data is latched on the rising edge of the LP signal, which is the start pulse for the horizontal scan period, held for 1H, and the next data is latched on the next rising edge on the LP signal.

### 8. DF latch (2)

The DF latch (2) latches the data acquired by the DF latch (1) on the falling edge of the LP signal, holds that data for 1H, and latches the next data on the next falling edge of the LP signal.

(Timing Charts 3 and 4 show this latch operation.)

### 9. Control circuit

The voltage selected by the 5-level analog switch is determined by the 320-bit data latch (1), the 320-bit data latch (2), the /DISPOFF signal, the CL1 signal, the CL2- $\overline{LP}$  signal, the DF input, and DF latch (2).

When the /DISPOFF signal is low, the  $V_M$  level of the LCD drive voltage is selected, regardless of the values of the data latches (1) and (2) outputs, the DF input, the DF latch (2) output, and the high/low state of the CL1 and CL2- $\overline{LP}$  signals. When the /DISPOFF signal is low, the  $V_M$  level is output from the common driver, and the voltage applied to all of the dots becomes 0 V, since the same voltage is applied. This results in a completely blank display.

When either the CL1 or CL2- $\overline{LP}$  signal is high, the IC switches the LCD drive voltage and the LCD compensation voltage by comparing the data latch (1) and (2) outputs with the DF input and the DF latch (2) output.

Table 2 lists the LCD drive output pin output voltage levels according to the data latch (1) output ( $Q_{n-1}$ ), the data latch (2) output ( $Q_n$ ), the CL1 and CL2- $\overline{LP}$  signals, the DF input, the DF latch (2) output ( $DF_{n-1}$ ), and the /DISPOFF signal.

Figure 1 presents examples of the LCD drive output pin waveform as driven according to table 2, which appears later. Two examples are presented, one with the DF pin held high, and the other with an LCD alternation signal input to the DF pin.

■ Function Descriptions (continued)

Table 1-a. Data shift control

In 4-bit parallel input mode (MOD = low)

SHL	/ER	/EL	Shift clock								
			1	2	...	n	...	79	80		
Low	Input	Output	D3	→	O320	O316	...	O4(80-n)+4	...	O8	O4
			D2	→	O319	O315	...	O4(80-n)+3	...	O7	O3
			D1	→	O318	O314	...	O4(80-n)+2	...	O6	O2
			D0	→	O317	O313	...	O4(80-n)+1	...	O5	O1
High	Output	Input	D3	→	O1	O5	...	O4n-3	...	O313	O317
			D2	→	O2	O6	...	O4n-2	...	O314	O318
			D1	→	O3	O7	...	O4n-1	...	O315	O319
			D0	→	O4	O8	...	O4n	...	O316	O320

Table 1-b. Data shift control

In 8-bit parallel input mode (MOD = high)

SHL	/ER	/EL	Shift clock								
			1	2	...	n	...	39	40		
Low	Input	Output	D7	→	O240	O232	...	O8(40-n)+8	...	O16	O8
			D6	→	O239	O231	...	O8(40-n)+7	...	O15	O7
			D5	→	O238	O230	...	O8(40-n)+6	...	O14	O6
			D4	→	O237	O229	...	O8(40-n)+5	...	O13	O5
			D3	→	O236	O228	...	O8(40-n)+4	...	O12	O4
			D2	→	O235	O227	...	O8(40-n)+3	...	O11	O3
			D1	→	O234	O226	...	O8(40-n)+2	...	O10	O2
			D0	→	O233	O225	...	O8(40-n)+1	...	O9	O1
High	Output	Input	D7	→	O1	O9	...	O8n-7	...	O305	O313
			D6	→	O2	O10	...	O8n-6	...	O306	O314
			D5	→	O3	O11	...	O8n-5	...	O307	O315
			D4	→	O4	O12	...	O8n-4	...	O308	O316
			D3	→	O5	O13	...	O8n-3	...	O309	O317
			D2	→	O6	O14	...	O8n-2	...	O310	O318
			D1	→	O7	O15	...	O8n-1	...	O311	O319
			D0	→	O8	O16	...	O8n	...	O312	O320

■ Function Descriptions (continued)

Table 2. LCD drive output pin output voltage

/DISPOFF	CL1	CL2 · $\overline{LP}$	DF latch (2) output DF <sub>n</sub> -1	DF input	Data latch (1) output Q <sub>n</sub> -1	Data latch (2) output Q <sub>n</sub>	LCD drive output O1 to O320				
High	High	Low	High	High	High	High	VL				
						Low	VHC				
						Low	VLC				
					Low	VH					
					Low	High	VHC				
						Low	VL				
				Low		VH					
				Low	High	High	High	High	High	VLC	
									Low	VH	
			Low						VL		
			Low		High		High	High	High	VH	
									Low	VLC	
									Low	VH	
			Low		High	High	High	High	High	VLC	
									Low	VH	
									Low	VL	
				Low	High		High	High	High	VH	
									Low	VLC	
	Low	VH									
	Low	High		High	High	High	High	High	VL		
								Low	VM		
								Low	VM		
			Low				VH				
			Low				High	High	High	High	VM
										Low	VL
						Low				VH	
			Low			High	High	High	High	VM	
									Low	VL	
					Low				VM		
			Low		High	High	High	High	High	VM	
									Low	VH	
									Low	VL	
					Low		High	High	High	High	VH
										Low	VM
										Low	VL
					Low	High	High	High	High	High	VM
Low										VH	
Low	VL										
Low	High	High	High	High		VH					
				Low		VM					
				Low		VL					
Low	Low	Low	*	High		*	High	VL			
							Low	VH			
			Low	High		High	High	High	VH	VH	
					Low					VL	
Low	*	*	*	*	*	*	VM				

Note) 1. \*: Don't care

2. The timing charts for the IC blocks are presented on the following pages.
3. The IC is specified to operate as follows: when the DF input is high, the output is inverted with respect to the actual input data.
4. To provide correct display, either the input data must be inverted, or an input to the DF pin that is inverted with respect to that of the common driver must be provided.



■ Function Descriptions (continued)

Figure 1. LCD drive output waveform examples

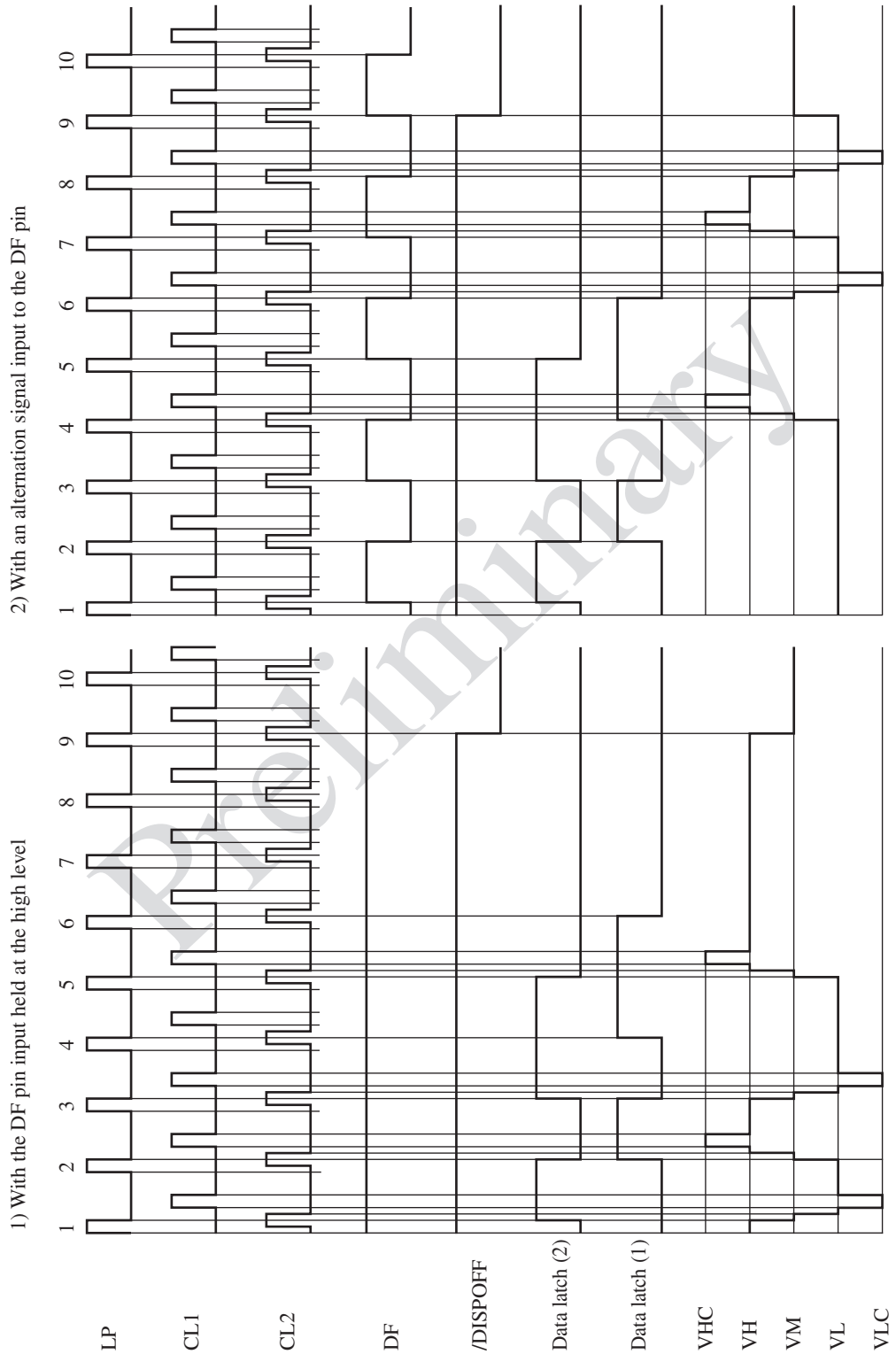

■ Timing Charts

1. Counter and chip enable pins (4-bit parallel input mode)

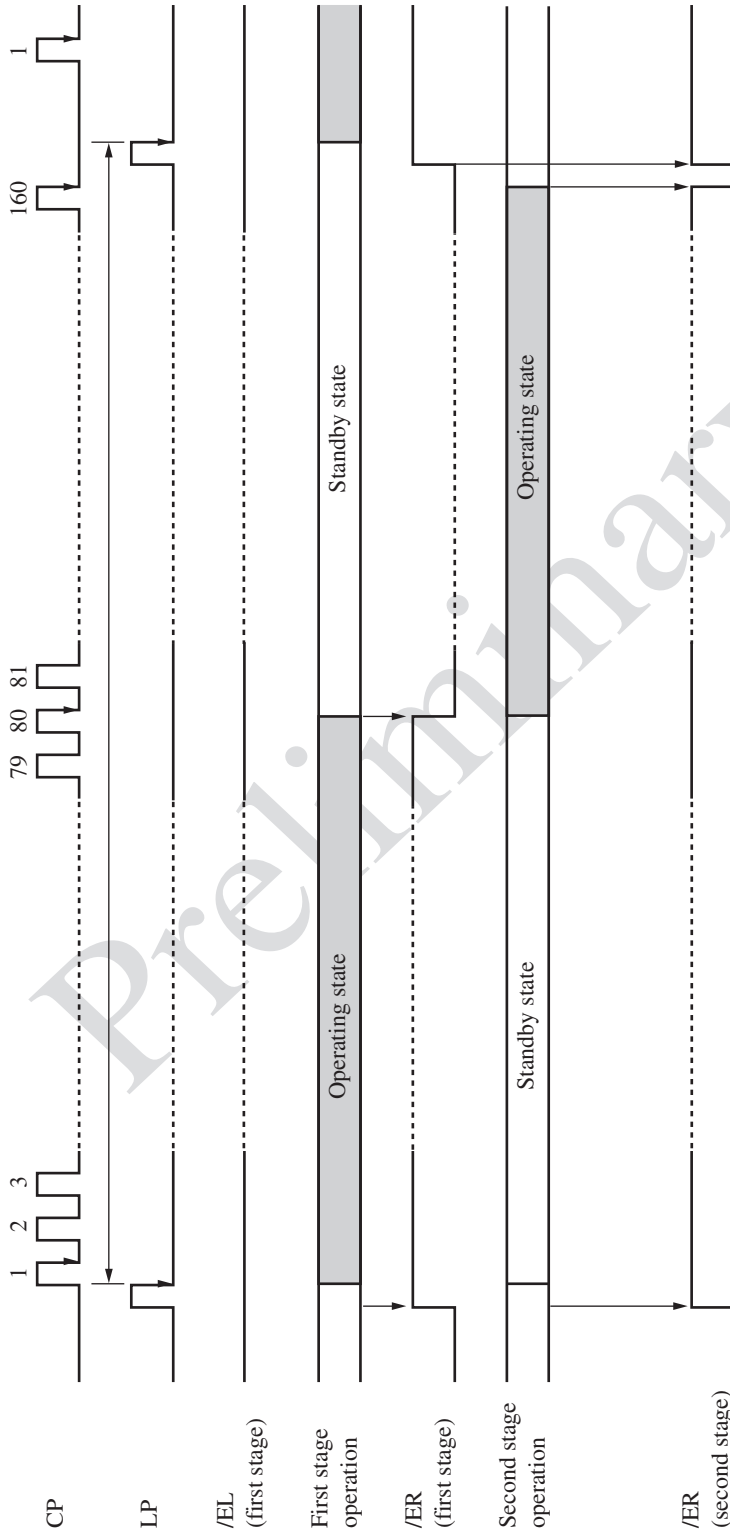

Note) 1. When two ICs are connected in cascade (SVGA color display panel)

2.  $f_{LP} = f_{CP} / 160$

3. SHL = high

Note that when SHL is low, the only difference is that the /ER and /EL in input and output will be reversed. In the above timing chart, /EL becomes /ER and /ER becomes /EL.

4. MOD = low

■ Timing Charts (continued)

2. Counter and chip enable pins (8-bit parallel input mode)

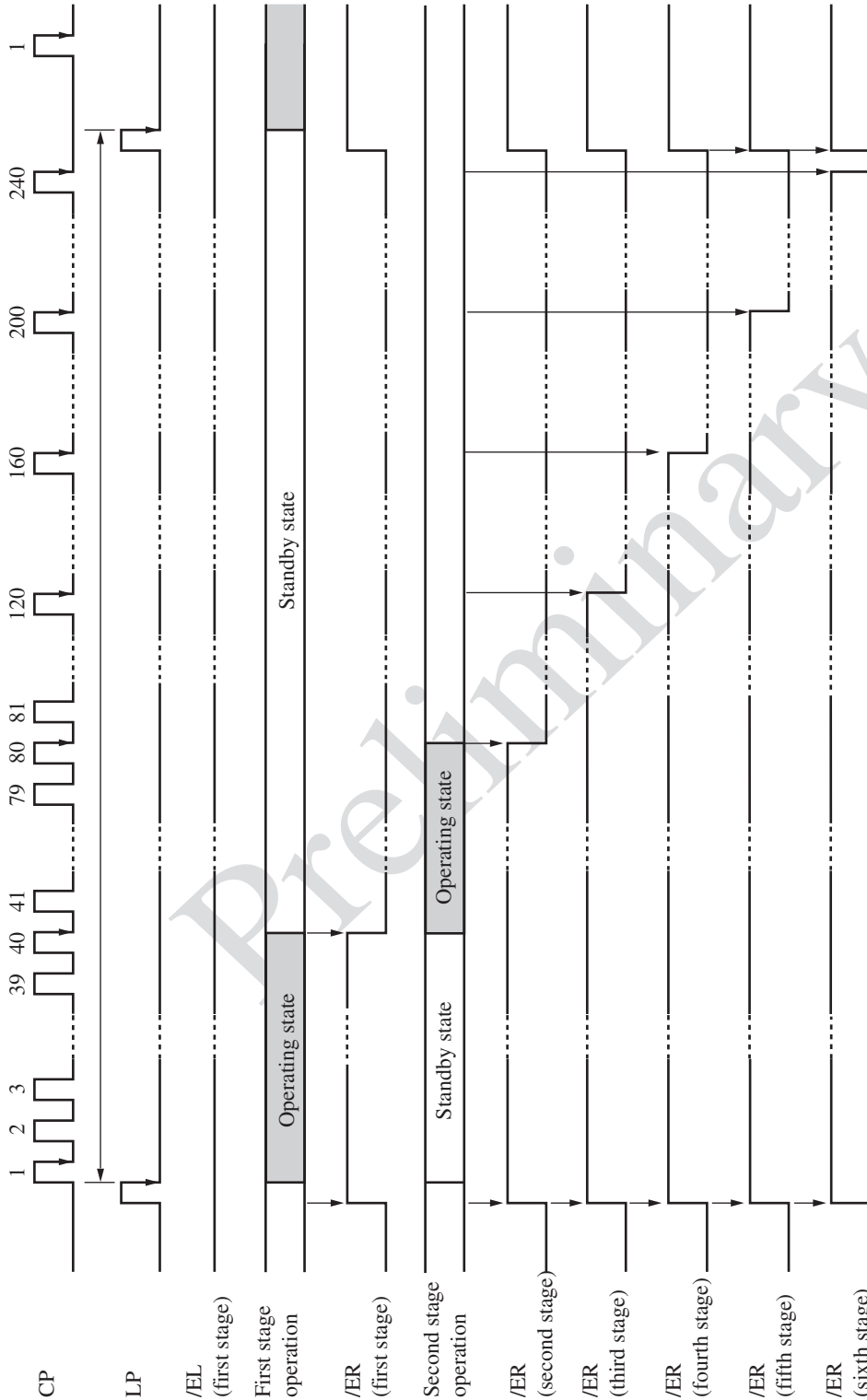

Note) 1. When six ICs are connected in cascade (XGA color display panel)

2.  $f_{LP} = f_{CP}/240$

3. SHL = high

Note that when SHL is low, the only difference is that the /ER and /EL in input and output will be reversed. In the above timing chart, /EL becomes /ER and /ER becomes /EL.

4. MOD = high

■ Timing Charts (continued)

3. Shift register and latch operation (SVGA LCD panel)

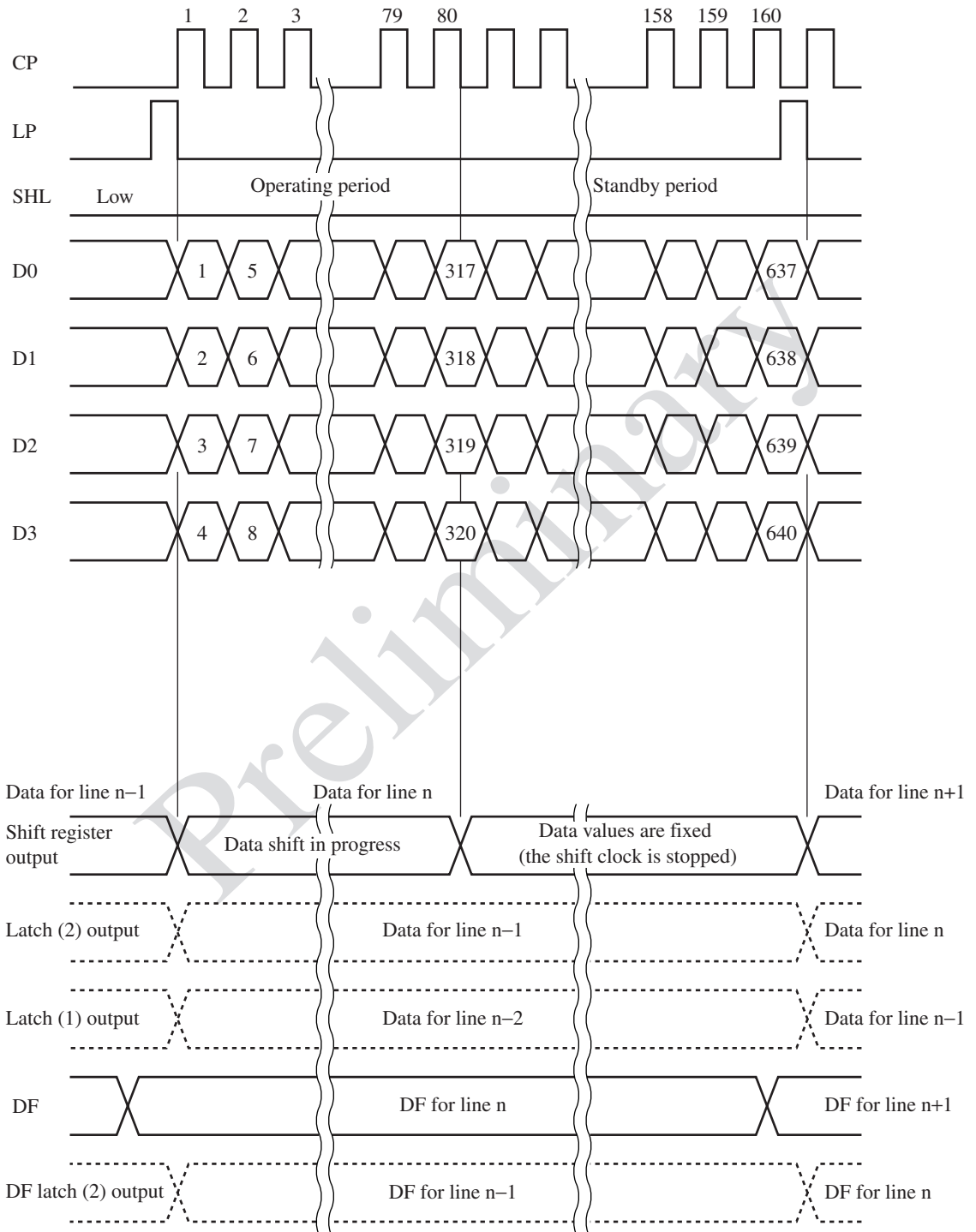

Note)  $f_{LP} = f_{CP} / 160$

■ Timing Charts (continued)

4. Shift register and latch operation (XGA LCD panel)

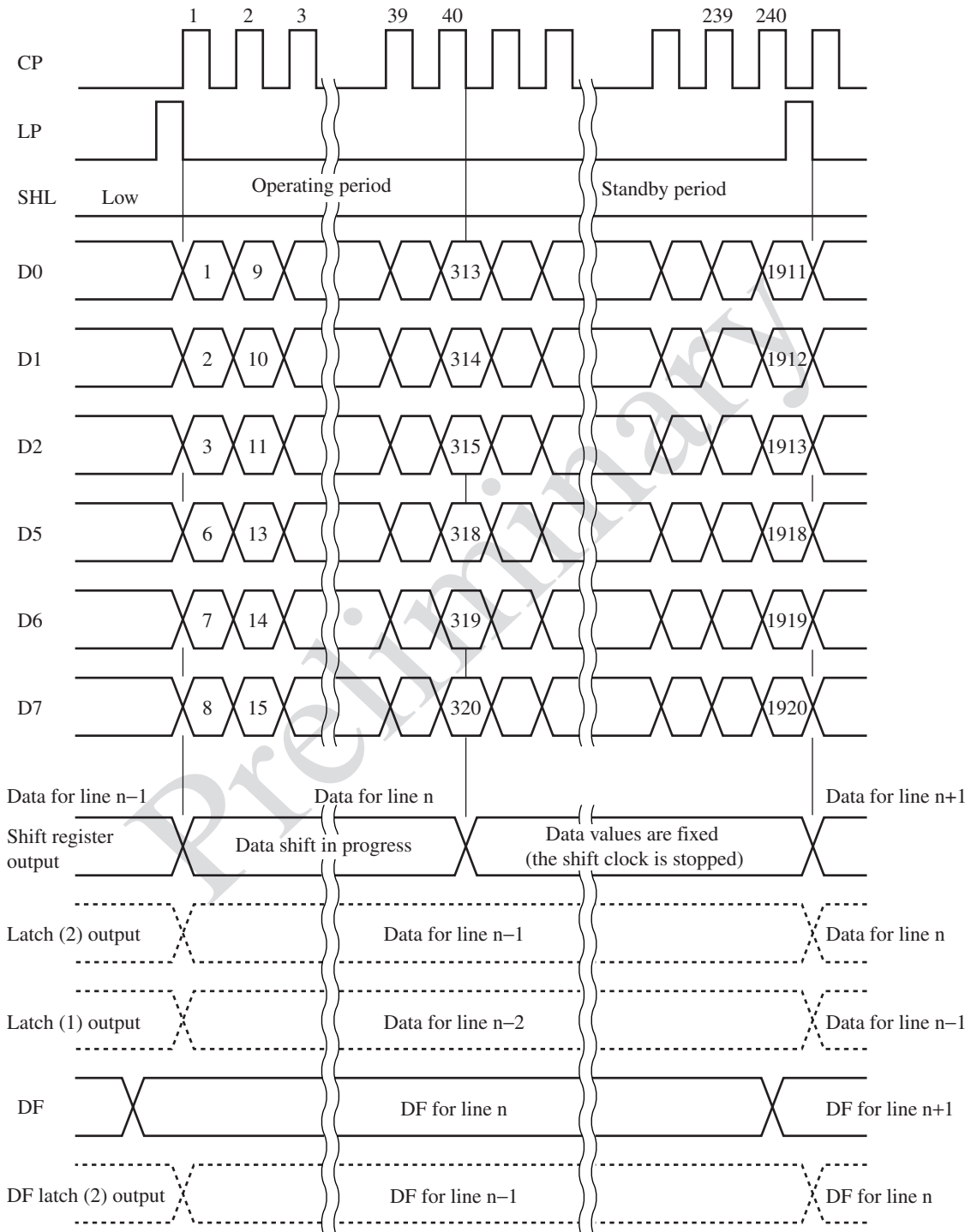

Note)  $f_{LP} = f_{CP} / 240$

■ Timing Charts (continued)

5. Segment driver LCD output waveforms

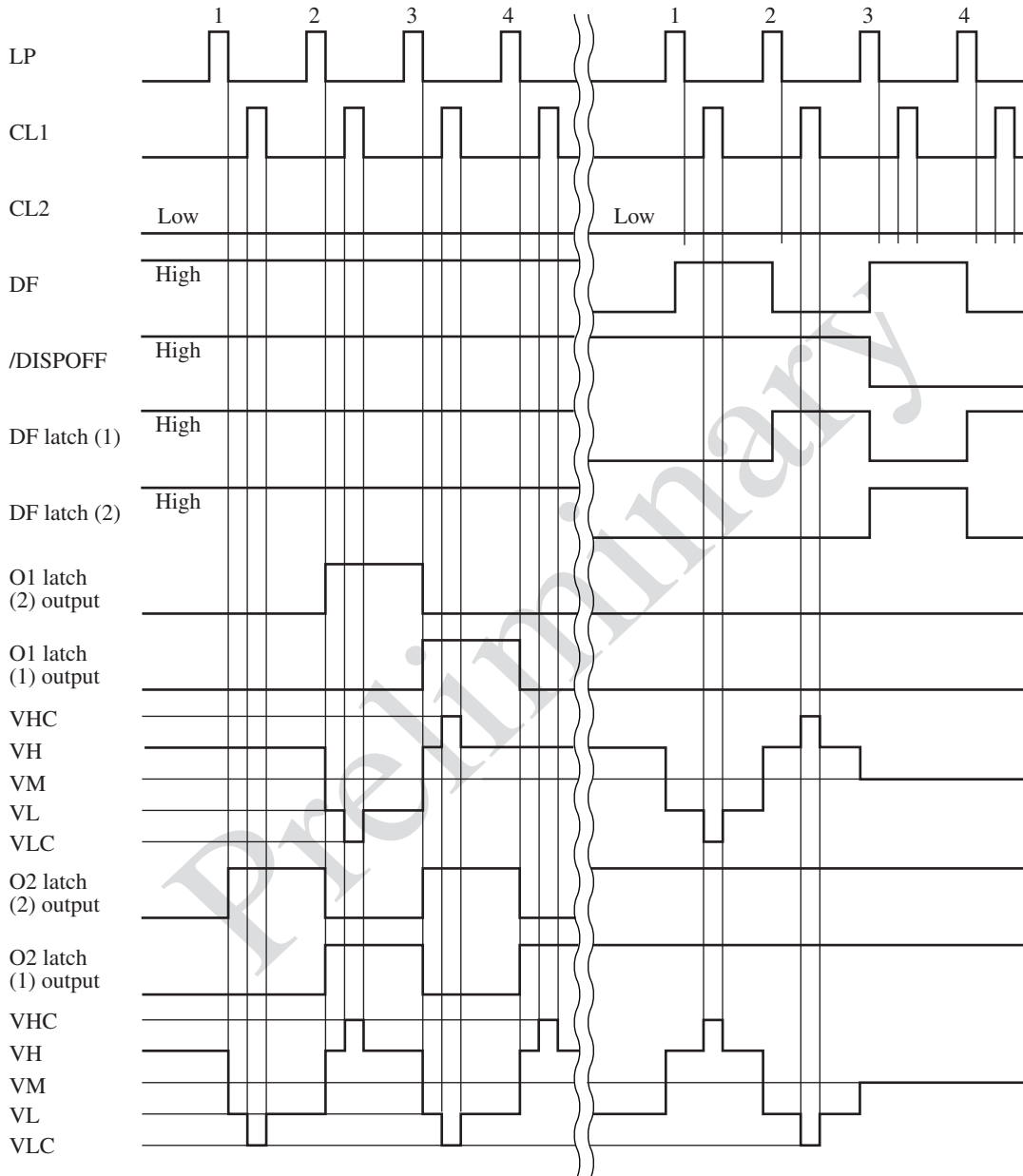

Note) The figure above shows the correspondence between the latch (1) and latch (2) data (DF latch (1) and DF latch (2)); the O1 and O2 drive voltages.

■ Timing Charts (continued)

6. Segment and common driver LCD output waveforms (when /DISPOFF is high)

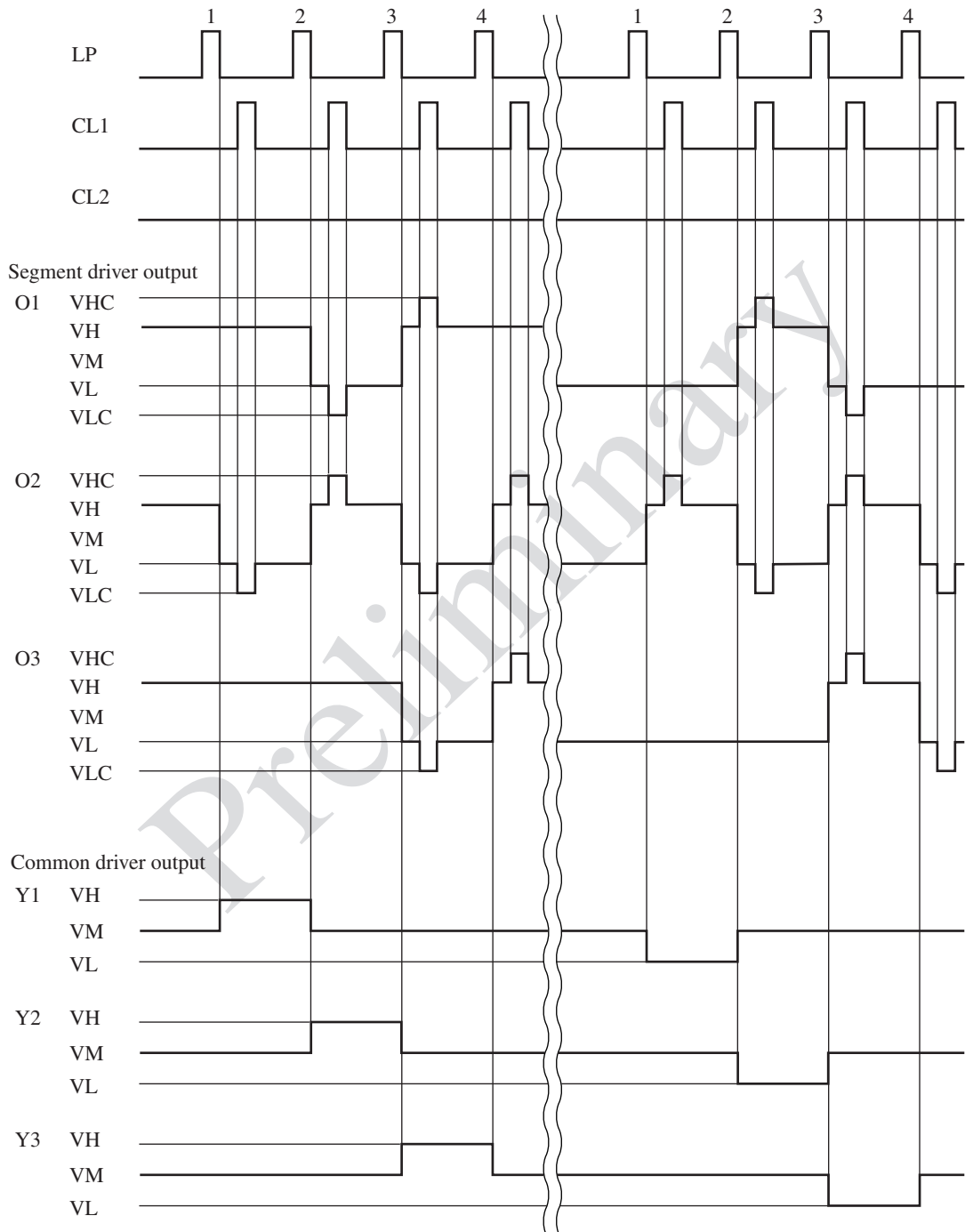

■ Timing Charts (continued)

7. LCD display and LCD applied voltage waveforms (when /DISPOFF is high)

When the drive outputs shown in section 6 are applied, if the display is normally white, the display will be shown in the right figure.

If the display is normally black, then the display will be set up for black/white reversed display. The waveforms of the voltages applied to (1,1) and (2,3) dots in the right figure are shown below.

Note that the applied voltages are referenced to the common side drive voltage  $V_M$ , and therefore displayed as  $V_{COM}-V_{SEG}$ .

$$V_{LCD} = V_{COM} - V_{SEG}$$

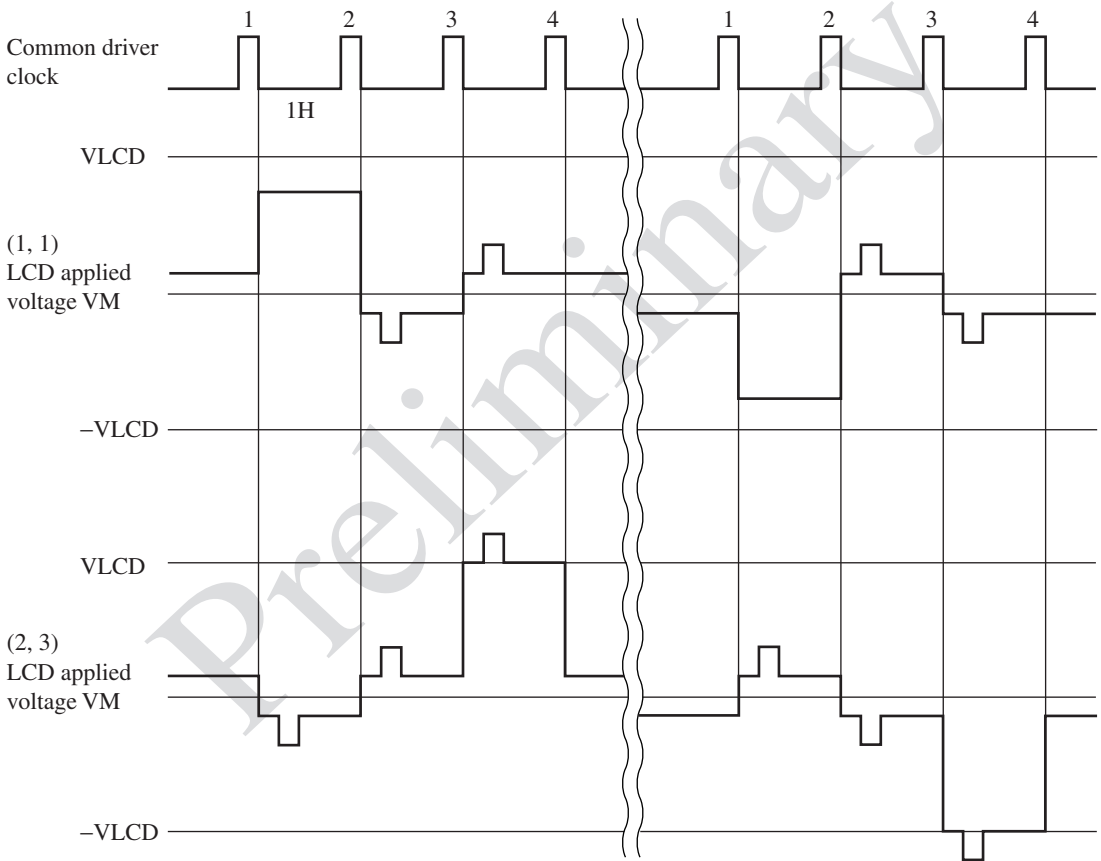
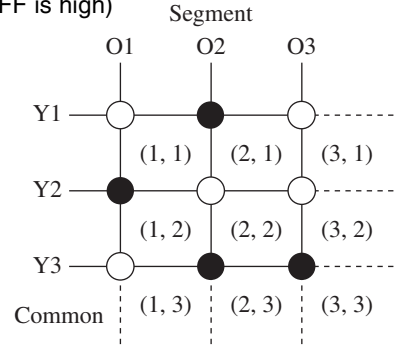

- Note) 1. When the LCD voltage applied to a dot is  $\pm VLCD$ , it will be displayed as black in normally white mode and as white in normally black mode.
2. Since the drive waveform is dilled at the segment drive waveform transition and the actual voltage drops, this IC applies the compensation voltage at the drive waveform transition to compensate the actual voltage.



## ■ LCD Drive Voltage Names and Relationships (Reference)

The figure presents the LCD drive voltage provided by this IC and the MN8637 series common drivers, and the relationships between those voltages.

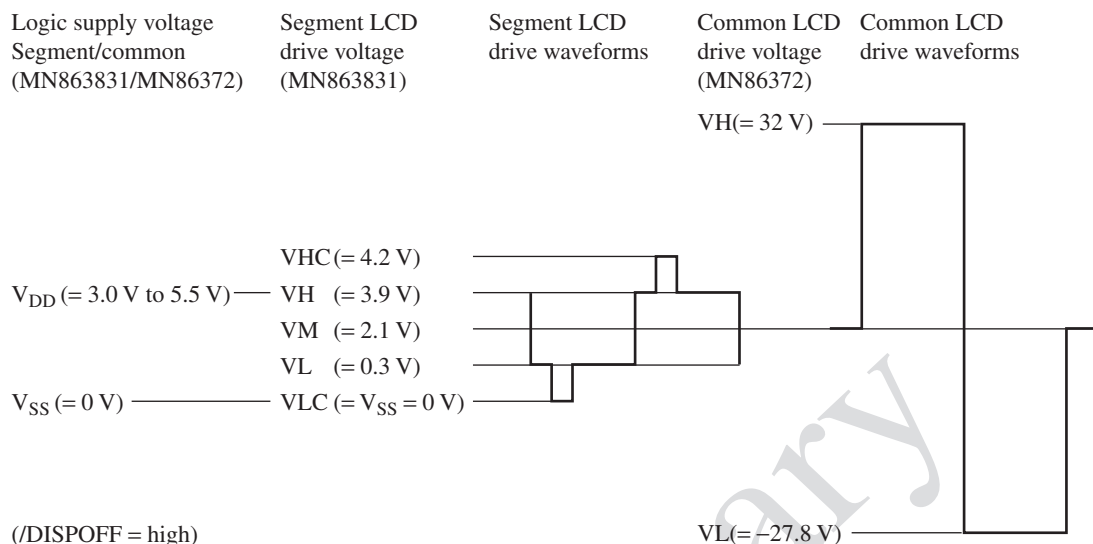

## ■ Electrical Characteristics

### 1. Absolute Maximum Ratings at $V_{SS} = 0\text{ V}$ , $T_a = 25^\circ\text{C}$

Parameter	Symbol	Rating	Unit
Supply voltage 1	$V_{DD}$	- 0.3 to +7.0	V
Supply voltage 2	VHC	- 0.3 to +7.0	V
Drive voltage	$V_n$	- 0.3 to VHC+0.3	V
Input voltage	VIN	- 0.3 to $V_{DD}+0.3$	V
Operating temperature	$T_{opr}$	-20 to +75	$^\circ\text{C}$
Storage temperature	$T_{stg}$	-40 to +125	$^\circ\text{C}$

Note) 1. The absolute maximum ratings are limiting values for applied stresses below which the chip will not be destroyed. Operation is not guaranteed within these ranges.

2. These ratings are guarantees that apply when the standard Matsushita packages are used.

3. The term  $V_n$  above refers to VHC, VH, VM, VL, and VLC. These must be set up so that the following conditions hold:  
 $VHC \geq VH \geq VM \geq VL \geq VLC = V_{SS}$ .

4. When power is first applied, certain voltage application sequences may result in large currents flowing in this IC and permanent damage to the IC. To prevent this, always apply the logic system power supply levels ( $V_{DD}$  and  $V_{SS}$ ) first, and only after those levels are established apply the LCD drive system power supply levels. Note that the conditions in note 3 above must be met at all times during this process.

### 2. Operating Conditions at $V_{SS} = 0\text{ V}$ , $T_a = -20^\circ\text{C}$ to $75^\circ\text{C}$

Parameter	Symbol	Conditions	Min	Typ	Max	Unit
Supply voltage	$V_{DD}$		2.5	3.3	5.5	V
Drive voltage	VHC		3.0	4.2	6.0	V
Drive voltage	VH		VHC - 0.7	VHC - 0.3	VHC	V
Drive voltage	VM		VL	—	VH	V
Drive voltage	VL		0	0.3	0.7	V

## ■ Electrical Characteristics (continued)

### 2. Operating Conditions at $V_{SS} = 0\text{ V}$ , $T_a = -20^\circ\text{C}$ to $75^\circ\text{C}$ (continued)

Parameter	Symbol	Conditions	Min	Typ	Max	Unit
Clock frequency	$f_{CP}$	$V_{DD} = 2.5\text{ V}$ to $4.5\text{ V}$	—	—	30	MHz
		$V_{DD} = 4.5\text{ V}$ to $5.5\text{ V}$	—	—	55	MHz
Digital signal input pin capacitance †1	$C_{in}$	At 1 MHz	—	6	—	pF
Rise and fall time for CP, LP, and D0 to D11	$t_r, t_f$	The following condition must be met: $t_r, t_f \leq 1/2(1/f - 2t_w)$ Here, f is the frequency used and $t_w$ is the minimum pulse width.	$2.5\text{ V}$ to $4.5\text{ V}$	—	—	ns
			$4.5\text{ V}$ to $5.5\text{ V}$	—	—	ns

Note) 1. †1: CP, D0 to D7

2. The VLC drive voltage is shorted to  $V_{SS}$  internally to the IC. Thus  $V_{LC} = V_{SS}$ .

3. Connect directly each of the multiple drive supply pins of VHC, VH, VM, VL, and VLC.

### 3. DC Characteristics at $V_{SS} = 0\text{ V}$ , $V_{DD} = 2.5\text{ V}$ to $5.5\text{ V}$ , $T_a = -20^\circ\text{C}$ to $+75^\circ\text{C}$

Parameter	Symbol	Conditions	Min	Typ	Max	Unit
Operating supply current	$I_{DD}$	$f_{CP} = 20\text{ MHz}$ $f_{Dn} = 10\text{ MHz}$ $f_{LP} = 36\text{ kHz}$	—	2	6	mA
Quiescent supply current (8-bit parallel input mode)	$I_{SS1}$	In the clock stopped state with MOD = open	—	—	100	$\mu\text{A}$
Quiescent supply current (4-bit parallel input mode)	$I_{SS2}$	In the clock stopped state with MOD = low	—	—	500	$\mu\text{A}$

#### 1) Input Pins (SHL, CP, LP, CL1, CL2, DF, D0 to D11, /DISPOFF)

High-level input voltage	$V_{IH1}$		$0.7 \times V_{DD}$	—	$V_{DD}$	V
Low-level input voltage	$V_{IL1}$		0	—	$0.3 \times V_{DD}$	V
Input leakage current	$I_{LI1}$		-10	—	10	$\mu\text{A}$

#### 2) Input with Pull-up Resistor Pins (MOD)

High-level input voltage	$V_{IH2}$		$0.7 \times V_{DD}$	—	$V_{DD}$	V
Low-level input voltage	$V_{IL2}$		0	—	$0.3 \times V_{DD}$	V
Pull-up resistance	$R_{PU2}$	$V_{DD} = 3.3\text{ V}$ , MOD = 0 V	30	100	300	$\text{K}\Omega$

#### 3) I/O Pins (/ER, /EL)

High-level input voltage	$V_{IH3}$		$0.7 \times V_{DD}$	—	$V_{DD}$	V
Low-level input voltage	$V_{IL3}$		0	—	$0.3 \times V_{DD}$	V
Input leakage current	$I_{LI3}$		-10	—	10	$\mu\text{A}$
High-level output voltage	$V_{OH3}$	$I_{OH} = -0.5\text{ mA}$	$V_{DD} - 0.5$	—	—	V
Low-level output voltage	$V_{OL3}$	$I_{OL} = 0.5\text{ mA}$		—	0.5	V
Output leakage current	$I_{LO3}$		-10	—	10	$\mu\text{A}$

### ■ Electrical Characteristics (continued)

#### 3. DC Characteristics at $V_{SS} = 0\text{ V}$ , $V_{DD} = 2.5\text{ V to }5.5\text{ V}$ , $T_a = -20^\circ\text{C to }+75^\circ\text{C}$ (continued)

Parameter	Symbol	Conditions	Min	Typ	Max	Unit	
4) LCD Drive Outputs (O1 to O320)		$V_{SS} = 0\text{ V}$ , $V_{DD} = 2.5\text{ V}$ , $T_a = -20^\circ\text{C to }+75^\circ\text{C}$					
Output on resistance	$R_{ON}$	VHC = 4.2 V	VHC	—	450	900	$\Omega$
		VH = 3.9 V	VH	—	450	900	
		VM = 2.1 V	VM	—	450	900	
		VL = 0.3 V	VL	—	450	900	
		VLC = 0.0 V $V_n - V_o = 0.5\text{ V}$ $V_o$ : Applied voltage of O1 to O320	VLC	—	450	900	
Output on resistance Variations between drive voltages	$R_{ON1}$	VHC = 4.2 V VH = 3.9 V	—	—	200	$\Omega$	
Output on resistance Variations between pins	$R_{ON2}$	VM = 2.1 V VL = 0.3 V VLC = 0.0 V	—	—	200	$\Omega$	

#### 4. AC Characteristics at $V_{SS} = 0\text{ V}$ , $V_{DD} = 2.5\text{ V to }5.5\text{ V}$ , $T_a = -20^\circ\text{C to }+75^\circ\text{C}$

Parameter	Symbol	Conditions	Min	Typ	Max	Unit	
			$V_{DD}(\text{V})$				
CP cycle time	$t_p$		2.5 to 4.5	33.3	—	—	ns
			4.5 to 5.5	18	—	—	
CP high-level period	$t_{weH}$		2.5 to 4.5	13	—	—	ns
			4.5 to 5.5	6	—	—	
CP low-level period	$t_{weL}$		2.5 to 4.5	13	—	—	ns
			4.5 to 5.5	6	—	—	
LP high-level period	$t_{wlH}$		2.5 to 5.5	40	—	—	ns
LP setup time 1	$t_{st1}$	CP-LP	2.5 to 4.5	15	—	—	ns
			4.5 to 5.5	10	—	—	
LP setup time 2	$t_{st2}$	CP-LP	2.5 to 4.5	10	—	—	ns
			4.5 to 5.5	10	—	—	
LP hold time 1	$t_{hd1}$	CP-LP	2.5 to 4.5	15	—	—	ns
			4.5 to 5.5	10	—	—	
LP hold time 2	$t_{hd2}$	CP-LP	2.5 to 4.5	50	—	—	ns
			4.5 to 5.5	25	—	—	
Data setup time	$t_{st3}$	CP-Dx	2.5 to 4.5	12	—	—	ns
			4.5 to 5.5	8	—	—	
Data hold time	$t_{hd3}$	CP-Dx	2.5 to 4.5	12	—	—	ns
			4.5 to 5.5	7	—	—	

■ Electrical Characteristics (continued)

4. AC Characteristics at  $V_{SS} = 0\text{ V}$ ,  $V_{DD} = 2.5\text{ V to }5.5\text{ V}$ ,  $T_a = -20^\circ\text{C to }+75^\circ\text{C}$  (continued)

Parameter	Symbol	Conditions	Min	Typ	Max	Unit	
			$V_{DD}(V)$				
Carry signal setup time	$t_{st4}$		2.5 to 4.5	12	—	—	ns
			4.5 to 5.5	6	—	—	
Carry signal output delay time	$t_{d1}$		2.5 to 4.5	—	—	21	ns
			4.5 to 5.5	—	—	12	
LP rising edge to CL2 rising edge time	$t_{cl1}$		18	—	—	ns	
CL2 rising edge to LP falling edge time	$t_{cl1}$		18	—	—	ns	
CL2 falling edge to CL1 rising edge time	$t_{cc}$		2	—	—	$\mu\text{s}$	
LP rising edge to DF rising edge time, DF falling edge time	$t_{d}$		40	—	—	ns	
LCD drive signal output delay time 1	$t_{d2}$	LP $\rightarrow$ O <sub>n</sub>	—	—	250	ns	
LCD drive signal output delay time 2	$t_{d3}$	CL1 $\rightarrow$ O <sub>n</sub>	—	—	250	ns	
LCD drive signal output delay time 3	$t_{d4}$	CL2 $\rightarrow$ O <sub>n</sub>	—	—	250	ns	
LCD drive signal output delay time 4	$t_{d5}$	DF $\rightarrow$ O <sub>n</sub>	—	—	250	ns	
LCD drive signal output delay time 5	$t_{d6}$	/DISPOFF $\rightarrow$ O <sub>n</sub>	—	—	250	ns	

■ Electrical Characteristics (continued)

4. AC Characteristics (continued)

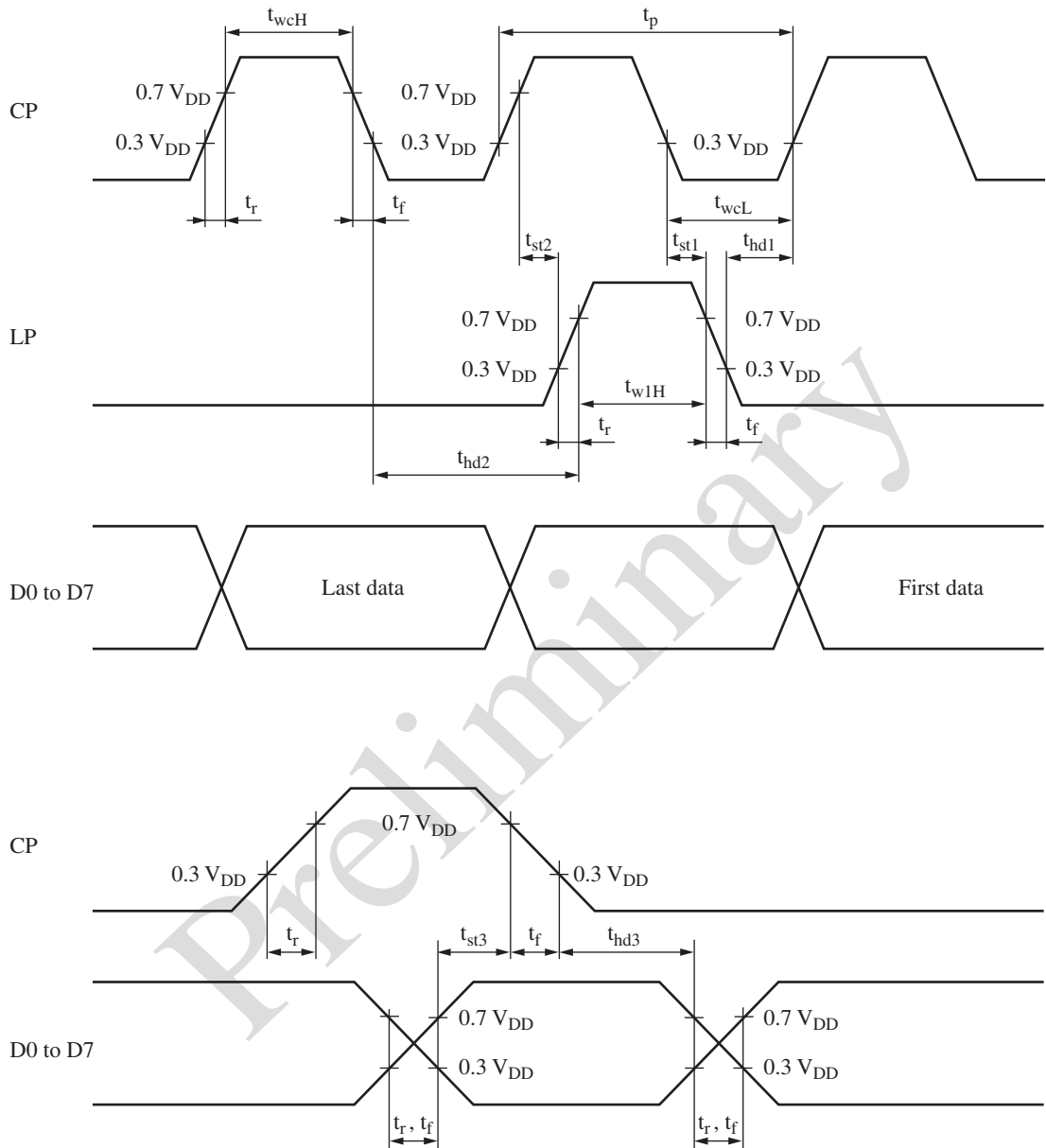

■ Electrical Characteristics (continued)

4. AC Characteristics (continued)

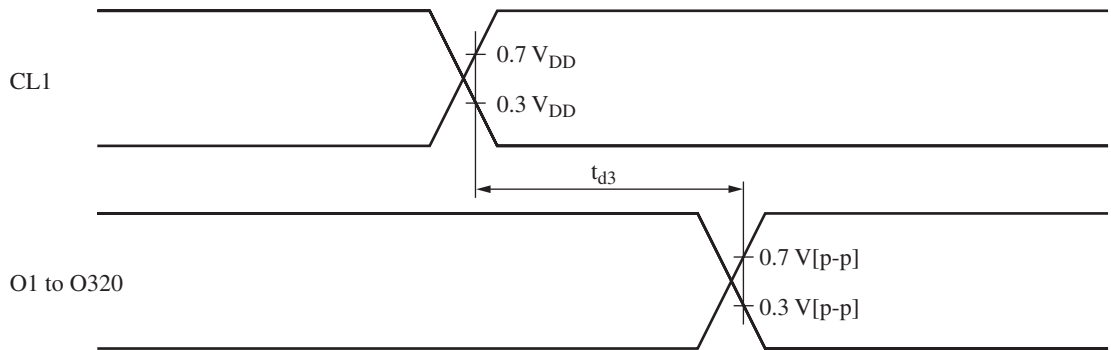
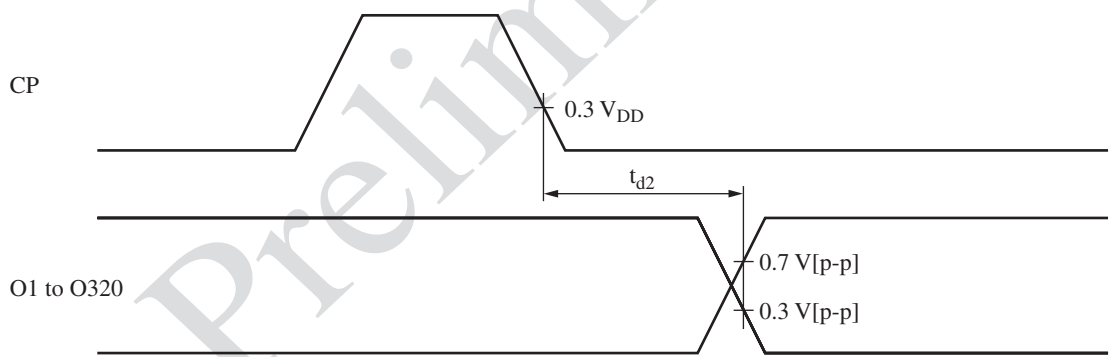
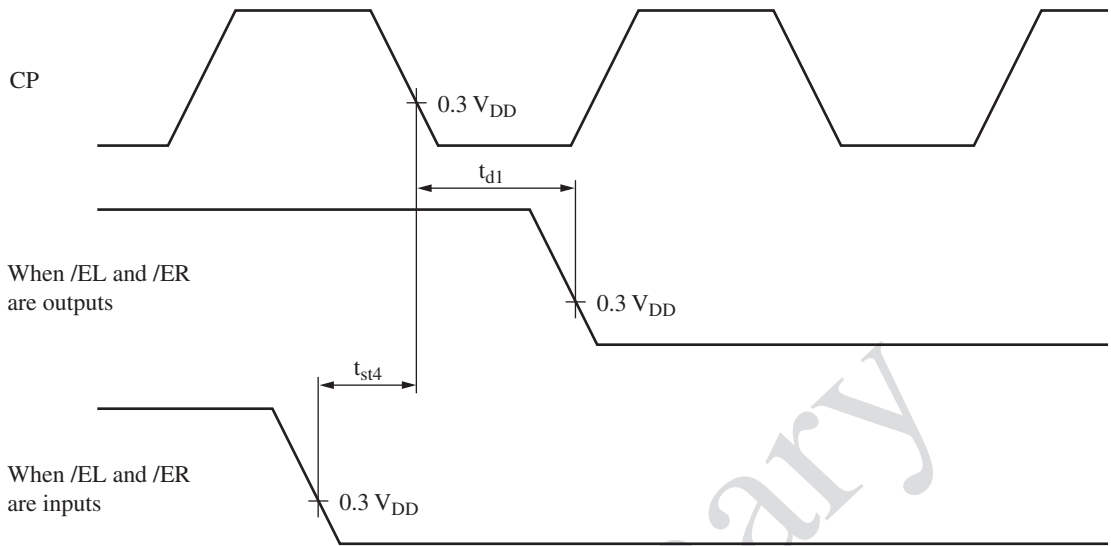

■ Electrical Characteristics (continued)

4. AC Characteristics (continued)

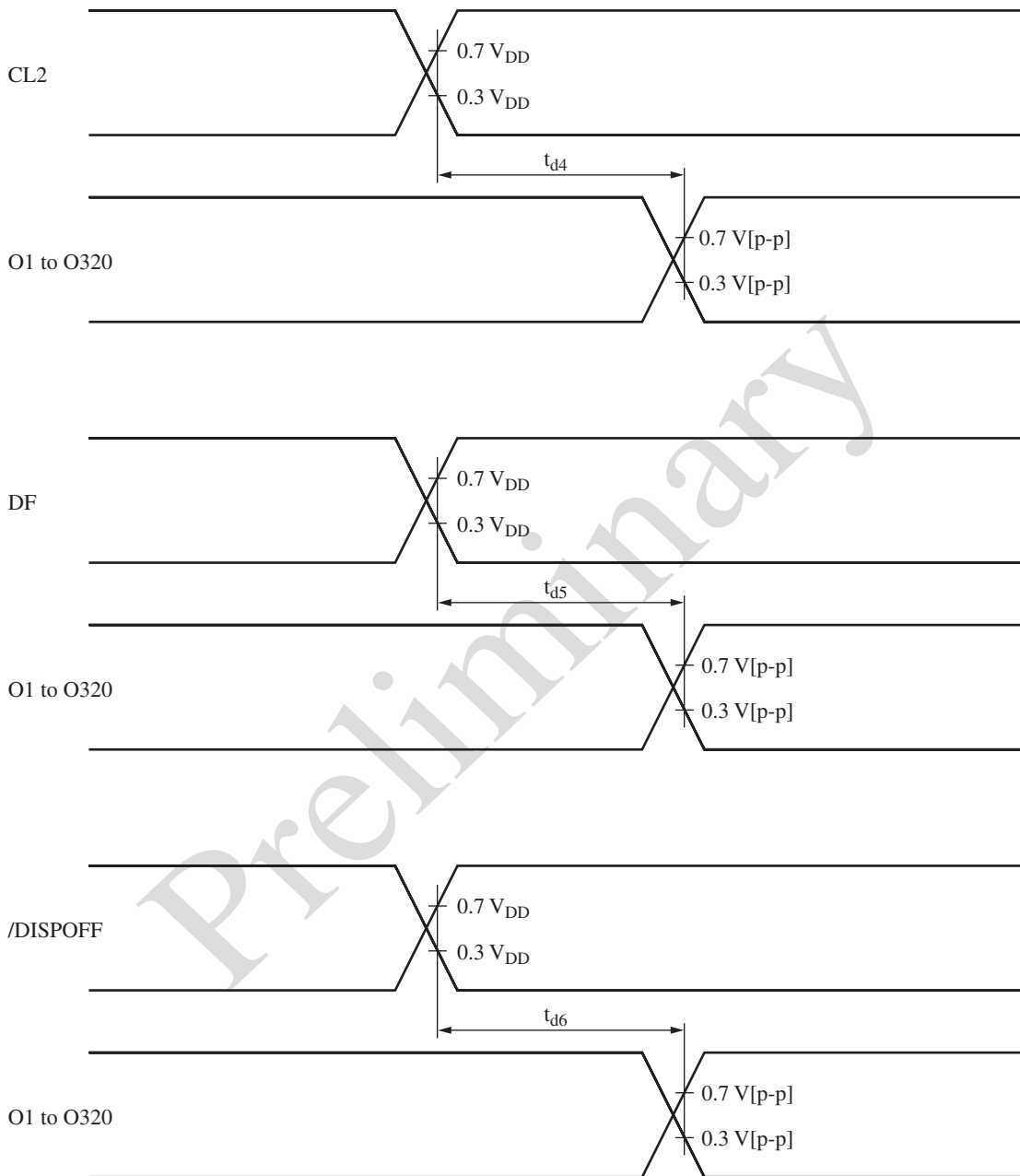

■ Electrical Characteristics (continued)

4. AC Characteristics (continued)

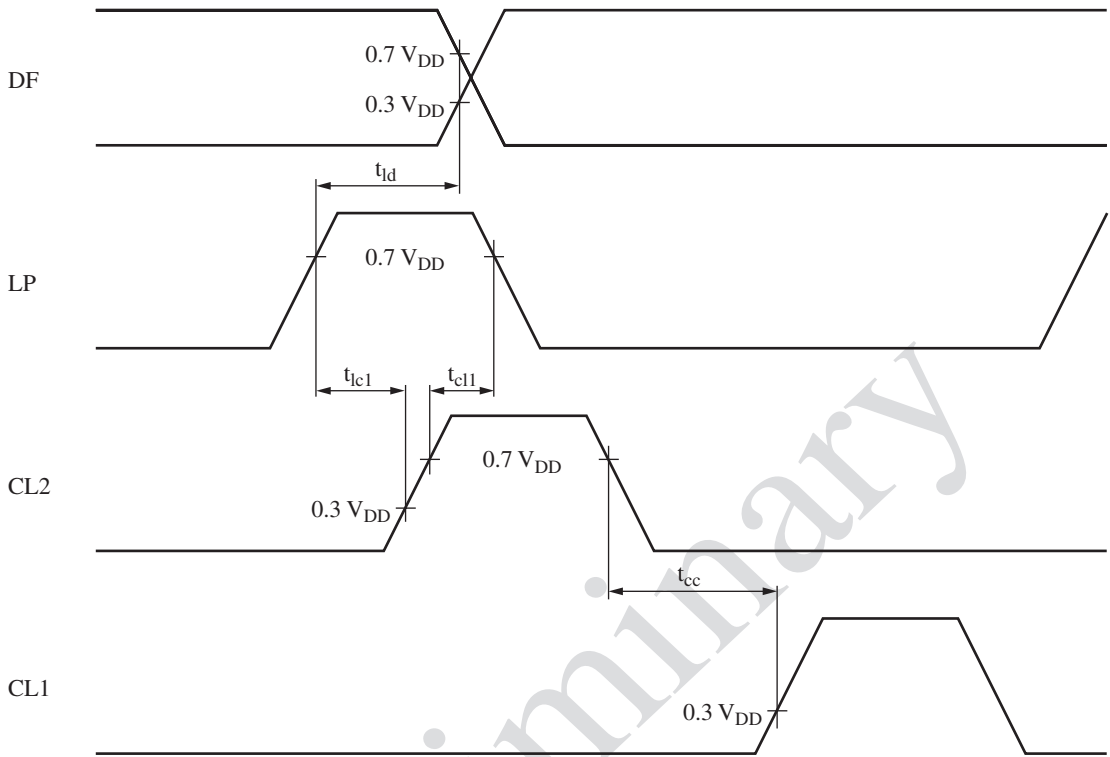



## Request for your special attention and precautions in using the technical information and semiconductors described in this material

- (1) An export permit needs to be obtained from the competent authorities of the Japanese Government if any of the products or technologies described in this material and controlled under the "Foreign Exchange and Foreign Trade Law" is to be exported or taken out of Japan.
- (2) The technical information described in this material is limited to showing representative characteristics and applied circuit examples of the products. It does not constitute the warranting of industrial property, the granting of relative rights, or the granting of any license.
- (3) The products described in this material are intended to be used for standard applications or general electronic equipment (such as office equipment, communications equipment, measuring instruments and household appliances).  
Consult our sales staff in advance for information on the following applications:
  - Special applications (such as for airplanes, aerospace, automobiles, traffic control equipment, combustion equipment, life support systems and safety devices) in which exceptional quality and reliability are required, or if the failure or malfunction of the products may directly jeopardize life or harm the human body.
  - Any applications other than the standard applications intended.
- (4) The products and product specifications described in this material are subject to change without notice for reasons of modification and/or improvement. At the final stage of your design, purchasing, or use of the products, therefore, ask for the most up-to-date Product Standards in advance to make sure that the latest specifications satisfy your requirements.
- (5) When designing your equipment, comply with the guaranteed values, in particular those of maximum rating, the range of operating power supply voltage and heat radiation characteristics. Otherwise, we will not be liable for any defect which may arise later in your equipment.  
Even when the products are used within the guaranteed values, redundant design is recommended, so that such equipment may not violate relevant laws or regulations because of the function of our products.
- (6) When using products for which dry packing is required, observe the conditions (including shelf life and after-unpacking standby time) agreed upon when specification sheets are individually exchanged.
- (7) No part of this material may be reprinted or reproduced by any means without written permission from our company.

## Please read the following notes before using the datasheets

- A. These materials are intended as a reference to assist customers with the selection of Panasonic semiconductor products best suited to their applications.  
Due to modification or other reasons, any information contained in this material, such as available product types, technical data, and so on, is subject to change without notice.  
Customers are advised to contact our semiconductor sales office and obtain the latest information before starting precise technical research and/or purchasing activities.
- B. Panasonic is endeavoring to continually improve the quality and reliability of these materials but there is always the possibility that further rectifications will be required in the future. Therefore, Panasonic will not assume any liability for any damages arising from any errors etc. that may appear in this material.
- C. These materials are solely intended for a customer's individual use.  
Therefore, without the prior written approval of Panasonic, any other use such as reproducing, selling, or distributing this material to a third party, via the Internet or in any other way, is prohibited.