

1 Form A Solid State Relay

Features

- Isolation Test Voltage 5300 V_{RMS}
- Current-limit Protection Built-in
- High-reliability Monolithic output die
- Low Power Consumption
- Clean, Bounce-free Switching
- High Surge Capability
- Surface Mountable
- Lead-free component
- Component in accordance to RoHS 2002/95/EC and WEEE 2002/96/EC

Agency Approvals

- UL1577, File No. E52744 System Code H or J, Double Protection
- CSA - Certification 093751
- BSI/BABT Cert. No. 7980
- DIN EN 60747-5-2 (VDE0884)
DIN EN 60747-5-5 pending
- FIMKO Approval

Applications

General Telecom Switching

- On/off-hook
- Ring Relay/ Dial Pulse
- Ground Start/ Fault Protection

Instrumentation

- Automatic Tuning/Balancing
- Flying Capacitor

Analog Multiplex

Industrial Controls

- Triac Predrivers
- Output Modules

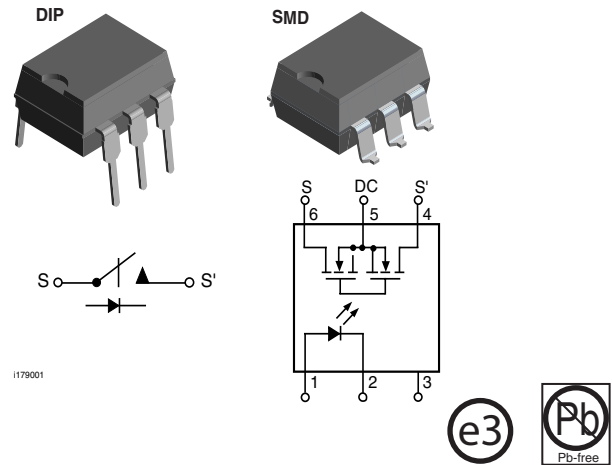

Peripherals - Transducer Driver

Description

The LH1510 is a SPST normally open switch (1 Form A) that can replace electromechanical relays in many applications. The relay is constructed using a GaAlAs LED for actuation control and an integrated monolithic die for the switch output. The die, fabricated in a high-voltage dielectrically isolated technology, is comprised of a photodiode array, switch control circuitry, and MOSFET switches. In addition, the relay employs current-limiting circuitry enabling it to pass FCC 68.302 and other regulatory voltage surge requirements when overvoltage protection is provided. The LH1510 is the only relay in the family that provides current limiting for unidirectional dc applications.

Order Information

Part	Remarks
LH1510AAB	Tubes, SMD-6
LH1510AABTR	Tape and Reel, SMD-6
LH1510AT	Tubes, DIP-6

Absolute Maximum Ratings, $T_{amb} = 25\text{ }^{\circ}\text{C}$

Stresses in excess of the absolute Maximum Ratings can cause permanent damage to the device. Functional operation of the device is not implied at these or any other conditions in excess of those given in the operational sections of this document. Exposure to absolute Maximum Ratings for extended periods of time can adversely affect reliability.

SSR

Parameter	Test condition	Symbol	Value	Unit
LED continuous forward current		I_F	50	mA
LED reverse voltage	$I_R \leq 10\text{ }\mu\text{A}$	V_R	8.0	V
DC or peak AC load voltage	$I_L \leq 50\text{ }\mu\text{A}$	V_L	200	V
Continuous DC load current - bidirectional operation		I_L	200	mA
Continuous DC load current - unidirectional operation		I_L	350	mA
Peak load current (single shot)	$t = 100\text{ ms}$	I_P	1)	
Ambient temperature range		T_{amb}	- 40 to + 85	$^{\circ}\text{C}$
Storage temperature range		T_{stg}	- 40 to + 150	$^{\circ}\text{C}$
Pin soldering temperature	$t = 10\text{ s max}$	T_{sld}	260	$^{\circ}\text{C}$
Input/output isolation voltage		V_{ISO}	5300	V_{RMS}
Output power dissipation (continuous)		P_{diss}	550	mW

1) Refer to Current Limit Performance Application Note 58 for a discussion on relay operation during transient currents.

Electrical Characteristics, $T_{amb} = 25\text{ }^{\circ}\text{C}$

Minimum and maximum values are testing requirements. Typical values are characteristics of the device and are the result of engineering evaluations. Typical values are for information only and are not part of the testing requirements.

Input

Parameter	Test condition	Symbol	Min	Typ.	Max	Unit
LED forward current, switch turn-on	$I_L = 100\text{ mA}$, $t = 10\text{ ms}$	I_{Fon}		0.95	2.0	mA
LED forward current, switch turn-off	$V_L = \pm 150\text{ V}$	I_{Foff}	0.2	0.85		mA
LED forward voltage	$I_F = 10\text{ mA}$	V_F	1.15	1.27	1.45	V

Output

Parameter	Test condition	Symbol	Min	Typ.	Max	Unit
ON-resistance ac/dc: Pin 4(±) to 6 (±)	$I_F = 5.0\text{ mA}$, $I_L = 50\text{ mA}$	R_{ON}	6.0	11.27	15	Ω
ON-resistance dc: Pin 4, 6 (+) to 5 (±)	$I_F = 5.0\text{ mA}$, $I_L = 100\text{ mA}$	R_{ON}	1.5	3.15	3.75	Ω
Off-resistance	$I_F = 0\text{ mA}$, $V_L = \pm 100\text{ V}$	R_{OFF}	0.5	80		$G\Omega$
Current limit ac/dc: Pin 4 (±) to 6 (±)	$I_F = 5.0\text{ mA}$, $V_L = \pm 5.0\text{ V}$, $t = 5.0\text{ ms}$	I_{LMT}	300	368	450	mA
Current limit dc: Pin 4, 6 (+) to 5 (±)	$I_F = 5.0\text{ mA}$, $V_L = 4.0\text{ V}$, $t = 5.0\text{ ms}$	I_{LMT}	600	736	920	mA
Off-state leakage current	$I_F = 0\text{ mA}$, $V_L = \pm 100\text{ V}$	I_O		2.36	200	nA
	$I_F = 0\text{ mA}$, $V_L = \pm 200\text{ V}$	I_O		79.2	1.0	μA

Parameter	Test condition	Symbol	Min	Typ.	Max	Unit
Output capacitance Pin 4 to 6	$I_F = 0 \text{ mA}, V_L = 1.0 \text{ V}$	C_O		27.75		pF
	$I_F = 0 \text{ mA}, V_L = 50 \text{ V}$	C_O		10.82		pF
Switch offset	$I_F = 5.0 \text{ mA}$	V_{OS}		0.17		μV

Transfer

Parameter	Test condition	Symbol	Min	Typ.	Max	Unit
Capacitance (input-output)	$V_{ISO} = 1.0 \text{ V}$	C_{IO}		0.72		pF
Turn-on time	$I_F = 5.0 \text{ mA}, I_L = 50 \text{ mA}$	t_{on}		0.5	2.0	ms
Turn-off time	$I_F = 5.0 \text{ mA}, I_L = 50 \text{ mA}$	t_{off}		0.7	2.0	ms

Typical Characteristics ($T_{amb} = 25^\circ\text{C}$ unless otherwise specified)

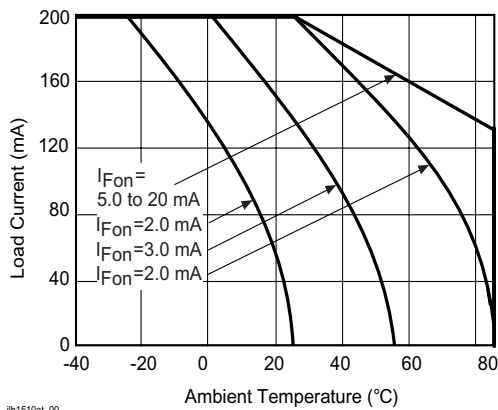

Figure 1. Recommended Operating Conditions

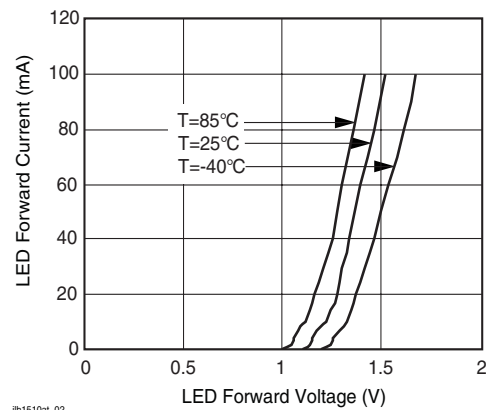

Figure 3. LED Forward Current vs. LED Forward Voltage

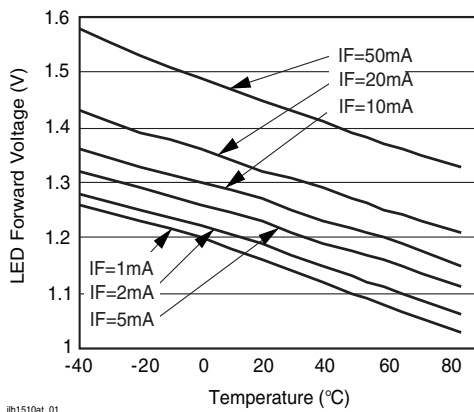

Figure 2. LED Voltage vs. Temperature

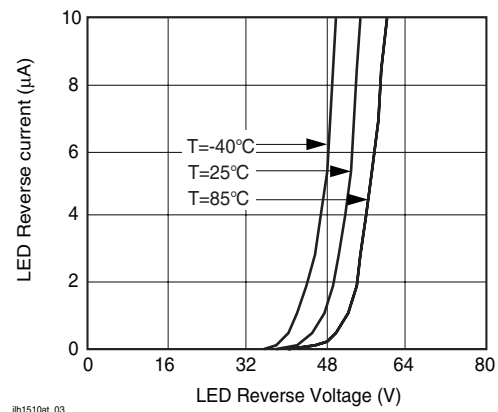

Figure 4. LED Reverse Current vs. LED Reverse Voltage

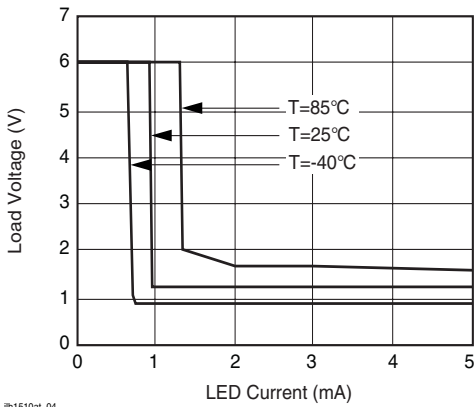

Figure 5. LED Current vs. Load Voltage

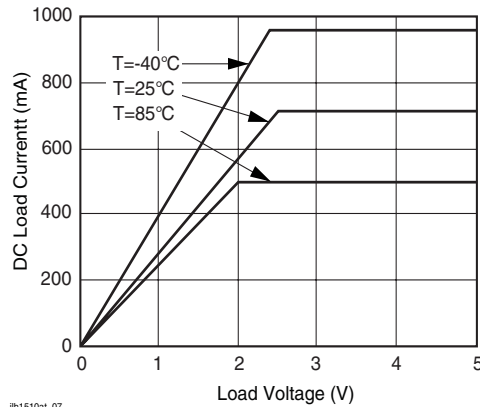

Figure 8. DC Load Current vs. Load Voltage

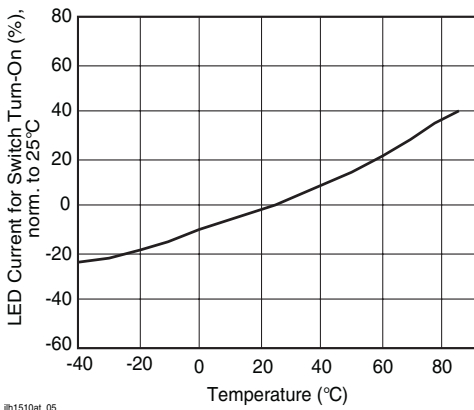

Figure 6. LED Current for Switch Turn-on vs. Temperature

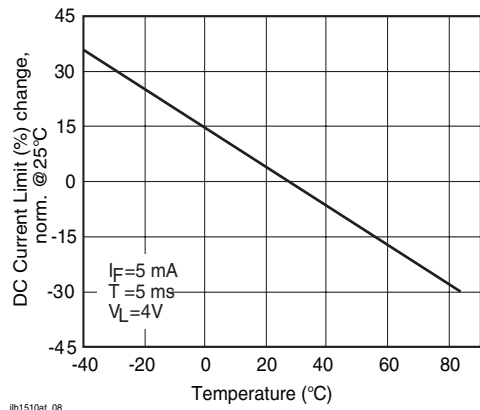

Figure 9. DC Current Limit vs. Temperature

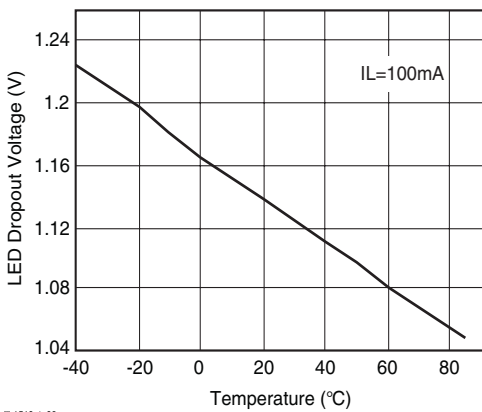

Figure 7. LED Dropout Voltage vs. Temperature

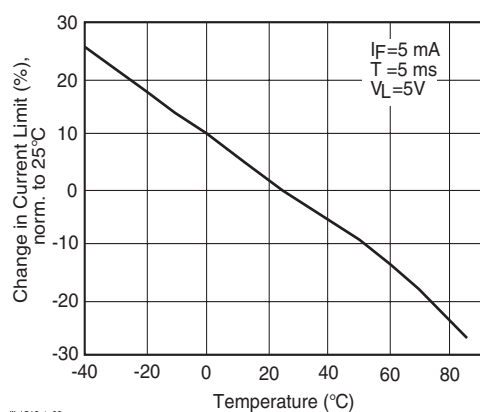
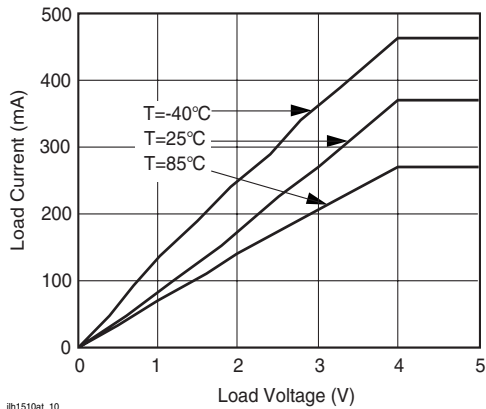
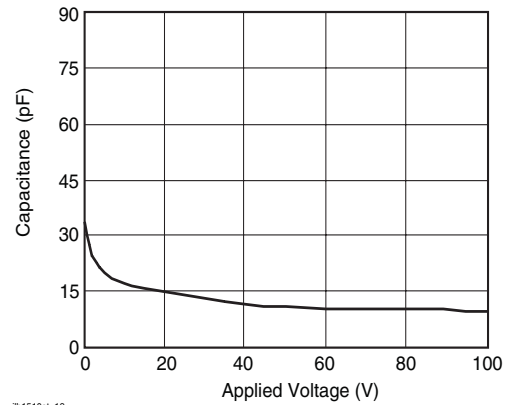

Figure 10. Current Limit vs. Temperature



ih1510at_10

Figure 11. Load Current vs. Load Voltage



ih1510at_13

Figure 14. Switch Terminal Capacitance vs. Applied Voltage

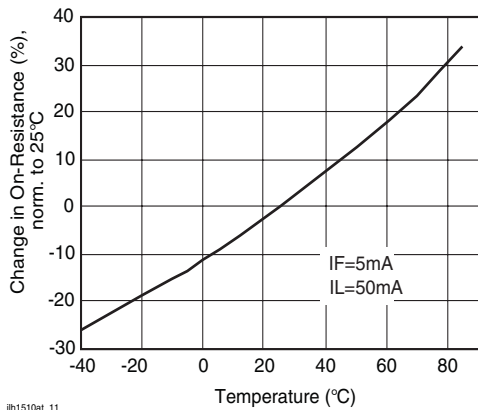

ih1510at_11

Figure 12. ON-Resistance vs. Temperature

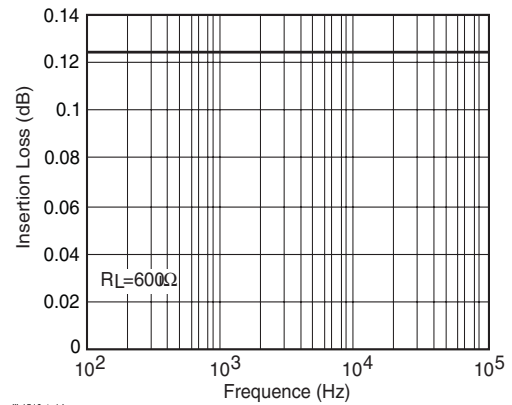

ih1510at_14

Figure 15. Insertion Loss vs. Frequency

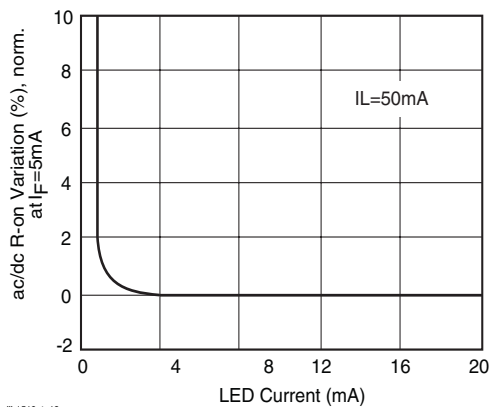

ih1510at_12

Figure 13. Variation in ON-Resistance vs. LED Current

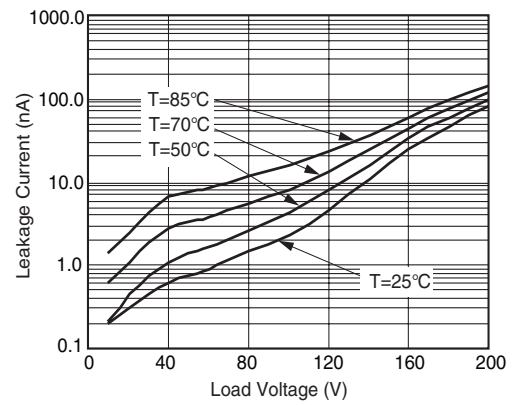

ih1510at_15

Figure 16. Leakage Current vs. Applied Voltage

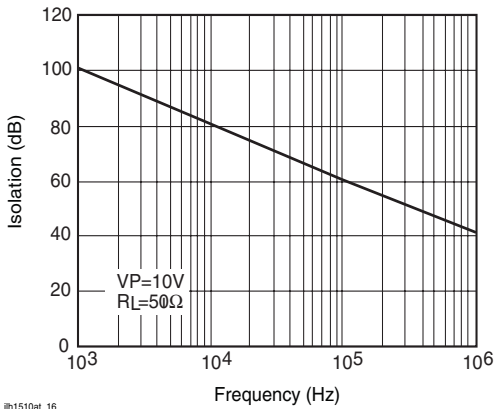

Figure 17. Output Isolation

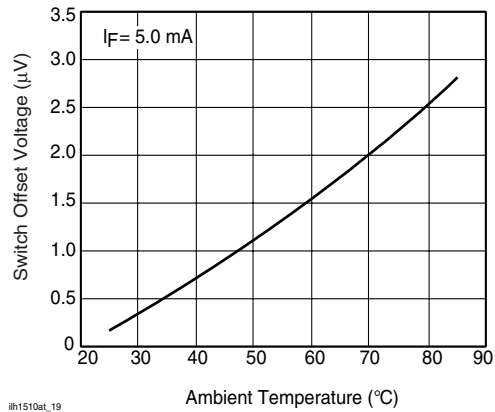

Figure 20. Switch Offset Voltage vs. Temperature

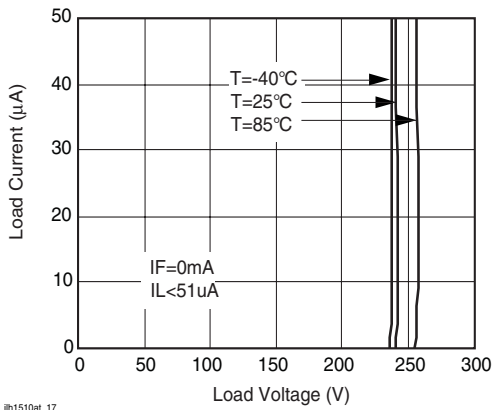

Figure 18. Switch Breakdown Voltage vs. Load Current

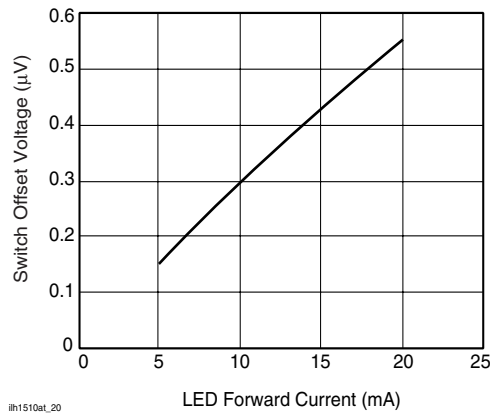

Figure 21. Switch Offset Voltage vs. LED Current

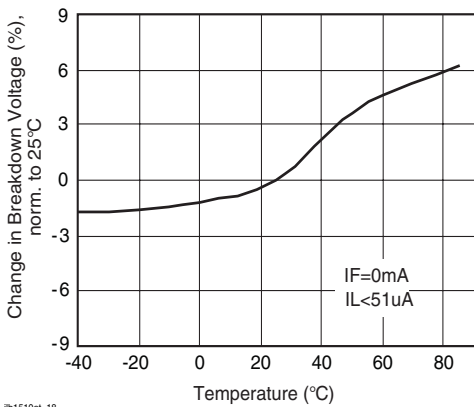

Figure 19. Switch Breakdown Voltage vs. Temperature

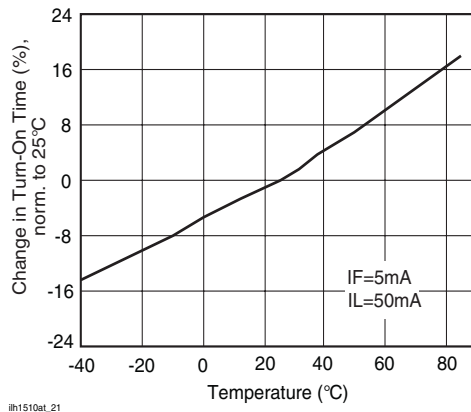
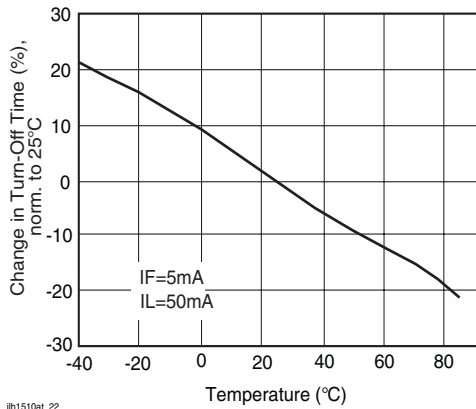
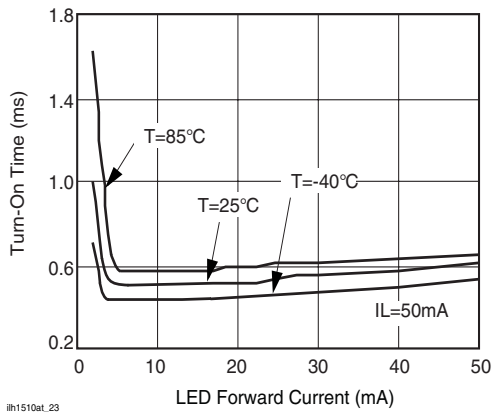

Figure 22. Turn-on Time vs. Temperature



ih1510at_22

Figure 23. Turn-off Time vs. Temperature



ih1510at_23

Figure 24. Turn-on Time vs. LED Current

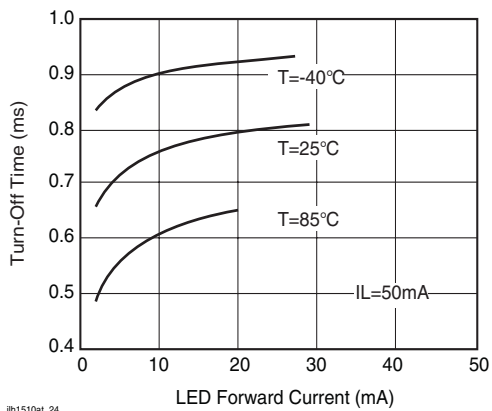

ih1510at_24

Figure 25. Turn-off Time vs. LED Current

LH1510AAB/ AABTR/ AT



Vishay Semiconductors

Package Dimensions in Inches (mm)

DIP

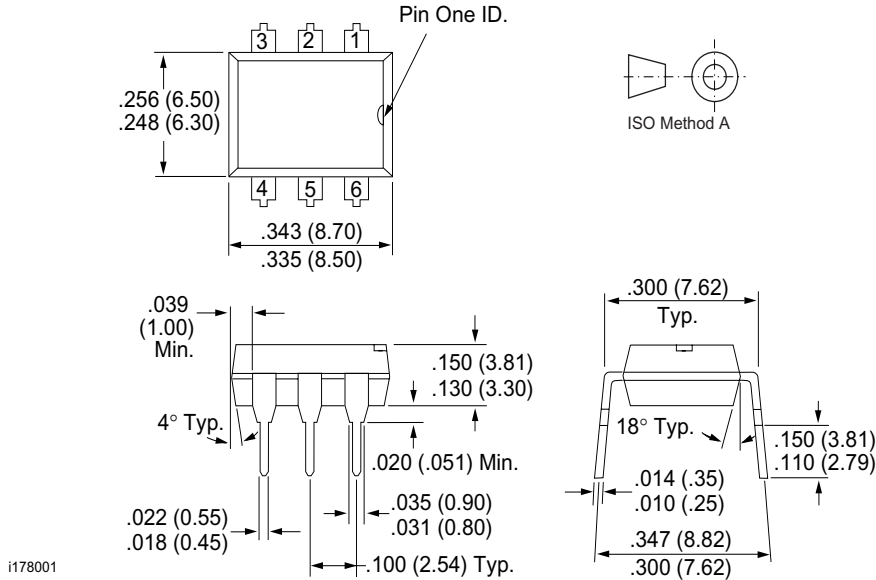

Package Dimensions in Inches (mm)

SMD

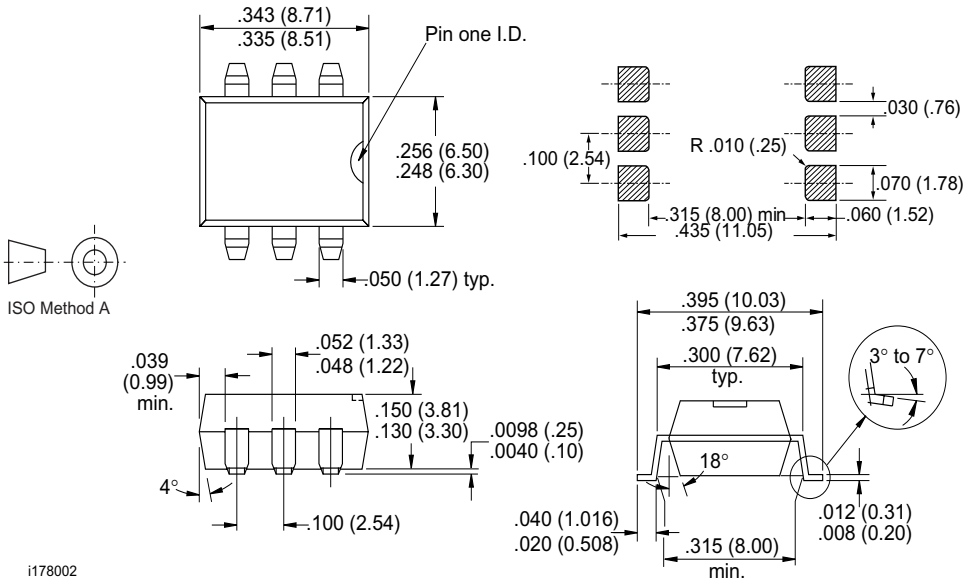



Ozone Depleting Substances Policy Statement

It is the policy of Vishay Semiconductor GmbH to

1. Meet all present and future national and international statutory requirements.
2. Regularly and continuously improve the performance of our products, processes, distribution and operating systems with respect to their impact on the health and safety of our employees and the public, as well as their impact on the environment.

It is particular concern to control or eliminate releases of those substances into the atmosphere which are known as ozone depleting substances (ODSs).

The Montreal Protocol (1987) and its London Amendments (1990) intend to severely restrict the use of ODSs and forbid their use within the next ten years. Various national and international initiatives are pressing for an earlier ban on these substances.

Vishay Semiconductor GmbH has been able to use its policy of continuous improvements to eliminate the use of ODSs listed in the following documents.

1. Annex A, B and list of transitional substances of the Montreal Protocol and the London Amendments respectively
2. Class I and II ozone depleting substances in the Clean Air Act Amendments of 1990 by the Environmental Protection Agency (EPA) in the USA
3. Council Decision 88/540/EEC and 91/690/EEC Annex A, B and C (transitional substances) respectively.

Vishay Semiconductor GmbH can certify that our semiconductors are not manufactured with ozone depleting substances and do not contain such substances.

We reserve the right to make changes to improve technical design and may do so without further notice.

Parameters can vary in different applications. All operating parameters must be validated for each customer application by the customer. Should the buyer use Vishay Semiconductors products for any unintended or unauthorized application, the buyer shall indemnify Vishay Semiconductors against all claims, costs, damages, and expenses, arising out of, directly or indirectly, any claim of personal damage, injury or death associated with such unintended or unauthorized use.

Vishay Semiconductor GmbH, P.O.B. 3535, D-74025 Heilbronn, Germany
Telephone: 49 (0)7131 67 2831, Fax number: 49 (0)7131 67 2423