

DATA SHEET

TDA1592

PLL stereo decoder and noise
blanker

Preliminary specification
Supersedes data of June 1993
File under Integrated Circuits, IC01

1996 May 31

PLL stereo decoder and noise blanker**TDA1592****FEATURES**

- Adjustment-free voltage controlled PLL oscillator for ceramic resonator ($f = 456$ kHz)
- Pilot signal dependent mono/stereo switching
- Analog control of mono/stereo change over [stereo blend, Stereo Noise Controller (SNC)]
- Adjacent channel noise suppression (114 kHz)
- Pilot canceller
- Analog control of de-emphasis; High Cut Control (HCC)
- Reduced and controlled de-emphasis for AM operation (pin 7 to GND)
- Applicable as source selector for AM/FM/cassette switching
- Soft mute for silent tuning
- Separate interference noise detector
- Integrated input low-pass filter for delayed noise blanking
- Noise blanking at MPX-demodulator outputs.

GENERAL DESCRIPTION

The TDA1592 is a monolithic bipolar integrated circuit providing the stereo decoder function and noise blanking for FM car radio applications.

The device operates in a power supply range of 7.5 to 12 V.

QUICK REFERENCE DATA

SYMBOL	PARAMETER	MIN.	TYP.	MAX.	UNIT
V_P	supply voltage (pin 5)	7.5	10	12	V
I_P	supply current	–	15	20	mA
$V_{o(rms)}$	audio output signal (RMS value)	800	900	1000	mV
THD	total harmonic distortion	–	0.1	0.3	%
S/N	signal-to-noise ratio	–	82	–	dB
α_{cs}	channel separation	30	40	–	dB
V_{trigg}	interference voltage trigger level	–	10	–	mV

ORDERING INFORMATION

TYPE NUMBER	PACKAGE		
	NAME	DESCRIPTION	VERSION
TDA1592	DIP20	plastic dual in-line package; 20 leads (300 mil)	SOT146-1
TDA1592T	SO20	plastic small outline package; 20 leads; body width 7.5 mm	SOT163-1

PLL stereo decoder and noise blanker

TDA1592

PINNING

SYMBOL	PIN	DESCRIPTION
PLL	1	phase locked loop filter
OSC	2	oscillator input/output pin for ceramic resonator
GND	3	ground (0 V)
I _{ref}	4	reference current
V _P	5	supply voltage (+10 V)
INFI	6	interference signal input
PUFO	7	pulse former time constant; VCO off
NDET	8	noise detector time constant; mute on
FB-L	9	AF feedback input for left audio signal
V _{oL}	10	AF output signal left
V _{oR}	11	AF output signal right
FB-R	12	AF feedback input for right audio signal
C _{DEEL}	13	de-emphasis capacitor for left channel
C _{DEER}	14	de-emphasis capacitor for right channel
HCC	15	HCC input for de-emphasis control
SNC	16	stereo blend input
V _{ref}	17	externally applied reference voltage of 1 to 5 V
IDENT	18	identification output (HIGH = pilot existing; stereo)
PILOT	19	pilot detector level (forced mono input)
V _{i MPX}	20	MPX input signal from IF demodulator

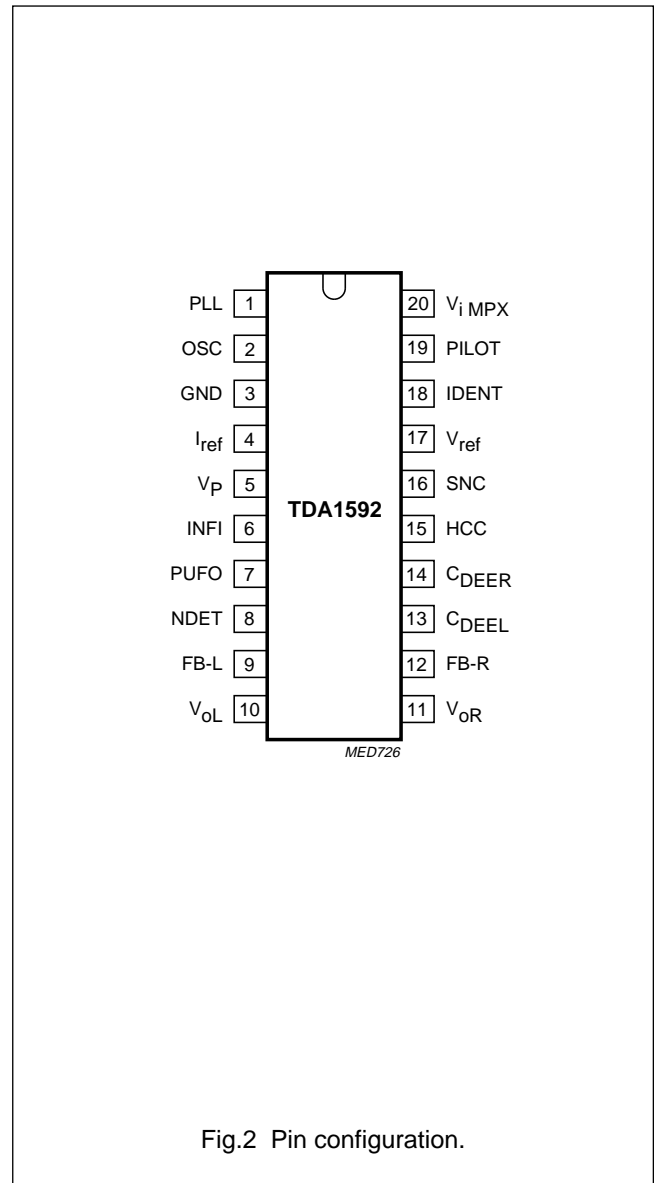

Fig.2 Pin configuration.

PLL stereo decoder and noise blanker

TDA1592

FUNCTIONAL DESCRIPTION

The MPX input of the TDA1592 (pin 20) is the null-node of an operational amplifier with internal feedback resistor. Adapting the stereo decoder input to the level of the FM demodulator output is realized by the value of input resistor R_{in} (see Fig.3). The total gain of the stereo decoder is applicable by varying the feedback resistors R_{out} (pins 9, 10, 11 and 12) of the output operational amplifiers (see Fig.4).

The input amplifier is followed by an integrated 4th order Bessel low-pass filter with a cut-off frequency of 80 kHz. It provides necessary signal delay for noise blanking and damping of high frequency interferences at the stereo decoder input.

The soft mute facility (pin 8) provides silent tuning for RDS processing. The mute time constant may be adjusted from pin 8. In mute position and the VCO switched **off** (pin 7), the output amplifiers can be used for cassette playback, AM stereo purpose or other signal sources.

The voltage to current converted MPX signal is fed to phase detector, pilot detector and pilot canceller circuits. The oscillator is alignment-free with an external ceramic resonator at 456 kHz as reference (pin 2). The required 19 kHz and 38 kHz signals are generated by division of the oscillator output signal in a logical circuit. For regeneration of the 38 kHz subcarrier, a PLL is used. The 19 kHz quadrature phase signal is fed to the 19 kHz phase detector, where it is compared with the incoming pilot tone. The DC output signal of the phase detector (pin 1) controls the oscillator (PLL).

The pilot presence detector is driven by internally generated in-phase 19 kHz. Its pilot-dependent DC output voltage (pin 19) is fed to a threshold switch, which activates the pilot indicator logic output (pin 18) and turns the stereo decoder to stereo operation. The same DC voltage is used to control the amplitude of an anti-phase internally generated 19 kHz signal. In the pilot canceller, the pilot tone is compensated by this anti-phase 19 kHz signal.

The pilot cancelled signal is fed to the multiplex decoder. There, the side signal is demodulated and combined with the main signal in a matrix to left and right audio channel.

Compensation for roll-off in the incoming MPX signal caused by IF filters and FM demodulator is realized by corresponding side signal amplification.

A smooth mono to stereo take-over, which is controlled by the level detector voltage of the IF part, is achieved by the SNC (pins 16 and 17; see Fig.6).

From the output of the MPX demodulator the signals are fed to 2-pole low-pass filters with a cut-off frequency of 30 kHz to provide additional signal delay for noise blanking and attenuation of the subcarrier and its harmonics.

These filters are followed by the noise suppression gates, which are combined with de-emphasis and HCC. The de-emphasis is defined by internal resistors (aligned by an external current) and external capacitors (pins 13 and 14). For HCC, the de-emphasis time constant can be changed to higher values (pins 15 and 17; see Figs 7 to 9). This function is controlled by an analog input signal, derived from the level detector voltage of the IF part. When the VCO is turned **off** (pin 7 to GND), de-emphasis is reduced to 20 μ s for full frequency response when AM-AF is fed through the stereo decoder. De-emphasis remains controllable.

From the gate circuits audio is fed through internal series resistors to the inverting inputs of the output operational amplifiers (pins 9 and 12), which can also be used as signal inputs for cassette playback or other sources when the mute is activated. The gain of these amplifiers is defined by external feedback resistors R_{out} (pins 9, 10, 11 and 12).

The input of the ignition noise blanker is the null node of an operational amplifier (pin 6). It can be driven by the level detector output of the FM-IF limiter and/or the MPX signal. Its sensitivity is dependent on the value of the series input resistor at pin 6.

The operational amplifier output signal is fed through an integrated 120 kHz high-pass filter, becomes amplified and is then fed in parallel to the noise detector and the interference detector. The noise detector is a negative peak detector. Its output (pin 8) controls the trigger sensitivity (prevention to false triggering at noisy input signals) and the attenuation of the input operational amplifier. The output of the interference detector, when receiving a steep pulse, triggers a mono flip-flop, which is a part of the pulse former circuit. The time constant of the mono flip-flop is defined by an external capacitor (pin 7) and its output activates the blanking gates in the audio.

PLL stereo decoder and noise blanker

TDA1592

LIMITING VALUES

In accordance with the Absolute Maximum Rating System (IEC 134).

SYMBOL	PARAMETER	MIN.	MAX.	UNIT
V_P	supply voltage (pin 5)	0	13.2	V
P_{tot}	total power dissipation	0	0.25	W
T_{stg}	storage temperature	-55	+150	°C
T_{amb}	operating ambient temperature	-40	+85	°C
V_{es}	electrostatic handling for all pins; note 1	-400	+400	V

Note

- Equivalent to discharging a 200 pF capacitor through a 0 Ω series resistor.

CHARACTERISTICS

$V_P = 10$ V; $T_{amb} = 25$ °C; input signal $V_{i\ MPX(p-p)} = 1.7$ V; $m = 100\%$ ($\Delta f = \pm 75$ kHz, $f_{mod} = 1$ kHz); de-emphasis of 50 μ s and series resistor at input $R_1 = 164$ k Ω ; measurements taken in Fig.1; unless otherwise specified.

SYMBOL	PARAMETER	CONDITIONS	MIN.	TYP.	MAX.	UNIT
V_P	supply voltage (pin 5)		7.5	10	12	V
I_P	supply current		–	15	20	mA
Stereo decoder						
$V_{i\ MPX(p-p)}$	MPX input signal		–	1.7	–	V
$\Delta V_{i\ MPX(p-p)}$	overdrive margin of MPX input signal	THD = 1%	6	–	–	dB
$V_{o(rms)}$	AF mono output signal at pins 10 and 11 (RMS value)	without pilot	800	900	1000	mV
ΔV_o	overdrive margin of output signal	THD = 1%	6	–	–	dB
V_{10-11}/V_o	difference of output voltage levels		–	–	1	dB
$V_{o\ 10,11}$	DC output voltage (pins 10 and 11)		3.2	3.7	4.2	V
$R_{o\ 10,11}$	output resistance		–	150	–	Ω
I_o	output current		330	400	–	μ A
$R_{2,3}$	maximum feedback resistor		–	–	68	k Ω
$V_{4,3}$	reference voltage		3.7	3.8	3.9	V
α_{cs}	channel separation	pin 16 open-circuit; see Fig.6	30	40	–	dB
THD	total harmonic distortion		–	0.1	0.3	%
S/N	signal-to-noise ratio	$f = 20$ to 16000 Hz	77	82	–	dB
α_{19}	pilot signal suppression	$f = 19$ kHz	40	50	–	dB
α_{38}	subcarrier suppression	$f = 38$ kHz	35	50	–	dB
α_{57}		$f = 57$ kHz	46	–	–	dB
α_{76}		$f = 76$ kHz	–	60	–	dB
IM2		intermodulation for $f_{spur} = 1$ kHz	$f_{mod} = 10$ kHz; note 1	–	60	–
IM3		$f_{mod} = 13$ kHz	–	58	–	dB
$\alpha_{57\ VF}$	traffic radio (VWF)	$f = 57$ kHz; note 2	–	70	–	dB
α_{67}	SCA (Subsidiary Communications Authorization)	$f = 67$ kHz; note 3	70	–	–	dB

PLL stereo decoder and noise blanker

TDA1592

SYMBOL	PARAMETER	CONDITIONS	MIN.	TYP.	MAX.	UNIT
α_{114}	ACI (Adjacent Channel Interference)	f = 114 kHz; note 4	–	80	–	dB
α_{190}		f = 190 kHz; note 4	–	70	–	dB
PSRR	power supply ripple rejection	f = 100 Hz; $V_{\text{ripple (rms)}} = 100 \text{ mV}$	–	35	–	dB
VCO (pin 2)						
f_{osc}	oscillator frequency (ceramic resonator)		–	456	–	kHz
	frequency range of free running oscillator		451	–	459	kHz
$\Delta f/f$	capture and holding range		–	± 0.65	–	%
V_7	VCO-off voltage (pin 7)		0	–	0.6	V
Mono/stereo control (pins 16, 17 and 19)						
$V_{i \text{ pilot}}$	pilot threshold voltage for automatic switching by pilot input voltage (RMS value)	stereo on	–	24	30	mV
		stereo off	8	20	–	mV
HYS	hysteresis of pilot threshold voltage		–	2	–	dB
V_{19}	switching voltage for external mono control (pin 19)		–	–	0.7	V
V_{ref}	reference input voltage range (pin 17)		1	–	5	V
V_{16-17}	control voltage for channel separation due to pin 17 (V_{ref})	$\alpha_{\text{CS}} = 6 \text{ dB}$; see Fig.5	–80	–100	–120	mV
		$\alpha_{\text{CS}} = 20 \text{ dB}$; see Fig.5	–40	–55	–70	mV
Pilot indicator logic level output (pin 18)						
V_{18}	LOW voltage	$I_{18} = 500 \mu\text{A}$	–	250	400	mV
I_{18}	HIGH current	$V_{18} = 10 \text{ V}$	–	–	1	μA
Muting (pin 8)						
MUTE_{att}	mute attenuation (pin 8)	$V_8 < 1.6 \text{ V}$	80	–	–	dB
		$V_8 > 4 \text{ V}$	–	–	0.2	dB
$V_{\text{O(offset)}}$	DC offset voltage (pins 10 and 11)	after muting	–	–	± 50	mV
HCC (pin 15)						
CR_{deem}	control range of de-emphasis for European standard for USA standard	see Figs 7 and 8 $C_{\text{deem}} = 6.8 \text{ nF}$	50	–	150	μs
		$C_{\text{deem}} = 10 \text{ nF}$	75	–	225	μs
V_{15-17}	control voltage (pin 15 due to pin 17) in both standards	lower value CR_{deem}	–	0	–	mV
		upper value CR_{deem}	–	–300	–	mV

PLL stereo decoder and noise blanker

TDA1592

SYMBOL	PARAMETER	CONDITIONS	MIN.	TYP.	MAX.	UNIT
HCC (pin 15, pin 7 to GND)						
CR _{deem}	control range of de-emphasis for European standard for USA standard	see Fig.9				
		C _{deem} = 6.8 nF	15	–	90	μs
		C _{deem} = 10 nF	22	–	135	μs
V ₁₅₋₁₇	control voltage (pin 15 due to pin 17) in both standards	lower value CR _{deem}	–	0	–	mV
		upper value CR _{deem}	–	–300	–	mV
ΔV ₁₀ , ΔV ₁₁	DC offset voltage at AF outputs (AM on/off)		–	–	±200	mV
Noise interference detector						
V _{pulse}	trigger sensitivity	τ _{pulse} = 10 μs	–	10	–	mV
ΔV ₈	trigger threshold voltage offset as a function of V _{trigg}	f _{int} = 120 kHz				
		V _{interf.in} = 10 mV	150	200	250	mV
		V _{interf.in} = 100 mV	550	650	750	mV
t _{sup}	AF suppression time; pulse width		–	40	–	μs
I _{13,14}	input offset current (pins 13 and 14)	during AF suppression time	–	20	–	nA

Notes

1. Intermodulation suppression [Beat Frequency Components (BFC)]:

$$IM2 = \frac{V_{o(\text{signal})}(\text{at } 1 \text{ kHz})}{V_{o(\text{spurious})}(\text{at } 1 \text{ kHz})}; f_s = (2 \times 10 \text{ kHz}) - 19 \text{ kHz}$$

$$IM3 = \frac{V_{o(\text{signal})}(\text{at } 1 \text{ kHz})}{V_{o(\text{spurious})}(\text{at } 1 \text{ kHz})}; f_s = (3 \times 13 \text{ kHz}) - 38 \text{ kHz}$$

measured with 91% mono signal; f_{mod} = 10 kHz or 13 kHz; 9% pilot signal.

2. ARI suppression:

$$\alpha_{57}ARI = \frac{V_{o(\text{signal})}(\text{at } 1 \text{ kHz})}{V_{o(\text{spurious})}(\text{at } 1 \text{ kHz} \pm 23 \text{ Hz})}$$

measured with 91% stereo signal; f_{mod} = 1 kHz; 9% pilot signal; 5% ARI subcarrier (f_s = 57 kHz; f_{mod} = 23 Hz; AM m = 0.6).

3. Subsidiary Communication Authorization (SCA):

$$\alpha_{67} = \frac{V_{o(\text{signal})}(\text{at } 1 \text{ kHz})}{V_{o(\text{spurious})}(\text{at } 9 \text{ kHz})}; f_s = (2 \times 38 \text{ kHz}) - 67 \text{ kHz}$$

measured with 81% mono signal; f_{mod} = 1 kHz; 9% pilot signal; 10% SCA subcarrier (f_s = 67 kHz, unmodulated).

4. Adjacent Channel Interference (ACI):

$$\alpha_{114} = \frac{V_{o(\text{signal})}(\text{at } 1 \text{ kHz})}{V_{o(\text{spurious})}(\text{at } 4 \text{ kHz})}; f_s = 110 \text{ kHz} - (3 \times 38 \text{ kHz})$$

$$\alpha_{190} = \frac{V_{o(\text{signal})}(\text{at } 1 \text{ kHz})}{V_{o(\text{spurious})}(\text{at } 4 \text{ kHz})}; f_s = 186 \text{ kHz} - (5 \times 38 \text{ kHz})$$

measured with 90% mono signal; f_{mod} = 1 kHz; 9% pilot signal; 1% spurious signal (f_s = 110 kHz or 186 kHz, unmodulated).

PLL stereo decoder and noise blanker

TDA1592

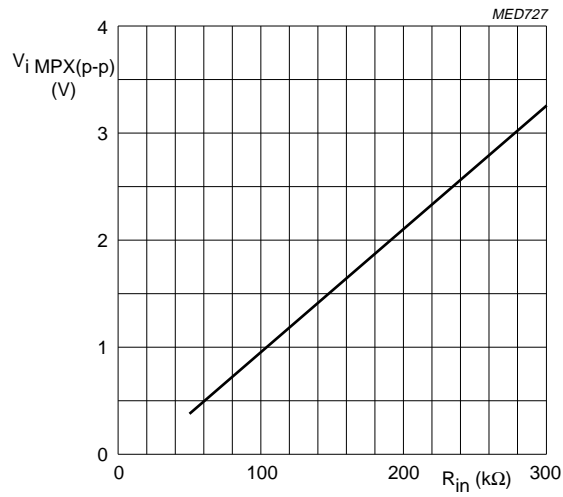

Fig.3 Input signal as a function of series input resistor R_{in} .

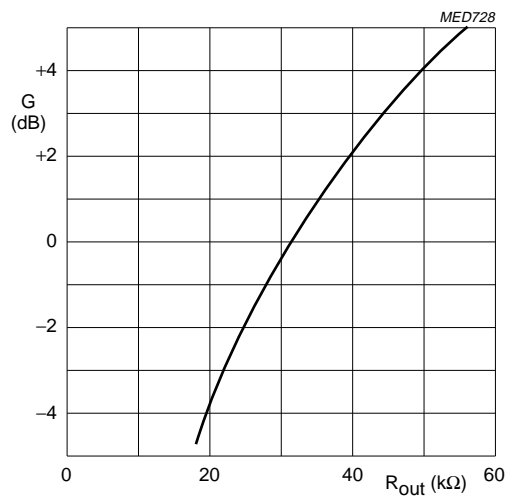
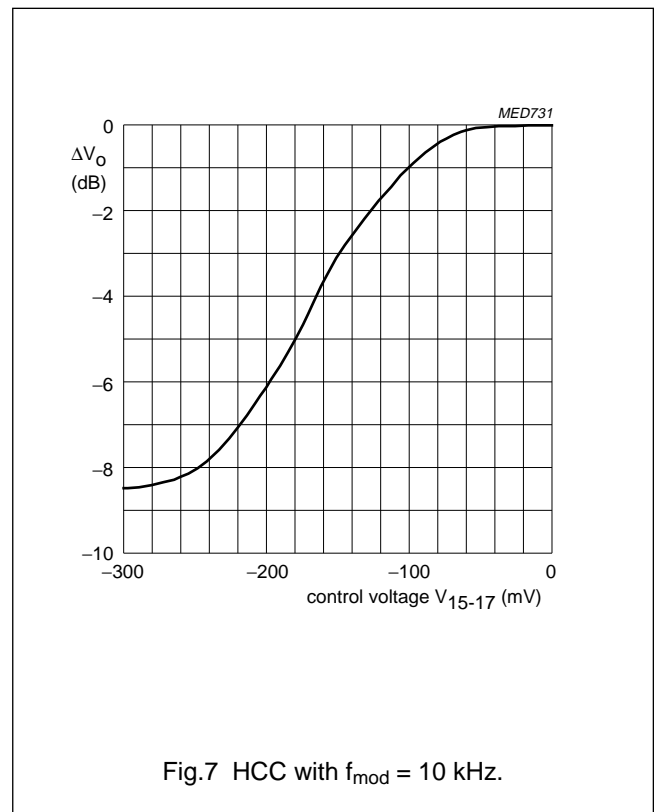
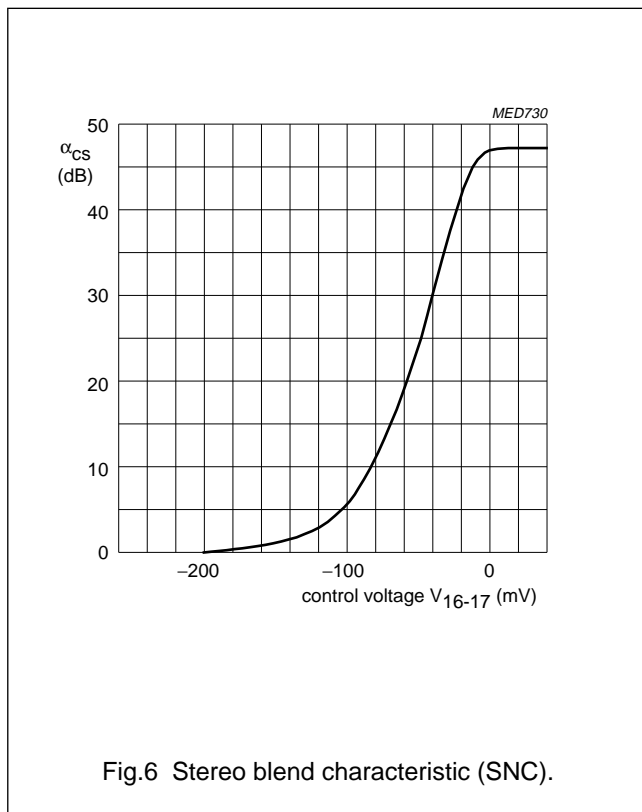
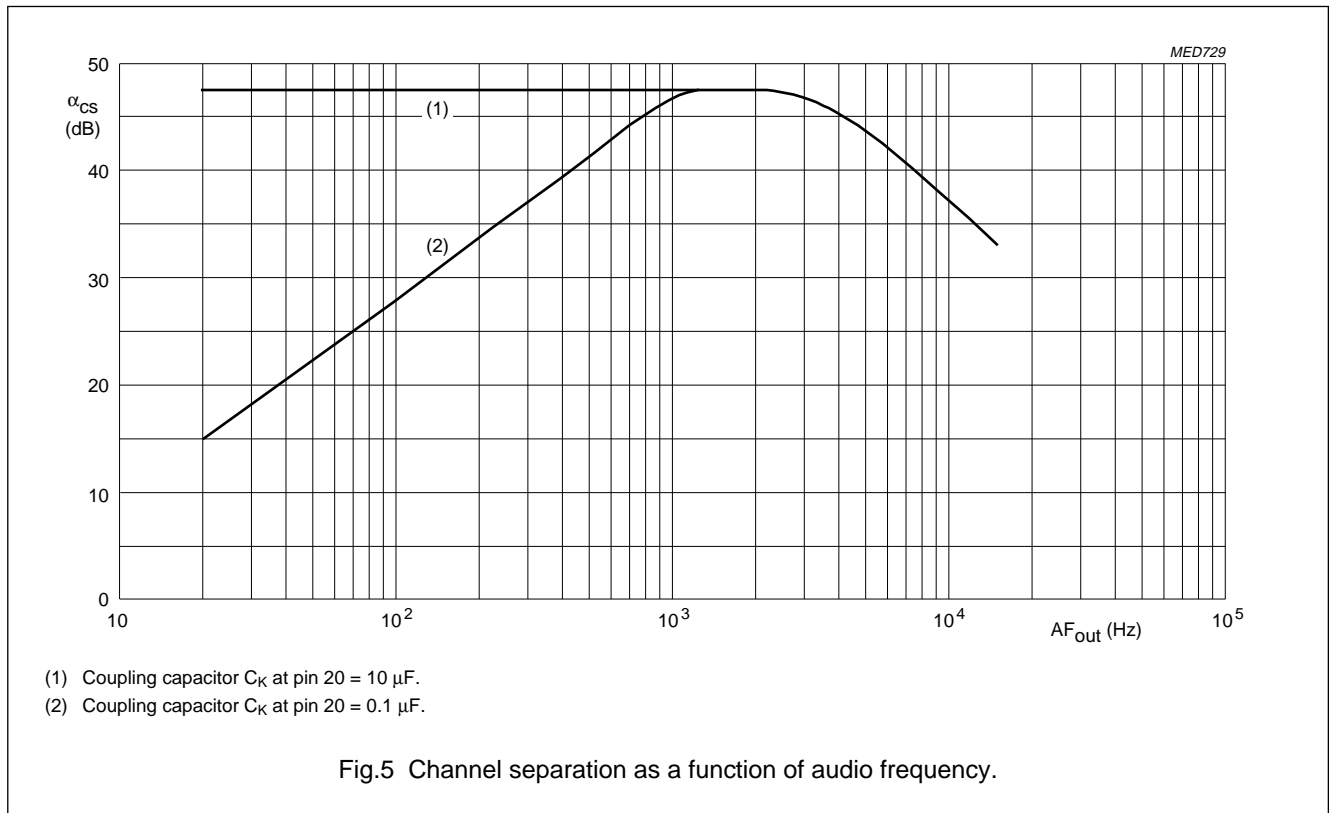

Fig.4 Overall signal gain as a function of feedback resistors R_{out} ($R_{in} = 164$ k Ω).

PLL stereo decoder and noise blanker

TDA1592



PLL stereo decoder and noise blanker

TDA1592

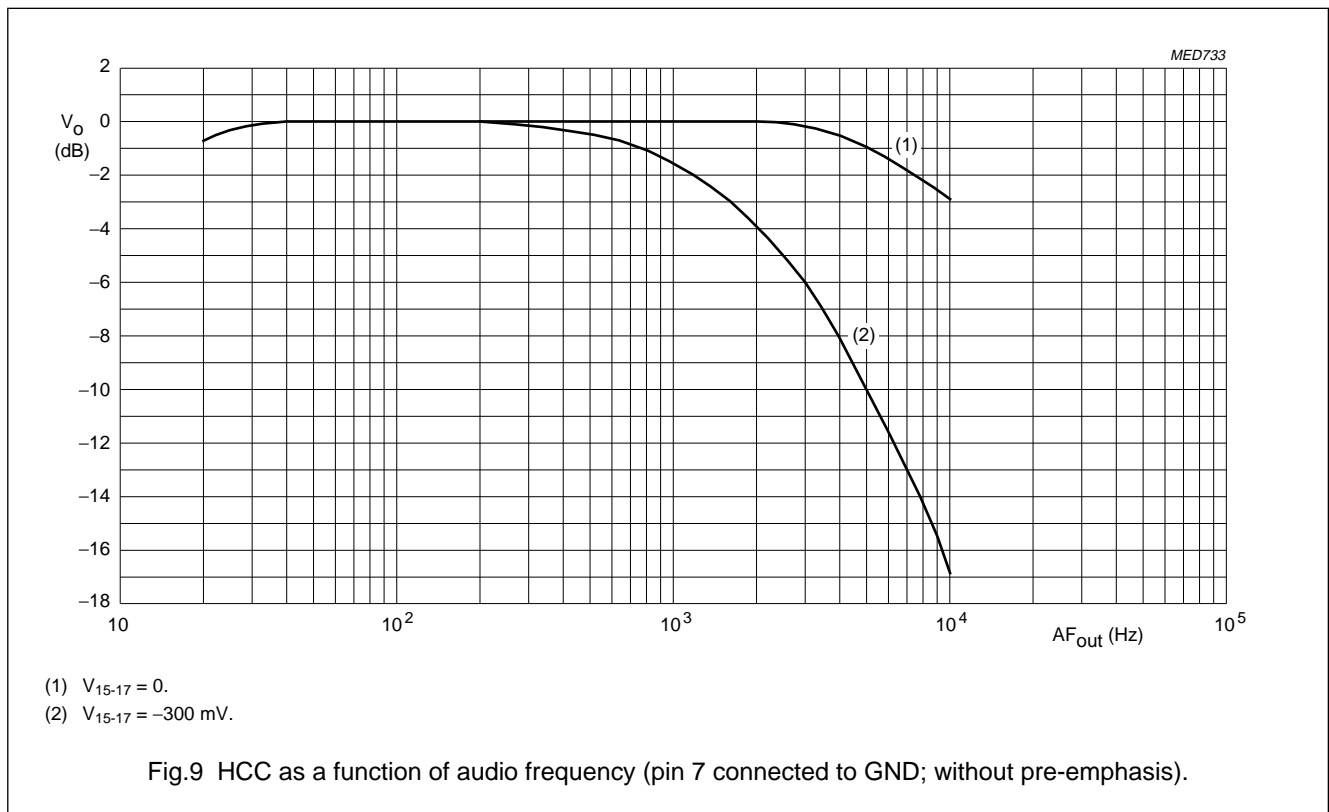
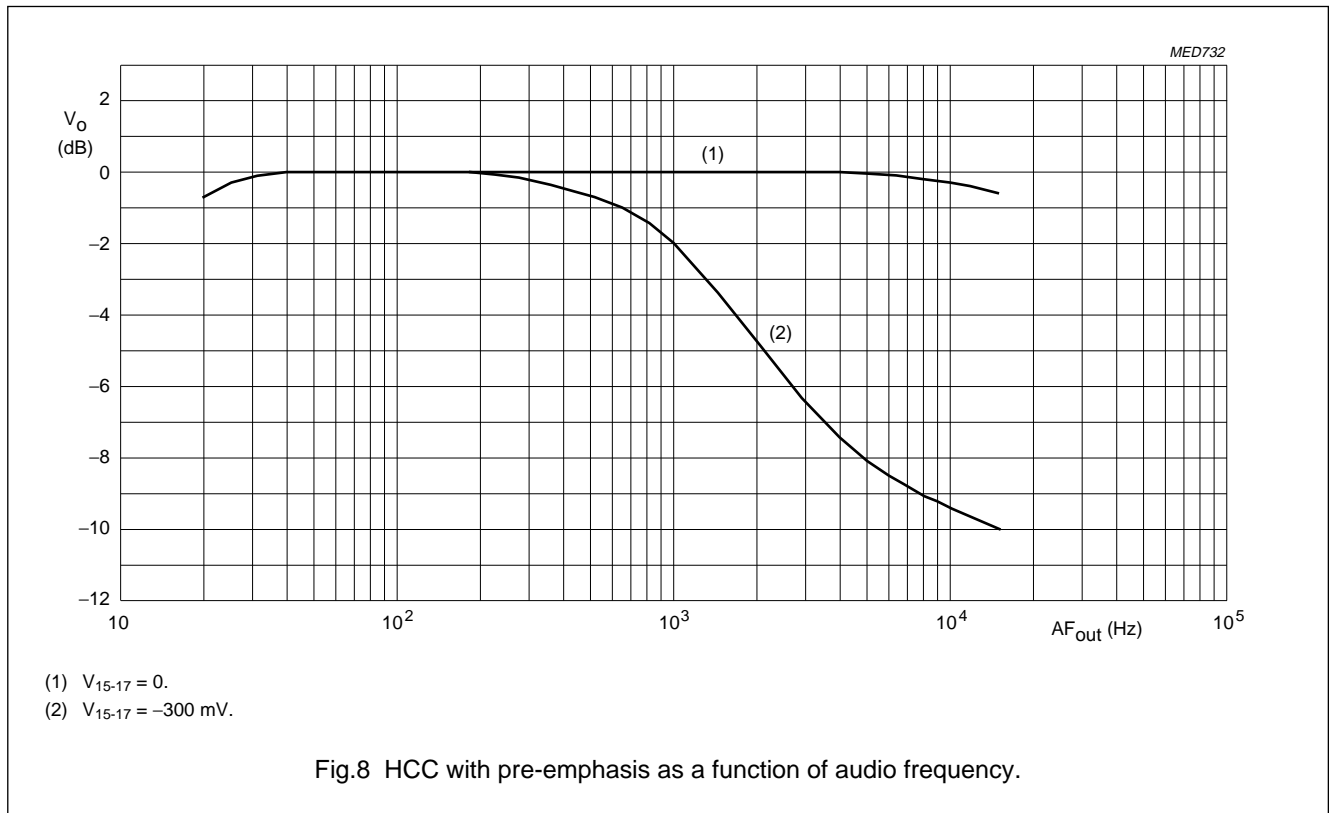

PLL stereo decoder and noise blanker

TDA1592

INTERNAL PIN CONFIGURATION

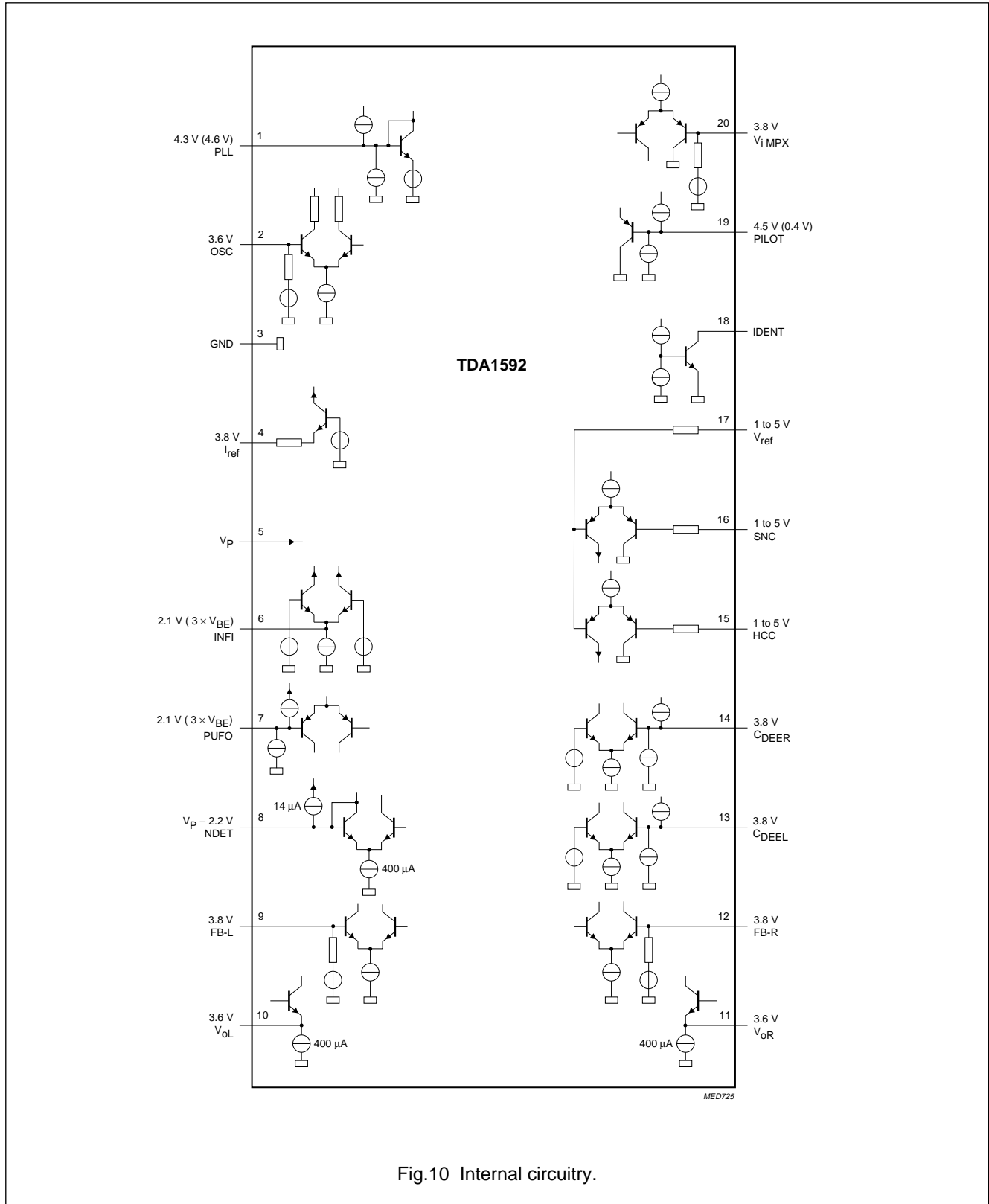

Fig.10 Internal circuitry.

PLL stereo decoder and noise blanker

TDA1592

TEST INFORMATION

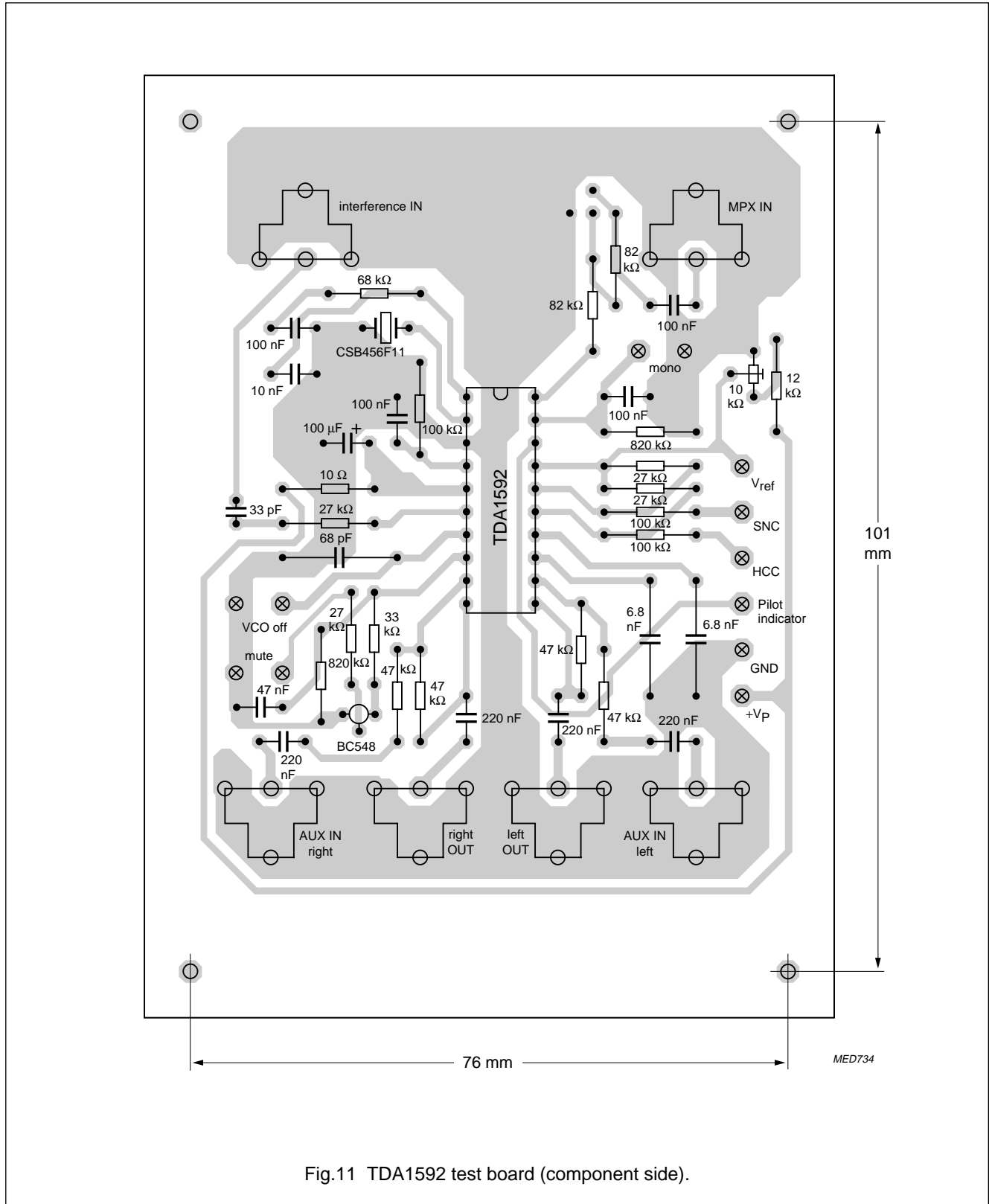

Fig.11 TDA1592 test board (component side).

PLL stereo decoder and noise blanker

TDA1592

PACKAGE OUTLINES

DIP20: plastic dual in-line package; 20 leads (300 mil)

SOT146-1

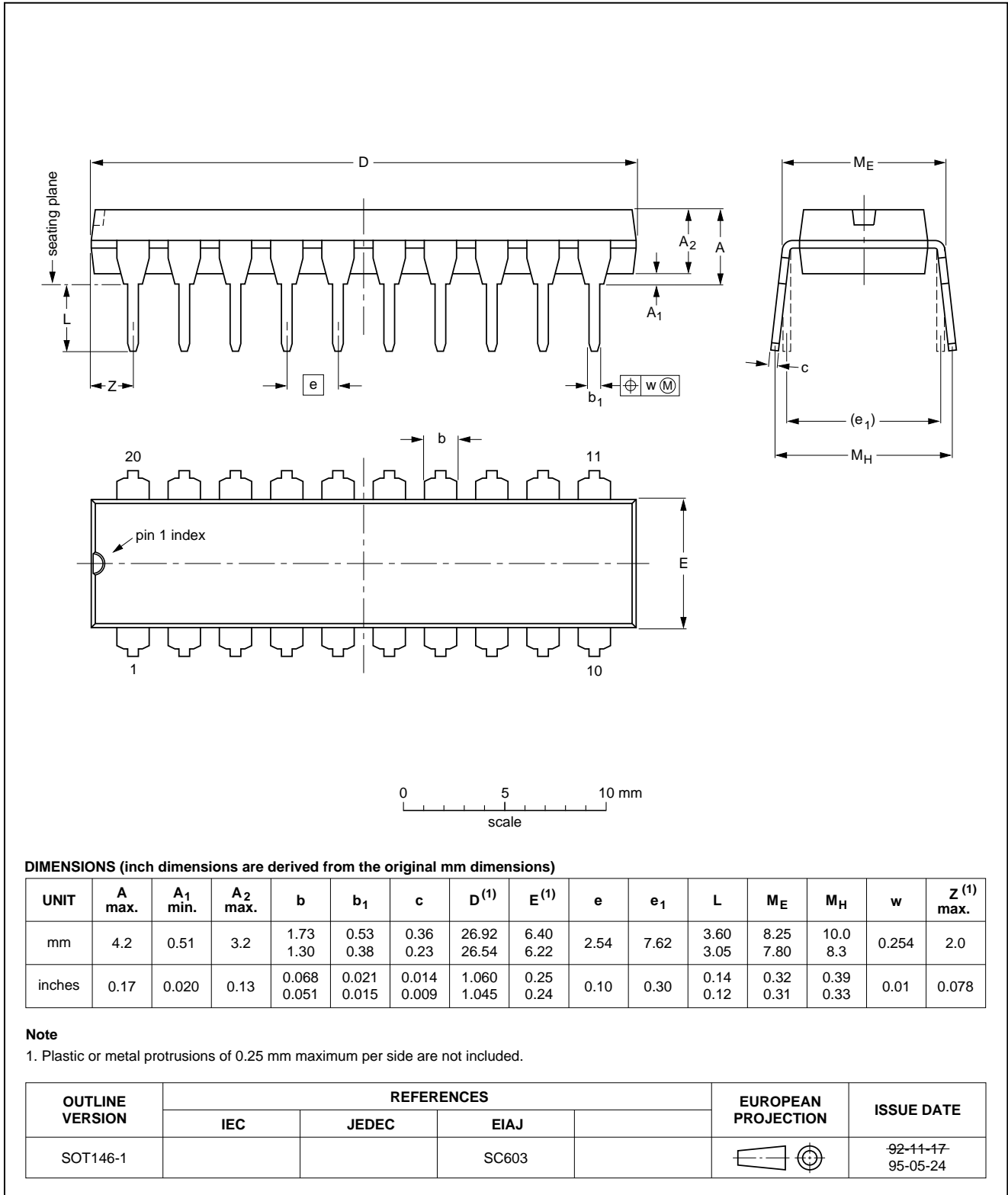

PLL stereo decoder and noise blanker

TDA1592

SO20: plastic small outline package; 20 leads; body width 7.5 mm

SOT163-1

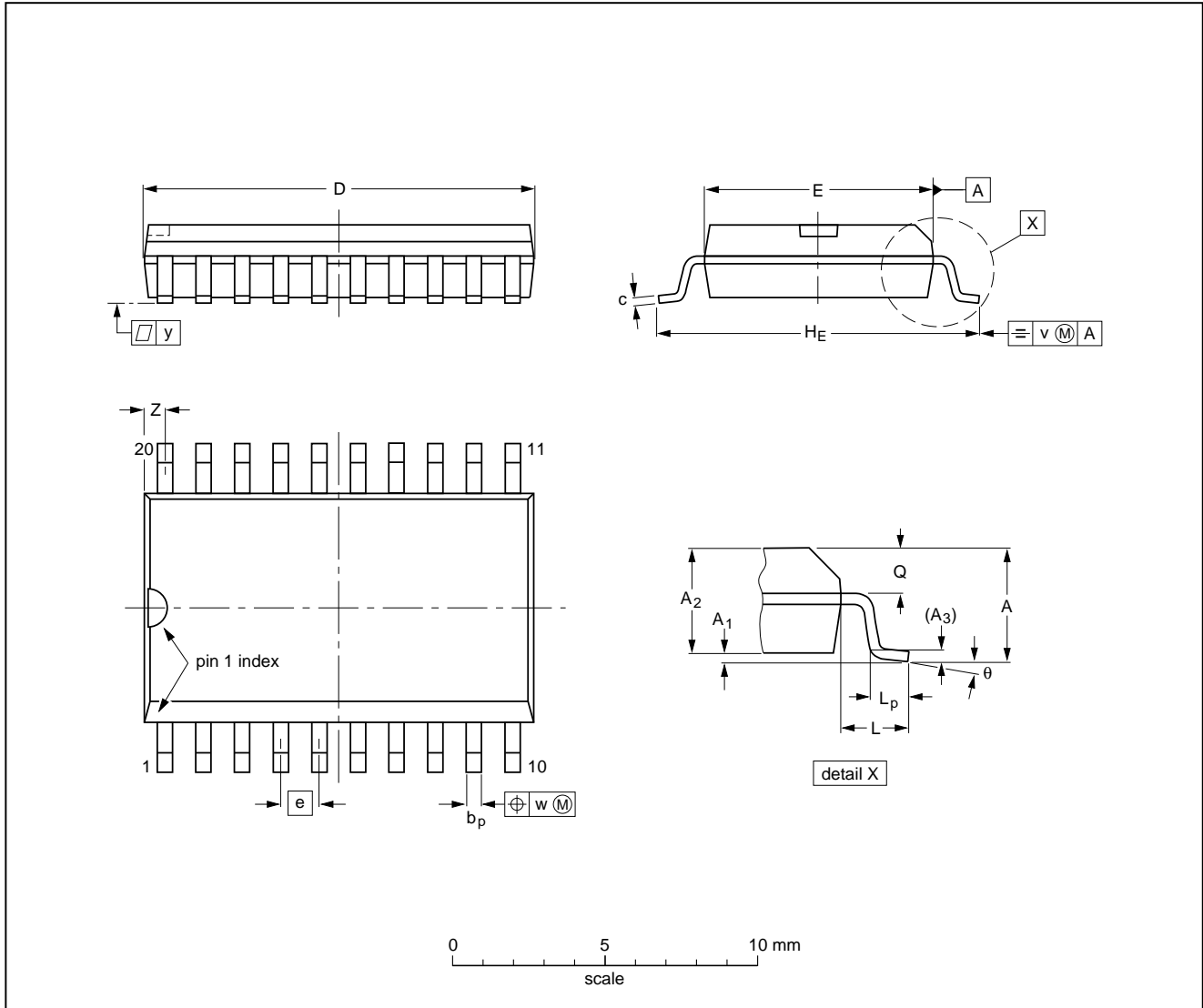

DIMENSIONS (inch dimensions are derived from the original mm dimensions)

UNIT	A max.	A ₁	A ₂	A ₃	b _p	c	D ⁽¹⁾	E ⁽¹⁾	e	H _E	L	L _p	Q	v	w	y	Z ⁽¹⁾	θ
mm	2.65	0.30 0.10	2.45 2.25	0.25	0.49 0.36	0.32 0.23	13.0 12.6	7.6 7.4	1.27	10.65 10.00	1.4	1.1 0.4	1.1 1.0	0.25	0.25	0.1	0.9 0.4	8° 0°
inches	0.10	0.012 0.004	0.096 0.089	0.01	0.019 0.014	0.013 0.009	0.51 0.49	0.30 0.29	0.050	0.42 0.39	0.055	0.043 0.016	0.043 0.039	0.01	0.01	0.004	0.035 0.016	

Note

1. Plastic or metal protrusions of 0.15 mm maximum per side are not included.

OUTLINE VERSION	REFERENCES				EUROPEAN PROJECTION	ISSUE DATE
	IEC	JEDEC	EIAJ			
SOT163-1	075E04	MS-013AC				92-11-17 95-01-24

PLL stereo decoder and noise blanker

TDA1592

SOLDERING

Introduction

There is no soldering method that is ideal for all IC packages. Wave soldering is often preferred when through-hole and surface mounted components are mixed on one printed-circuit board. However, wave soldering is not always suitable for surface mounted ICs, or for printed-circuits with high population densities. In these situations reflow soldering is often used.

This text gives a very brief insight to a complex technology. A more in-depth account of soldering ICs can be found in our "IC Package Databook" (order code 9398 652 90011).

DIP

SOLDERING BY DIPPING OR BY WAVE

The maximum permissible temperature of the solder is 260 °C; solder at this temperature must not be in contact with the joint for more than 5 seconds. The total contact time of successive solder waves must not exceed 5 seconds.

The device may be mounted up to the seating plane, but the temperature of the plastic body must not exceed the specified maximum storage temperature ($T_{stg\ max}$). If the printed-circuit board has been pre-heated, forced cooling may be necessary immediately after soldering to keep the temperature within the permissible limit.

REPAIRING SOLDERED JOINTS

Apply a low voltage soldering iron (less than 24 V) to the lead(s) of the package, below the seating plane or not more than 2 mm above it. If the temperature of the soldering iron bit is less than 300 °C it may remain in contact for up to 10 seconds. If the bit temperature is between 300 and 400 °C, contact may be up to 5 seconds.

SO

REFLOW SOLDERING

Reflow soldering techniques are suitable for all SO packages.

Reflow soldering requires solder paste (a suspension of fine solder particles, flux and binding agent) to be applied to the printed-circuit board by screen printing, stencilling or pressure-syringe dispensing before package placement.

Several techniques exist for reflowing; for example, thermal conduction by heated belt. Dwell times vary between 50 and 300 seconds depending on heating method. Typical reflow temperatures range from 215 to 250 °C.

Preheating is necessary to dry the paste and evaporate the binding agent. Preheating duration: 45 minutes at 45 °C.

WAVE SOLDERING

Wave soldering techniques can be used for all SO packages if the following conditions are observed:

- A double-wave (a turbulent wave with high upward pressure followed by a smooth laminar wave) soldering technique should be used.
- The longitudinal axis of the package footprint must be parallel to the solder flow.
- The package footprint must incorporate solder thieves at the downstream end.

During placement and before soldering, the package must be fixed with a droplet of adhesive. The adhesive can be applied by screen printing, pin transfer or syringe dispensing. The package can be soldered after the adhesive is cured.

Maximum permissible solder temperature is 260 °C, and maximum duration of package immersion in solder is 10 seconds, if cooled to less than 150 °C within 6 seconds. Typical dwell time is 4 seconds at 250 °C.

A mildly-activated flux will eliminate the need for removal of corrosive residues in most applications.

REPAIRING SOLDERED JOINTS

Fix the component by first soldering two diagonally-opposite end leads. Use only a low voltage soldering iron (less than 24 V) applied to the flat part of the lead. Contact time must be limited to 10 seconds at up to 300 °C. When using a dedicated tool, all other leads can be soldered in one operation within 2 to 5 seconds between 270 and 320 °C.

PLL stereo decoder and noise blanker

TDA1592

DEFINITIONS

Data sheet status	
Objective specification	This data sheet contains target or goal specifications for product development.
Preliminary specification	This data sheet contains preliminary data; supplementary data may be published later.
Product specification	This data sheet contains final product specifications.
Limiting values	
Limiting values given are in accordance with the Absolute Maximum Rating System (IEC 134). Stress above one or more of the limiting values may cause permanent damage to the device. These are stress ratings only and operation of the device at these or at any other conditions above those given in the Characteristics sections of the specification is not implied. Exposure to limiting values for extended periods may affect device reliability.	
Application information	
Where application information is given, it is advisory and does not form part of the specification.	

LIFE SUPPORT APPLICATIONS

These products are not designed for use in life support appliances, devices, or systems where malfunction of these products can reasonably be expected to result in personal injury. Philips customers using or selling these products for use in such applications do so at their own risk and agree to fully indemnify Philips for any damages resulting from such improper use or sale.

PLL stereo decoder and noise blanker

TDA1592

NOTES

PLL stereo decoder and noise blanker

TDA1592

NOTES

Philips Semiconductors – a worldwide company

Argentina: see South America

Australia: 34 Waterloo Road, NORTH RYDE, NSW 2113,
Tel. +61 2 805 4455, Fax. +61 2 805 4466

Austria: Computerstr. 6, A-1101 WIEN, P.O. Box 213,
Tel. +43 1 60 101, Fax. +43 1 60 101 1210

Belarus: Hotel Minsk Business Center, Bld. 3, r. 1211, Volodarski Str. 6,
220050 MINSK, Tel. +375 172 200 733, Fax. +375 172 200 773

Belgium: see The Netherlands

Brazil: see South America

Bulgaria: Philips Bulgaria Ltd., Energoproject, 15th floor,
51 James Bourchier Blvd., 1407 SOFIA,
Tel. +359 2 689 211, Fax. +359 2 689 102

Canada: PHILIPS SEMICONDUCTORS/COMPONENTS,
Tel. +1 800 234 7381, Fax. +1 708 296 8556

China/Hong Kong: 501 Hong Kong Industrial Technology Centre,
72 Tat Chee Avenue, Kowloon Tong, HONG KONG,
Tel. +852 2319 7888, Fax. +852 2319 7700

Colombia: see South America

Czech Republic: see Austria

Denmark: Prags Boulevard 80, PB 1919, DK-2300 COPENHAGEN S,
Tel. +45 32 88 2636, Fax. +45 31 57 1949

Finland: Sinikalliontie 3, FIN-02630 ESPOO,
Tel. +358 615 800, Fax. +358 615 80920

France: 4 Rue du Port-aux-Vins, BP317, 92156 SURESNES Cedex,
Tel. +33 1 40 99 6161, Fax. +33 1 40 99 6427

Germany: Hammerbrookstraße 69, D-20097 HAMBURG,
Tel. +49 40 23 52 60, Fax. +49 40 23 536 300

Greece: No. 15, 25th March Street, GR 17778 TAVROS,
Tel. +30 1 4894 339/911, Fax. +30 1 4814 240

Hungary: see Austria

India: Philips INDIA Ltd, Shivsagar Estate, A Block, Dr. Annie Besant Rd.
Worli, MUMBAI 400 018, Tel. +91 22 4938 541, Fax. +91 22 4938 722

Indonesia: see Singapore

Ireland: Newstead, Clonskeagh, DUBLIN 14,
Tel. +353 1 7640 000, Fax. +353 1 7640 200

Israel: RAPAC Electronics, 7 Kehilat Saloniki St, TEL AVIV 61180,
Tel. +972 3 645 0444, Fax. +972 3 648 1007

Italy: PHILIPS SEMICONDUCTORS, Piazza IV Novembre 3,
20124 MILANO, Tel. +39 2 6752 2531, Fax. +39 2 6752 2557

Japan: Philips Bldg 13-37, Kohnan 2-chome, Minato-ku, TOKYO 108,
Tel. +81 3 3740 5130, Fax. +81 3 3740 5077

Korea: Philips House, 260-199 Itaewon-dong, Yongsan-ku, SEOUL,
Tel. +82 2 709 1412, Fax. +82 2 709 1415

Malaysia: No. 76 Jalan Universiti, 46200 PETALING JAYA, SELANGOR,
Tel. +60 3 750 5214, Fax. +60 3 757 4880

Mexico: 5900 Gateway East, Suite 200, EL PASO, TEXAS 79905,
Tel. +1 800 234 7381, Fax. +1 708 296 8556

Middle East: see Italy

Netherlands: Postbus 90050, 5600 PB EINDHOVEN, Bldg. VB,
Tel. +31 40 27 83749, Fax. +31 40 27 88399

New Zealand: 2 Wagener Place, C.P.O. Box 1041, AUCKLAND,
Tel. +64 9 849 4160, Fax. +64 9 849 7811

Norway: Box 1, Manglerud 0612, OSLO,
Tel. +47 22 74 8000, Fax. +47 22 74 8341

Philippines: Philips Semiconductors Philippines Inc.,
106 Valero St. Salcedo Village, P.O. Box 2108 MCC, MAKATI,
Metro MANILA, Tel. +63 2 816 6380, Fax. +63 2 817 3474

Poland: Ul. Lukiska 10, PL 04-123 WARSZAWA,
Tel. +48 22 612 2831, Fax. +48 22 612 2327

Portugal: see Spain

Romania: see Italy

Russia: Philips Russia, Ul. Usatcheva 35A, 119048 MOSCOW,
Tel. +7 095 926 5361, Fax. +7 095 564 8323

Singapore: Lorong 1, Toa Payoh, SINGAPORE 1231,
Tel. +65 350 2538, Fax. +65 251 6500

Slovakia: see Austria

Slovenia: see Italy

South Africa: S.A. PHILIPS Pty Ltd., 195-215 Main Road Martindale,
2092 JOHANNESBURG, P.O. Box 7430 Johannesburg 2000,
Tel. +27 11 470 5911, Fax. +27 11 470 5494

South America: Rua do Rocio 220 - 5th floor, Suite 51,
CEP: 04552-903-SÃO PAULO-SP, Brazil, P.O. Box 7383 (01064-970),
Tel. +55 11 821 2333, Fax. +55 11 829 1849

Spain: Balmes 22, 08007 BARCELONA,
Tel. +34 3 301 6312, Fax. +34 3 301 4107

Sweden: Kottbygatan 7, Akalla, S-16485 STOCKHOLM,
Tel. +46 8 632 2000, Fax. +46 8 632 2745

Switzerland: Allmendstrasse 140, CH-8027 ZÜRICH,
Tel. +41 1 488 2686, Fax. +41 1 481 7730

Taiwan: PHILIPS TAIWAN Ltd., 23-30F, 66,
Chung Hsiao West Road, Sec. 1, P.O. Box 22978,
TAIPEI 100, Tel. +886 2 382 4443, Fax. +886 2 382 4444

Thailand: PHILIPS ELECTRONICS (THAILAND) Ltd.,
209/2 Sanpavuth-Bangna Road Prakanong, BANGKOK 10260,
Tel. +66 2 745 4090, Fax. +66 2 398 0793

Turkey: Talatpasa Cad. No. 5, 80640 GÜLTEPE/ISTANBUL,
Tel. +90 212 279 2770, Fax. +90 212 282 6707

Ukraine: PHILIPS UKRAINE, 2A Akademika Koroleva str., Office 165,
252148 KIEV, Tel. +380 44 476 0297/1642, Fax. +380 44 476 6991

United Kingdom: Philips Semiconductors Ltd., 276 Bath Road, Hayes,
MIDDLESEX UB3 5BX, Tel. +44 181 730 5000, Fax. +44 181 754 8421

United States: 811 East Arques Avenue, SUNNYVALE, CA 94088-3409,
Tel. +1 800 234 7381, Fax. +1 708 296 8556

Uruguay: see South America

Vietnam: see Singapore

Yugoslavia: PHILIPS, Trg N. Pasica 5/v, 11000 BEOGRAD,
Tel. +381 11 825 344, Fax. +381 11 635 777

For all other countries apply to: Philips Semiconductors, Marketing & Sales Communications, Building BE-p, P.O. Box 218, 5600 MD EINDHOVEN, The Netherlands, Fax. +31 40 27 24825

Internet: <http://www.semiconductors.philips.com/ps/>

© Philips Electronics N.V. 1996

SCA49

All rights are reserved. Reproduction in whole or in part is prohibited without the prior written consent of the copyright owner.

The information presented in this document does not form part of any quotation or contract, is believed to be accurate and reliable and may be changed without notice. No liability will be accepted by the publisher for any consequence of its use. Publication thereof does not convey nor imply any license under patent- or other industrial or intellectual property rights.

Printed in The Netherlands

517021/1200/02/pp20

Date of release: 1996 May 31

Document order number: 9397 750 00875

Let's make things better.

**Philips
Semiconductors**



PHILIPS