

NPN Silicon Germanium RF Transistor

- High gain low noise RF transistor
- Provides outstanding performance for a wide range of wireless applications
- Ideal for CDMA and WLAN applications
- Outstanding noise figure $F = 0.65$ dB at 1.8 GHz
Outstanding noise figure $F = 1.3$ dB at 6 GHz
- High maximum stable gain
 $G_{ms} = 24$ dB at 1.8 GHz
- Gold metallization for extra high reliability
- 70 GHz f_T -Silicon Germanium technology

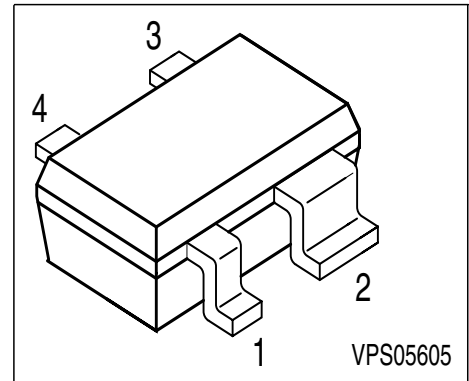

ESD: Electrostatic discharge sensitive device, observe handling precaution!

Type	Marking	Pin Configuration						Package
BFP640	R4s	1=B	2=E	3=C	4=E	-	-	SOT343

Maximum Ratings

Parameter	Symbol	Value	Unit
Collector-emitter voltage	V_{CEO}		V
$T_A > 0$ °C		4	
$T_A \leq 0$ °C		3.7	
Collector-emitter voltage	V_{CES}	13	
Collector-base voltage	V_{CBO}	13	
Emitter-base voltage	V_{EBO}	1.2	
Collector current	I_C	50	mA
Base current	I_B	3	
Total power dissipation ¹⁾	P_{tot}	200	mW
$T_S \leq 90$ °C			
Junction temperature	T_j	150	°C
Ambient temperature	T_A	-65 ... 150	
Storage temperature	T_{stg}	-65 ... 150	

¹⁾ T_S is measured on the collector lead at the soldering point to the pcb

Thermal Resistance

Parameter	Symbol	Value	Unit
Junction - soldering point ¹⁾	R_{thJS}	≤ 300	K/W

Electrical Characteristics at $T_A = 25^\circ\text{C}$, unless otherwise specified

Parameter	Symbol	Values			Unit
		min.	typ.	max.	

DC Characteristics

Collector-emitter breakdown voltage $I_C = 1 \text{ mA}, I_B = 0$	$V_{(BR)CEO}$	4	4.5	-	V
Collector-emitter cutoff current $V_{CE} = 13 \text{ V}, V_{BE} = 0$	I_{CES}	-	-	30	μA
Collector-base cutoff current $V_{CB} = 5 \text{ V}, I_E = 0$	I_{CBO}	-	-	100	nA
Emitter-base cutoff current $V_{EB} = 0.5 \text{ V}, I_C = 0$	I_{EBO}	-	-	3	μA
DC current gain $I_C = 30 \text{ mA}, V_{CE} = 3 \text{ V}, \text{ pulse measured}$	h_{FE}	110	180	270	-

¹⁾For calculation of R_{thJA} please refer to Application Note Thermal Resistance

Electrical Characteristics at $T_A = 25^\circ\text{C}$, unless otherwise specified

Parameter	Symbol	Values			Unit
		min.	typ.	max.	
AC Characteristics (verified by random sampling)					
Transition frequency $I_C = 30\text{ mA}$, $V_{CE} = 3\text{ V}$, $f = 1\text{ GHz}$	f_T	30	40	-	GHz
Collector-base capacitance $V_{CB} = 3\text{ V}$, $f = 1\text{ MHz}$	C_{cb}	-	0.09	0.2	pF
Collector emitter capacitance $V_{CE} = 3\text{ V}$, $f = 1\text{ MHz}$	C_{ce}	-	0.23	-	
Emitter-base capacitance $V_{EB} = 0.5\text{ V}$, $f = 1\text{ MHz}$	C_{eb}	-	0.5	-	
Noise figure $I_C = 5\text{ mA}$, $V_{CE} = 3\text{ V}$, $f = 1.8\text{ GHz}$, $Z_S = Z_{Sopt}$ $I_C = 5\text{ mA}$, $V_{CE} = 3\text{ V}$, $f = 6\text{ GHz}$, $Z_S = Z_{Sopt}$	F	-	0.65 1.3	-	dB
Power gain, maximum stable ¹⁾ $I_C = 30\text{ mA}$, $V_{CE} = 3\text{ V}$, $Z_S = Z_{Sopt}$, $Z_L = Z_{Lopt}$, $f = 1.8\text{ GHz}$	G_{ms}	-	24	-	dB
Power gain, maximum available ¹⁾ $I_C = 30\text{ mA}$, $V_{CE} = 3\text{ V}$, $Z_S = Z_{Sopt}$, $Z_L = Z_{Lopt}$, $f = 6\text{ GHz}$	G_{ma}	-	12.5	-	dB
Transducer gain $I_C = 30\text{ mA}$, $V_{CE} = 3\text{ V}$, $Z_S = Z_L = 50\ \Omega$, $f = 1.8\text{ GHz}$ $I_C = 30\text{ mA}$, $V_{CE} = 3\text{ V}$, $Z_S = Z_L = 50\ \Omega$, $f = 6\text{ GHz}$	$ S_{21e} ^2$	-	21 10.5	-	dB
Third order intercept point at output ²⁾ $V_{CE} = 3\text{ V}$, $I_C = 30\text{ mA}$, $f = 1.8\text{ GHz}$, $Z_S = Z_L = 50\ \Omega$	IP_3	-	26.5	-	dBm
1dB Compression point at output $I_C = 30\text{ mA}$, $V_{CE} = 3\text{ V}$, $Z_S = Z_L = 50\ \Omega$, $f = 1.8\text{ GHz}$	P_{-1dB}	-	13	-	

¹⁾ $G_{ma} = |S_{21e} / S_{12e}| (k - (k^2 - 1)^{1/2})$, $G_{ms} = |S_{21e} / S_{12e}|$
²⁾ IP_3 value depends on termination of all intermodulation frequency components.
Termination used for this measurement is $50\ \Omega$ from 0.1 MHz to 6 GHz

SPICE Parameter (Gummel-Poon Model, Berkley-SPICE 2G.6 Syntax):
Transistor Chip Data:

IS =	0.22	fA	BF =	450	-	NF =	1.025	-
VAF =	1000	V	IKF =	0.15	A	ISE =	21	fA
NE =	2	-	BR =	55	-	NR =	1	-
VAR =	2	V	IKR =	3.8	mA	ISC =	400	fA
NC =	1.8	-	RB =	3.129	Ω	IRB =	1.522	mA
RBM =	2.707	Ω	RE =	0.6	-	RC =	3.061	Ω
CJE =	227.6	fF	VJE =	0.8	V	MJE =	0.3	-
TF =	1.8	ps	XTF =	10	-	VTF =	1.5	V
ITF =	0.4	A	PTF =	0	deg	CJC =	67.43	fF
VJC =	0.6	V	MJC =	0.5	-	XCJC =	1	-
TR =	0.2	ns	CJS =	93.4	fF	VJS =	0.6	V
MJS =	0.27	-	XTB =	-1.42	-	EG =	1.078	eV
XTI =	3	-	FC =	0.8	-	TNOM	298	K
AF =	2	-	KF =	7.291E-11	-			
TITF1	-0.0065	-	TITF2	1.0E-5	-			

All parameters are ready to use, no scaling is necessary. Extracted on behalf of Infineon Technologies AG by: Institut für Mobil- und Satellitentechnik (IMST)

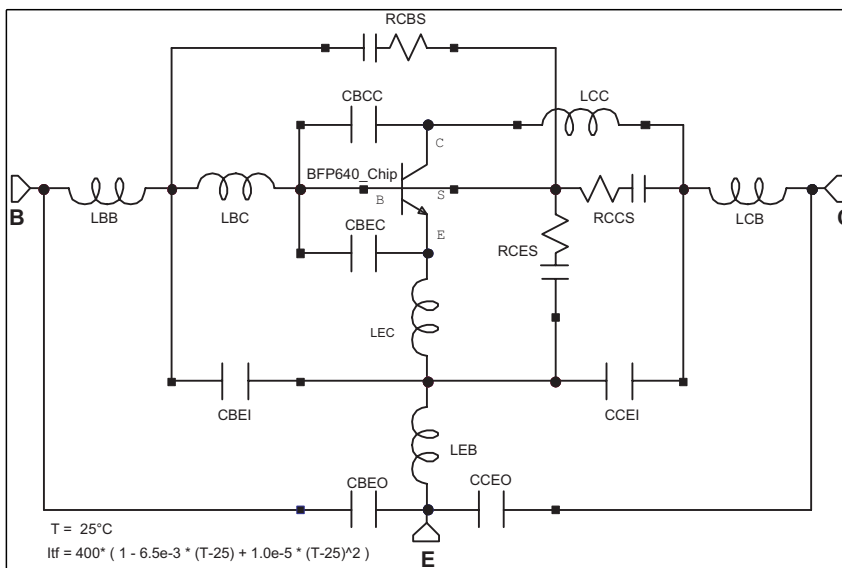
Package Equivalent Circuit:

LBC =	120	pH
LCC =	120	pH
LEC =	20	pH
LBB =	696.2	pH
LCB =	682.4	pH
LEB =	230.6	pH
CBEC =	98.4	fF
CBCC =	55.9	fF
CES =	180	fF
CBS =	79	fF
CCS =	75	fF
CCEO =	131.2	fF
CBEI =	102.5	fF
CCEI =	112.6	fF
CBEI =	180.4	fF
RBS =	1200	Ω
RCS =	1200	Ω
RES =	300	Ω

For examples and ready to use parameters please contact your local Infineon Technologies distributor or sales office to obtain a Infineon Technologies CD-ROM or see Internet: <http://www.infineon.com/silicondiscretet>

Valid up to 6GHz

Total power dissipation $P_{tot} = f(T_S)$

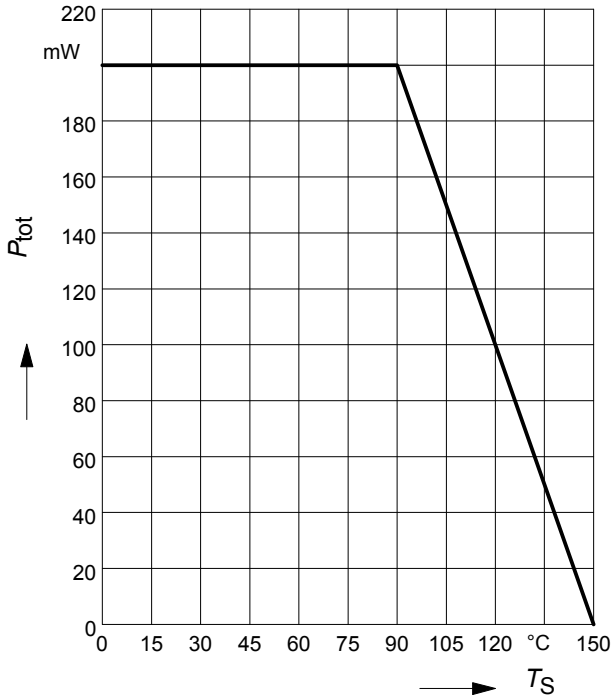

Permissible Pulse Load $R_{thJS} = f(t_p)$

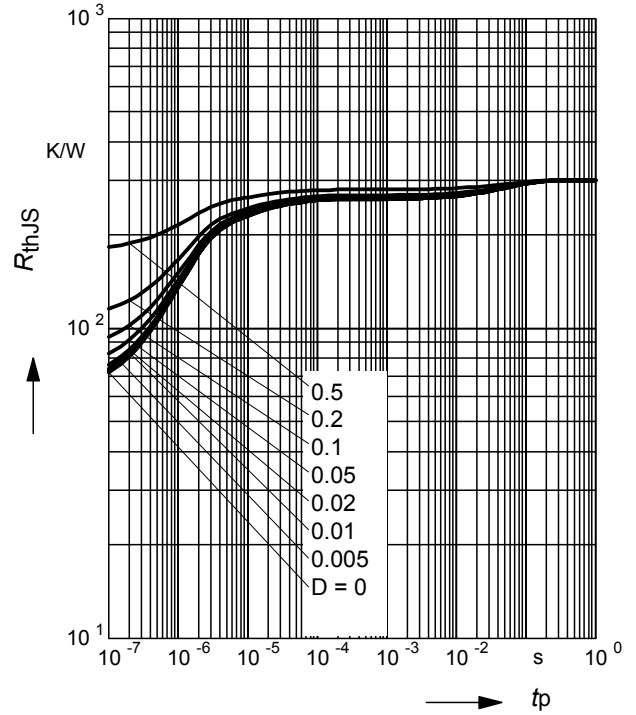

Permissible Pulse Load

$P_{totmax}/P_{totDC} = f(t_p)$

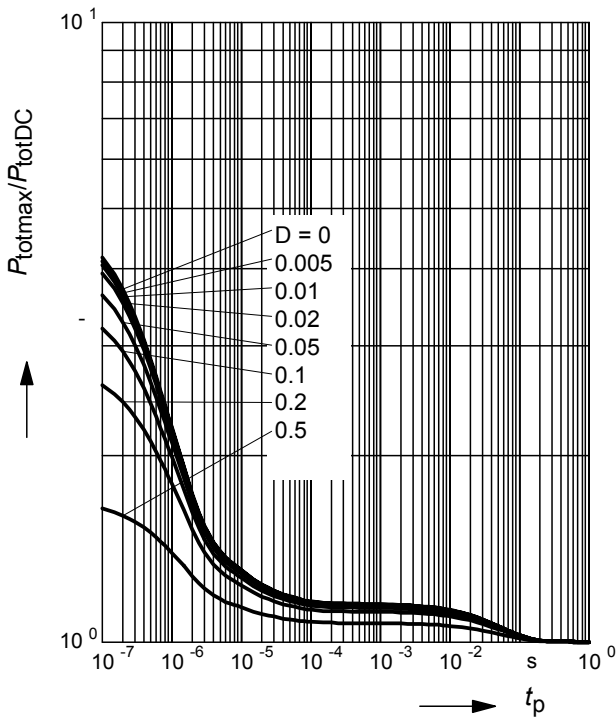

Collector-base capacitance $C_{cb} = f(V_{CB})$

$f = 1\text{MHz}$

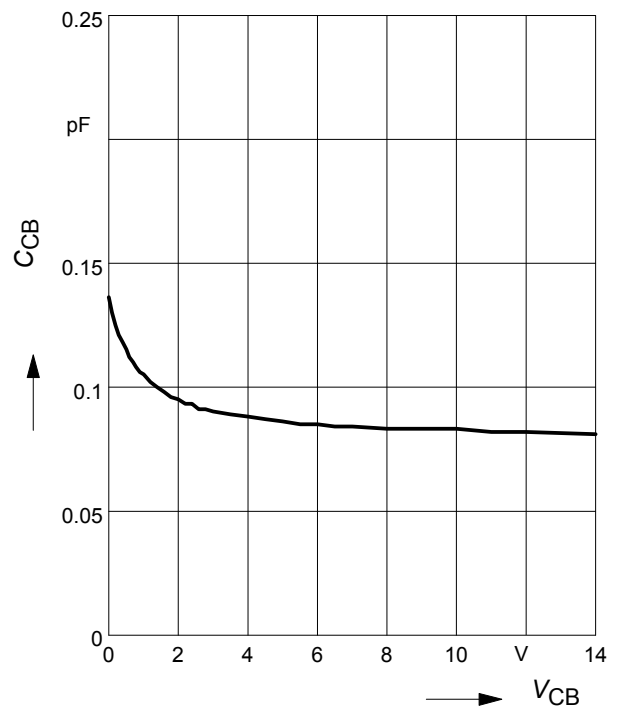

Third order Intercept Point $IP_3=f(I_C)$

(Output, $Z_S=Z_L=50\Omega$)

V_{CE} = parameter, $f = 1.8\text{ GHz}$

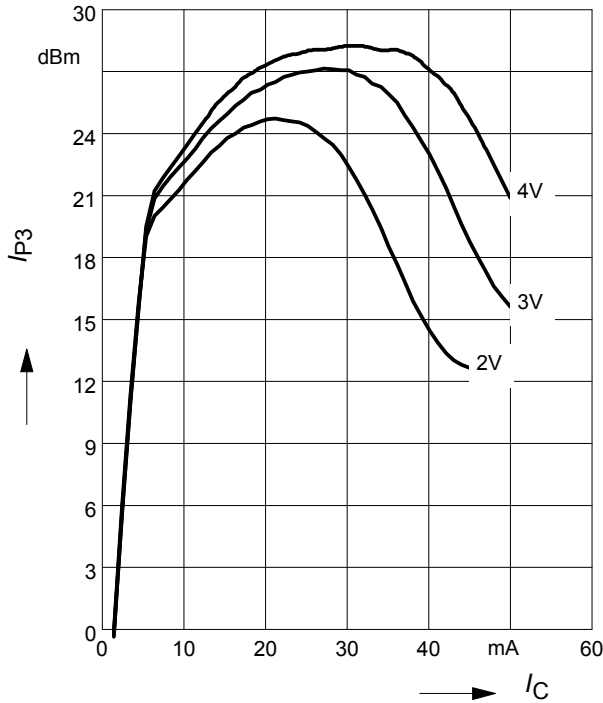

Transition frequency $f_T=f(I_C)$

$f = 1\text{ GHz}$

V_{CE} = parameter

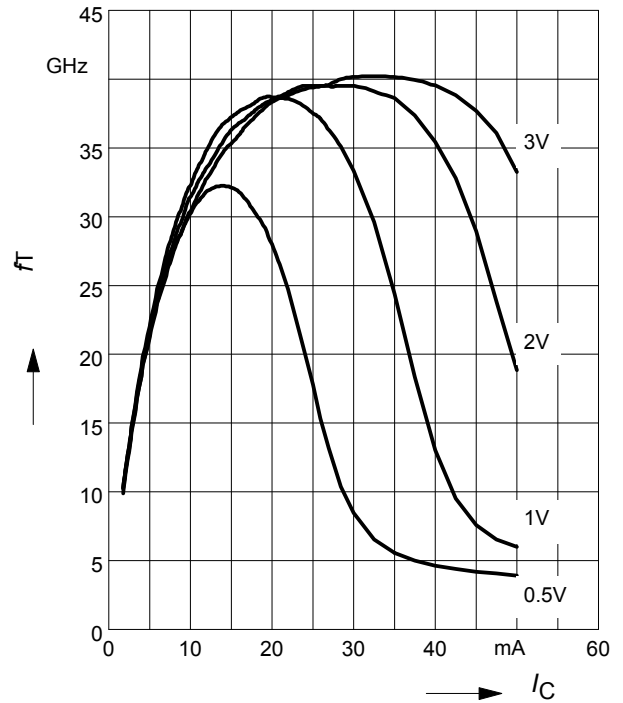

Power gain $G_{ma}, G_{ms} = f(I_C)$

$V_{CE} = 3\text{ V}$

$f =$ parameter

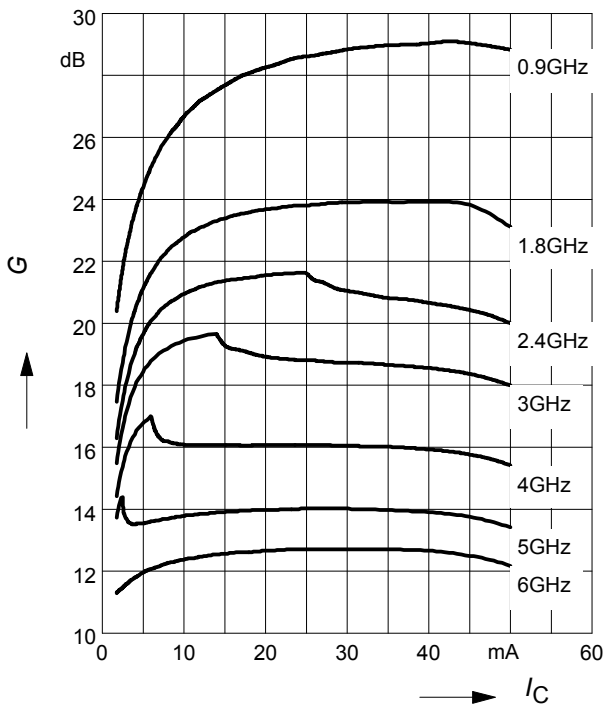

Power Gain $G_{ma}, G_{ms} = f(f)$

$|S_{21}|^2 = f(f)$

$V_{CE} = 3\text{ V}, I_C = 30\text{ mA}$

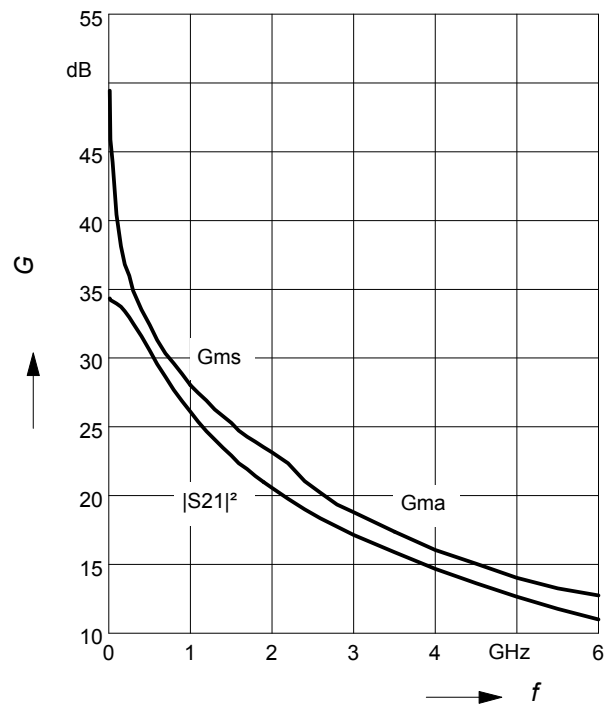

Power gain G_{ma} , $G_{ms} = f(V_{CE})$

$I_C = 30\text{mA}$

$f = \text{parameter}$

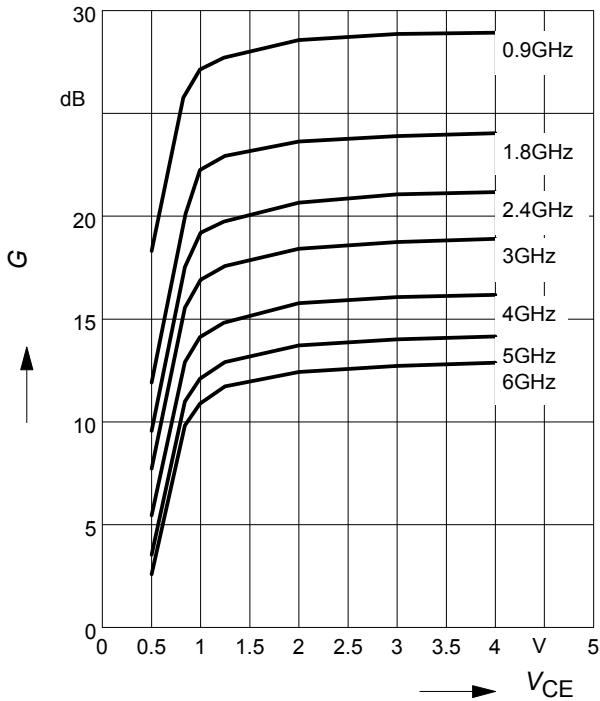

Noise figure $F = f(I_C)$

$V_{CE} = 3\text{V}$, $Z_S = Z_{Sopt}$

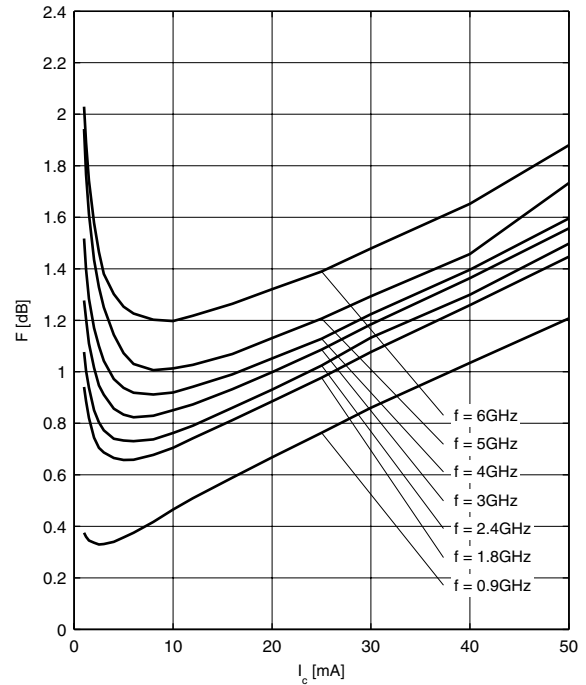

Noise figure $F = f(I_C)$

$V_{CE} = 3\text{V}$, $f = 1.8\text{GHz}$

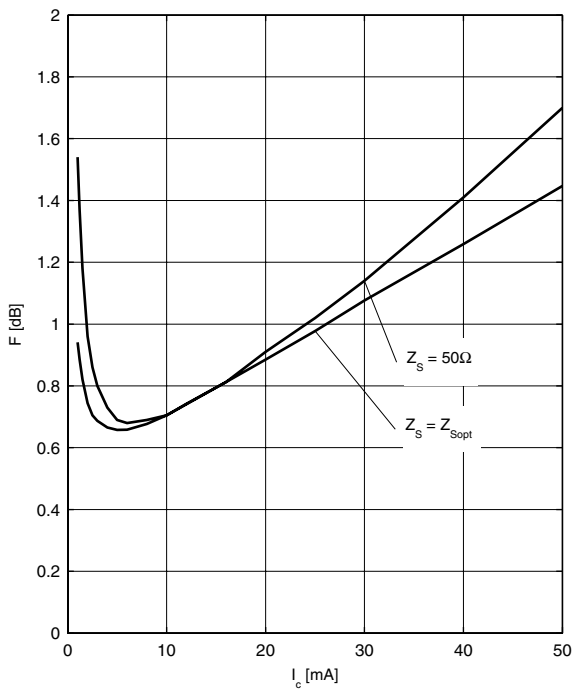

Noise figure $F = f(f)$

$V_{CE} = 3\text{V}$, $Z_S = Z_{Sopt}$

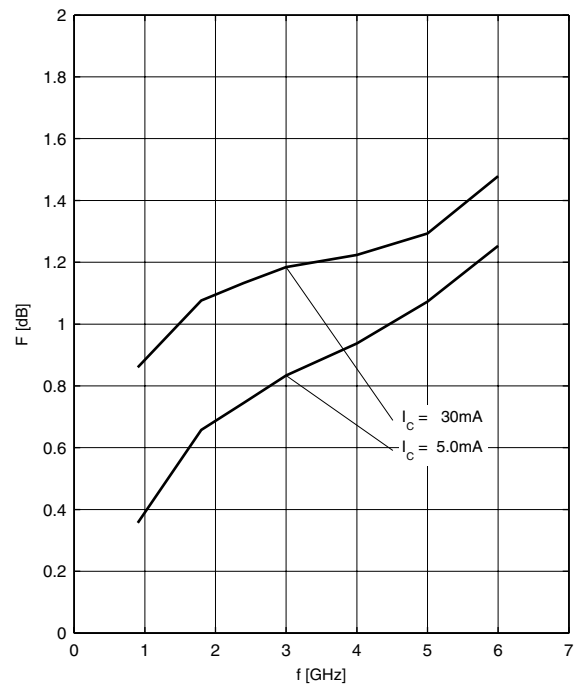

Source impedance for min.

noise figure vs. frequency

$V_{CE} = 3\text{ V}$, $I_C = 5\text{ mA}/30\text{ mA}$

